

FLOS

F1070009 White

Bellhop Floor

Designed by Edward Barber and Jay Osgerby, 2020

26W - 1232lm - 2700K - CRI> 90



Floor lamp with indirect light. Stem in painted aluminium: shiny white, brick, cioko, green. Reflector in shiny opal white and grey blown glass. Electrical cable of 270 cm usable length with foot dimmer switch for ON/OFF function and brightness adjustment 10–100%. Power supply with interchangeable plugs.

Are you a professional and your project needs consulting and support?

[BOOK AN APPOINTMENT](#)

Main specifications

EAN	8059607039694
Mounting	Floor
Environments	Indoor dry location
Light Source Type	LED
LED type	LED array
Power (W)	26
System power (W)	26
System flux (lm)	1232

Physical

Colour	White
Length (mm)	260
Cord length (mm)	2700
Net weight (kg)	9.82
Package height (mm)	0
Package width (mm)	0
Package length (mm)	0
Package volume (m3)	0.05
IP internal	20
IP external	20

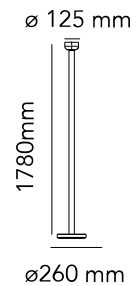

Download

Mounting instructions	↓ PDF
Mounting instructions	↓ PDF
Spare Parts	↓ PDF

Photometric Files

LDT / IES	↓ LDT
-----------	-----------------------

Technical Drawings

3D	↓ ZIP
Bim	↓ ZIP



Schematic light drawing

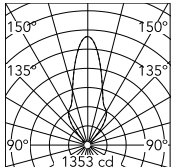

Beam Angle: 33°

h(m)	E(lx)	D(m)
1	1353	0.58
2	338	1.17
3	150	1.75
4	85	2.34
5	54	2.92

Luminous flux Luminaire
1023 lm

Photometric

Lighting type	Indirect
Light distribution	Roto symmetric
CCT (K)	2700
CRI>	90

Electrical

Insulation class	III
Frequency (Hz)	50/60
Main voltage (Vac)	100-240/48
LED voltage Vf (Vdc)	null
LED current (mA)	700
Driver	Remote included
Dimmable	Yes
Dimming type	Electronic 48V
Dimming interface	Switch Integrated (Remote Dimmable)
Plug type	Type G, Type A, Type C
Batteries inside	No

Ecodesign and Energy Labelling

This product contains a light source of energy efficiency class **G**

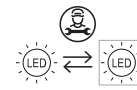

Replaceable (LED only)
light source by a
professional

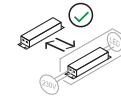

Replaceable control
gear by an end-user

Spare Parts

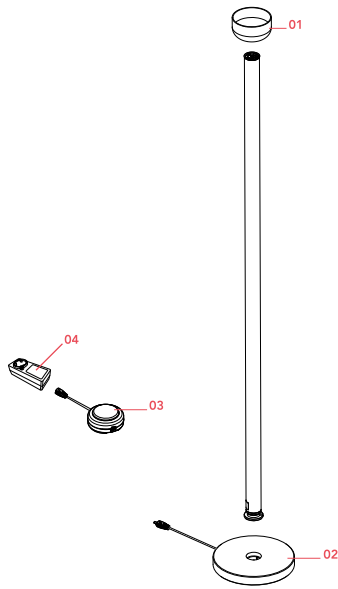

- | | | |
|-----|---|-----------|
| 01. | Bellhop F Reflector Grey | F1073020 |
| 02. | Bellhop F Base Concrete | F1072009 |
| 03. | Switch Dimmer Assembly
700mA | RF30216 |
| 04. | Black plug assembly kit & 48V
driver | RF3320400 |
| 10. | Assembly Coaxial Connector | RF3390130 |

DOWNLOAD



F1073020

Bellhop F Reflector Grey



F1072009

Bellhop F Base Concrete



RF30216

Switch Dimmer Assembly 700mA



RF3320400

Black plug assembly kit & 48V driver



RF3390130

Assembly Coaxial Connector

FLOS

F1070026 Cioko

Bellhop Floor

Designed by Edward Barber and Jay Osgerby, 2020

26W - 1023lm - 2700K - CRI> 90



Floor lamp with indirect light. Stem in painted aluminium: shiny white, brick, cioko, green. Reflector in shiny opal white and grey blown glass. Electrical cable of 270 cm usable length with foot dimmer switch for ON/OFF function and brightness adjustment 10–100%. Power supply with interchangeable plugs.

Are you a professional and your project needs consulting and support?

BOOK AN APPOINTMENT

Main specifications

EAN	8059607039700
Mounting	Floor
Environments	Indoor dry location
Light Source Type	LED
LED type	LED array
Power (W)	26
System power (W)	26
System flux (lm)	1023

Physical

Colour	Cioko
Length (mm)	260
Cord length (mm)	2700
Net weight (kg)	9.82
Package height (mm)	0
Package width (mm)	0
Package length (mm)	0
Package volume (m3)	0.05
IP internal	20

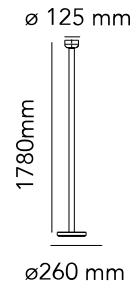

Download

- Mounting instructions [↓ PDF](#)
- Mounting instructions [↓ PDF](#)
- Spare Parts [↓ PDF](#)

Photometric Files

- LDT / IES [↓ LDT](#)

Technical Drawings

- 3D [↓ ZIP](#)
- Bim [↓ ZIP](#)



Schematic light drawing

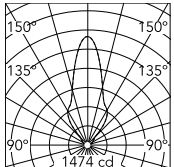

Beam Angle: 33°

h(m)	E(lx)	D(m)
1	1474	0.59
2	368	1.19
3	164	1.78
4	92	2.38
5	59	2.97

Luminous flux Luminaire
1232 lm

Photometric

Lighting type	Indirect
Light distribution	Roto symmetric
CCT (K)	2700
CRI>	90

Electrical

Insulation class	III
Frequency (Hz)	50/60
Main voltage (Vac)	100-240/48
LED voltage Vf (Vdc)	null
LED current (mA)	700
Driver	Remote included
Dimmable	Yes
Dimming type	Electronic 48V
Dimming interface	Switch Integrated (Remote Dimmable)
Plug type	Type G, Type A, Type C
Batteries inside	No

Ecodesign and Energy Labelling

This product contains a light source of energy efficiency class **G**

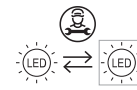

Replaceable (LED only)
light source by a
professional

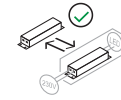

Replaceable control
gear by an end-user

Spare Parts

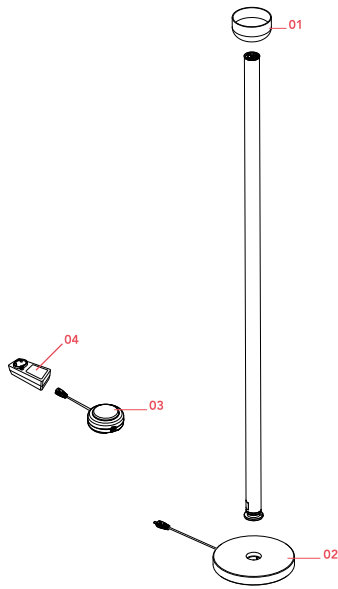

- | | | |
|-----|---|-----------|
| 01. | Bellhop F Reflector White | F1073009 |
| 02. | Bellhop F Base Concrete | F1072009 |
| 03. | Switch Dimmer Assembly
700mA | RF30216 |
| 04. | Black plug assembly kit & 48V
driver | RF3320400 |
| 10. | Assembly Coaxial Connector | RF3390130 |

DOWNLOAD



F1073009

Bellhop F Reflector White



F1072009

Bellhop F Base Concrete



RF30216

Switch Dimmer Assembly 700mA



RF3320400

Black plug assembly kit & 48V driver



RF3390130

Assembly Coaxial Connector

FLOS

F1070039 Green

Bellhop Floor

Designed by Edward Barber and Jay Osgerby, 2020

26W - 1023lm - 2700K - CRI> 90



Floor lamp with indirect light. Stem in painted aluminium: shiny white, brick, cioko, green. Reflector in shiny opal white and grey blown glass. Electrical cable of 270 cm usable length with foot dimmer switch for ON/OFF function and brightness adjustment 10-100%. Power supply with interchangeable plugs.

Are you a professional and your project needs consulting and support?

BOOK AN APPOINTMENT

Main specifications

EAN	8059607039724
Mounting	Floor
Environments	Indoor dry location
Light Source Type	LED
LED type	LED array
Power (W)	26
System power (W)	26
System flux (lm)	1023

Physical

Colour	Green
Length (mm)	260
Cord length (mm)	2700
Net weight (kg)	9.82
Package height (mm)	0
Package width (mm)	0
Package length (mm)	0
Package volume (m3)	0.05
IP internal	20

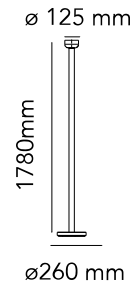

Download

Mounting instructions	↓ PDF
Mounting instructions	↓ PDF
Spare Parts	↓ PDF

Photometric Files

LDT / IES	↓ LDT
-----------	-------

Technical Drawings

3D	↓ ZIP
Bim	↓ ZIP



Schematic light drawing

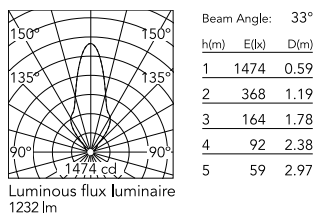

Photometric

Lighting type	Indirect
Light distribution	Roto symmetric
CCT (K)	2700
CRI>	90

Electrical

Insulation class	III
Frequency (Hz)	50/60
Main voltage (Vac)	100-240/48
LED voltage Vf (Vdc)	null
LED current (mA)	700
Driver	Remote included
Dimmable	Yes
Dimming type	Electronic 48V
Dimming interface	Switch Integrated (Remote Dimmable)
Plug type	Type G, Type A, Type C
Batteries inside	No

Ecodesign and Energy Labelling

This product contains a light source of energy efficiency class **G**

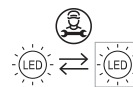

Replaceable (LED only) light source by a professional

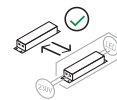

Replaceable control gear by an end-user

Spare Parts

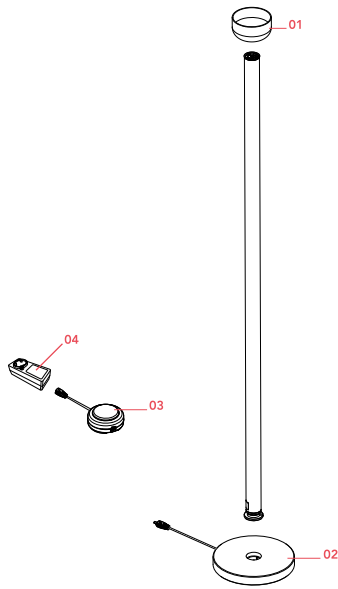

- | | | |
|-----|---|-----------|
| 01. | Bellhop F Reflector White | F1073009 |
| 02. | Bellhop F Base Concrete | F1072009 |
| 03. | Switch Dimmer Assembly
700mA | RF30216 |
| 04. | Black plug assembly kit & 48V
driver | RF3320400 |
| 10. | Assembly Coaxial Connector | RF3390130 |

DOWNLOAD



F1073009

Bellhop F Reflector White



F1072009

Bellhop F Base Concrete



RF30216

Switch Dimmer Assembly 700mA



RF3320400

Black plug assembly kit & 48V driver



RF3390130

Assembly Coaxial Connector

FLOS

 F1070075 Brick Red

Bellhop Floor

Designed by Edward Barber and Jay Osgerby, 2020

26W - 1023lm - 2700K - CRI> 90



Floor lamp with indirect light. Stem in painted aluminium: shiny white, brick, cioko, green. Reflector in shiny opal white and grey blown glass. Electrical cable of 270 cm usable length with foot dimmer switch for ON/OFF function and brightness adjustment 10–100%. Power supply with interchangeable plugs.

Are you a professional and your project needs consulting and support?

[BOOK AN APPOINTMENT](#)

Main specifications



EAN	8059607039717
Mounting	Floor
Environments	Indoor dry location
Light Source Type	LED
LED type	LED array
Power (W)	26
System power (W)	26
System flux (lm)	1023

Physical

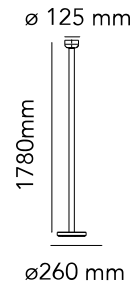
Colour	Brick Red
Length (mm)	260
Cord length (mm)	2700
Net weight (kg)	9.82
Package height (mm)	0
Package width (mm)	0
Package length (mm)	0
Package volume (m3)	0.05
IP internal	20



Download

- [Mounting instructions](#)  PDF
- [Mounting instructions](#)  PDF
- [Spare Parts](#)  PDF

Photometric Files

- [LDT / IES](#)  LDT

Technical Drawings

- [3D](#)  ZIP
- [Bim](#)  ZIP



Schematic light drawing

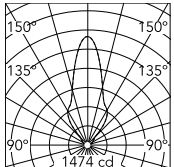

Beam Angle: 33°

h(m)	E(lx)	D(m)
1	1474	0.59
2	368	1.19
3	164	1.78
4	92	2.38
5	59	2.97

Luminous flux Luminaire
1232 lm

Photometric

Lighting type	Indirect
Light distribution	Roto symmetric
CCT (K)	2700
CRI>	90

Electrical

Insulation class	III
Frequency (Hz)	50/60
Main voltage (Vac)	100-240/48
LED voltage Vf (Vdc)	null
LED current (mA)	700
Driver	Remote included
Dimmable	Yes
Dimming type	Electronic 48V
Dimming interface	Switch Integrated (Remote Dimmable)
Plug type	Type G, Type A, Type C
Batteries inside	No

Ecodesign and Energy Labelling

This product contains a light source of energy efficiency class **G**

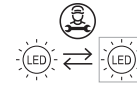

Replaceable (LED only)
light source by a
professional

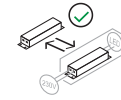

Replaceable control
gear by an end-user

Spare Parts

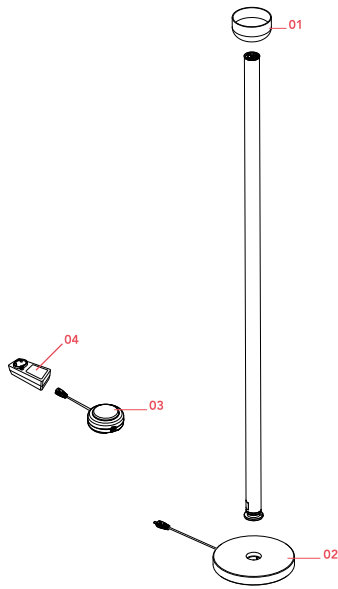

- | | | |
|-----|---|-----------|
| 01. | Bellhop F Reflector White | F1073009 |
| 02. | Bellhop F Base Concrete | F1072009 |
| 03. | Switch Dimmer Assembly
700mA | RF30216 |
| 04. | Black plug assembly kit & 48V
driver | RF3320400 |
| 10. | Assembly Coaxial Connector | RF3390130 |

DOWNLOAD



F1073009

Bellhop F Reflector White



F1072009

Bellhop F Base Concrete



RF30216

Switch Dimmer Assembly 700mA



RF3320400

Black plug assembly kit & 48V driver



RF3390130

Assembly Coaxial Connector