

FLOS

F1032015 Copper

Bon Jour

Designed by Philippe Starck, 2015



13W - 811lm - 2700K - CRI> 90

Table lamp providing diffuse light. Injection moulded PMMA clear transparent base and diffuser. Edge Lighting technology light source. Power cord length 200 cm, with dimmer switch that provide ON-OFF functions and 10-100% light adjustment. Plug-in power supply with interchangeable plugs.

Are you a professional and your project needs consulting and support?

BOOK AN APPOINTMENT

Main specifications

EAN	8059607001158
Mounting	Table
Environments	Indoor dry location
Light Source Type	LED
LED type	LED Module
Power (W)	13
System flux (lm)	811

Physical

Colour	Copper
Length (mm)	283
Cord length (mm)	2350
Net weight (kg)	1.65
Package height (mm)	0
Package width (mm)	0
Package length (mm)	0
Package volume (m3)	0.07
IP internal	20

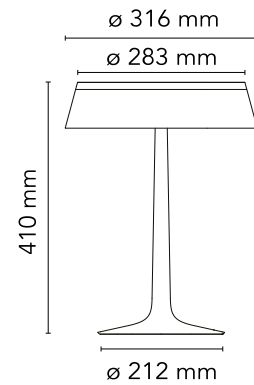

Download

Mounting instructions	↓ PDF
Mounting instructions	↓ PDF
Spare Parts	↓ PDF

Photometric Files

LDT / IES	↓ ZIP
-----------	-------

Technical Drawings

2D	↓ ZIP
3D	↓ ZIP



Schematic light drawing

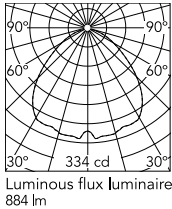

Photometric

Lighting type	Direct
Light distribution	Roto symmetric
CCT (K)	2700
CRI>	90

Electrical

Insulation class	III
Frequency (Hz)	50/60
Main voltage (Vac)	100-240/24
LED voltage Vf (Vdc)	null
Driver	Remote included
Dimmable	Yes
Dimming type	Electronic 24V
Dimming interface	Dimmer Integrated
Plug type	Type G, Type A, Type C
Batteries inside	No

Ecodesign and Energy Labelling

This product contains a light source of energy efficiency class E



Replaceable (LED only) light source by a professional



Replaceable control gear by an end-user

Accessories & Power Supply



OPTIONAL

F1033000

Bon Jour Crown



OPTIONAL

F1033007

Bon Jour Crown



OPTIONAL

F1033019

Bon Jour Crown



OPTIONAL

F1033030

Bon Jour Crown



OPTIONAL

F1033070

Bon Jour Crown



OPTIONAL

F1033088

Bon Jour Crown

Spare Parts

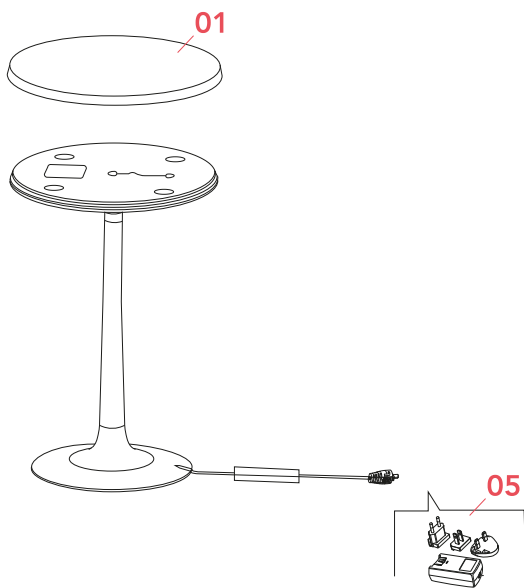

- | | | |
|-----|--------------------------------------|-----------|
| 01. | Top cover copper assembly | F1031015 |
| 05. | White plug assembly kit & 24V driver | RF3320200 |

DOWNLOAD



F1031015

Top cover copper assembly



RF3320200

White plug assembly kit & 24V driver

FLOS

F1032046 Matte Chrome

Bon Jour

Designed by Philippe Starck, 2015



13W - 811lm - 2700K - CRI> 90

Table lamp providing diffuse light. Injection moulded PMMA clear transparent base and diffuser. Edge Lighting technology light source. Power cord length 200 cm, with dimmer switch that provide ON-OFF functions and 10-100% light adjustment. Plug-in power supply with interchangeable plugs.

Are you a professional and your project needs consulting and support?

BOOK AN APPOINTMENT

Main specifications

EAN	8059607001165
Mounting	Table
Environments	Indoor dry location
Light Source Type	LED
LED type	LED Module
Power (W)	13
System flux (lm)	811

Physical

Colour	Matte Chrome
Length (mm)	283
Cord length (mm)	2350
Net weight (kg)	1.65
Package height (mm)	0
Package width (mm)	0
Package length (mm)	0
Package volume (m3)	0.07
IP internal	20

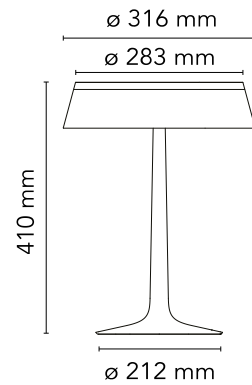

Download

Mounting instructions	↓ PDF
Mounting instructions	↓ PDF
Spare Parts	↓ PDF

Photometric Files

LDT / IES	↓ ZIP
-----------	-------

Technical Drawings

2D	↓ ZIP
3D	↓ ZIP



Schematic light drawing

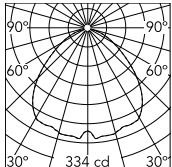

Photometric

Lighting type	Direct
Light distribution	Roto symmetric
CCT (K)	2700
CRI>	90

Electrical

Insulation class	III
Frequency (Hz)	50/60
Main voltage (Vac)	100-240/24
LED voltage Vf (Vdc)	null
Driver	Remote included
Dimmable	Yes
Dimming type	Electronic 24V
Dimming interface	Dimmer Integrated
Plug type	Type G, Type A, Type C
Batteries inside	No

Ecodesign and Energy Labelling

This product contains a light source of energy efficiency class E

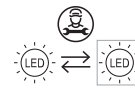

Replaceable (LED only) light source by a professional

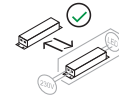

Replaceable control gear by an end-user

Accessories & Power Supply



OPTIONAL

F1033000

Bon Jour Crown



OPTIONAL

F1033007

Bon Jour Crown



OPTIONAL

F1033019

Bon Jour Crown



OPTIONAL

F1033030

Bon Jour Crown



OPTIONAL

F1033070

Bon Jour Crown



OPTIONAL

F1033088

Bon Jour Crown

Spare Parts

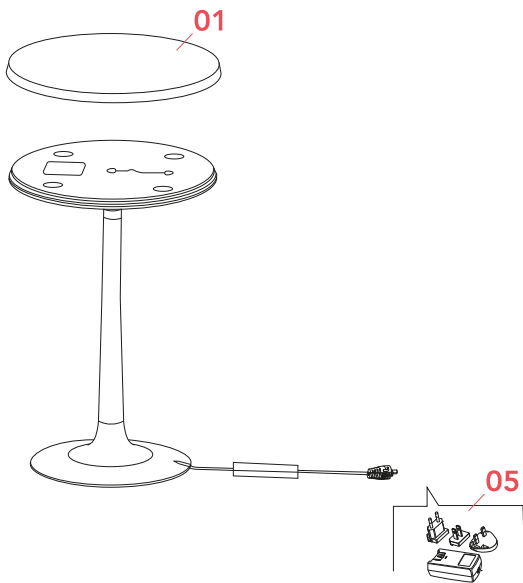

- | | | |
|-----|--------------------------------------|-----------|
| 01. | Top cover mat chrome assembly | F1031046 |
| 05. | White plug assembly kit & 24V driver | RF3320200 |

DOWNLOAD



F1031046

Top cover mat chrome assembly



RF3320200

White plug assembly kit & 24V driver

FLOS

F1037015 Copper

Bon Jour Unplugged

Designed by Philippe Starck, 2015



2.5W - 181lm - 2700K - CRI> 90

Cordless table lamp providing direct light. Painted or electroplated base and top cover in ABS. Injection moulded PMMA clear transparent diffuser and lampshade. Edge Lighting technology light source. 6/24 hours battery life, rechargeable with Micro-USB. Optical switch sensor on the base that provide 4-step dimming function. USB-C charger cable included in the package useful length 120 cm. Plug-in USB battery charger with interchangeable plugs.

Are you a professional and your project needs consulting and support?

[BOOK AN APPOINTMENT](#)

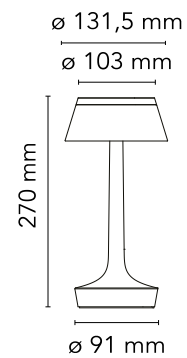

Main specifications

EAN	8059607014516
Mounting	Table
Environments	Indoor dry location
Light Source Type	LED
LED type	LED Module
Power (W)	2.5
System flux (lm)	181

Physical

Colour	Copper
Length (mm)	110
Net weight (kg)	0.55
Package height (mm)	170
Package width (mm)	230
Package length (mm)	375
Package volume (m3)	0.01
IP internal	20

Download

- [Mounting instructions](#)  PDF
- [Spare Parts](#)  PDF

Ecodesign and Energy Labelling

This product contains a light source of energy efficiency class F

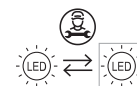

Replaceable (LED only) light source by a professional

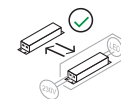

Replaceable control gear by an end-user



Schematic light drawing

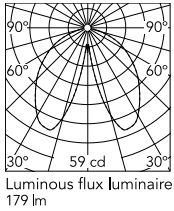

Photometric

Lighting type	Direct
Light distribution	Roto symmetric
CCT (K)	2700
CRI>	90

Electrical

Insulation class	III
Frequency (Hz)	50/60
Main voltage (Vac)	100-240/5
LED voltage Vf (Vdc)	null
Driver	Remote included
Dimmable	Yes
Dimming type	Electronic 5V
Dimming interface	Dimmer Integrated
Plug type	Type G, Type A, Type C
Batteries inside	Yes
Battery type	LI-PO
Charging max power	14
Charging min time	3H - 0% TO 100%
Charging socket/connector	USB-C

Accessories & Power Supply



OPTIONAL

F1036000

Bon Jour Unplugged Crown



OPTIONAL

F1036007

Bon Jour Unplugged Crown



OPTIONAL

F1036019

Bon Jour Unplugged Crown



OPTIONAL

F1036030

Bon Jour Unplugged Crown



OPTIONAL

F1036035

Bon Jour Unplugged Crown

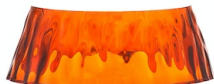

OPTIONAL

F1036070

Bon Jour Unplugged Crown



OPTIONAL

F1036088

Bon Jour Unplugged Crown

Spare Parts

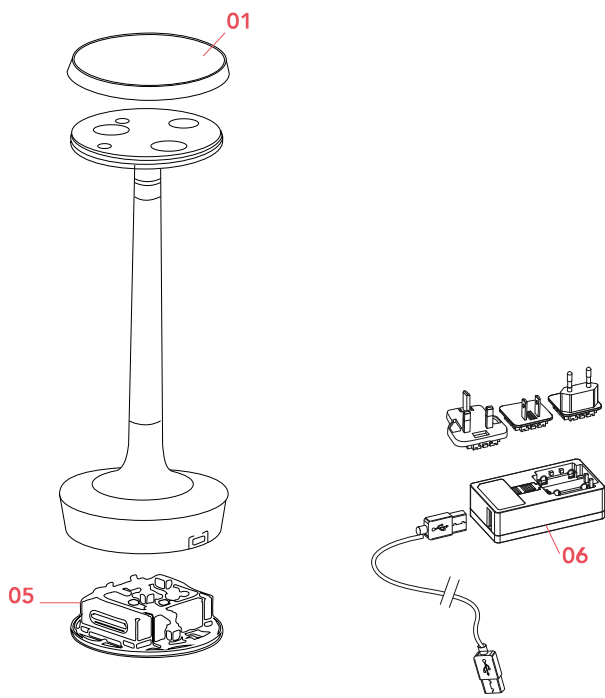

- | | | |
|-----|---|-----------|
| 01. | Top cover copper assembly | RF25461 |
| 05. | Base assembly with new battery kit | RF1037200 |
| 06. | Power charger with electrical cable & plugs | RF1035109 |

DOWNLOAD



RF25461

Top cover copper assembly

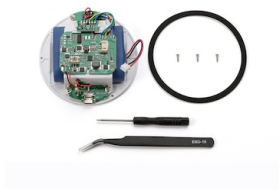

RF1037200

Base assembly with new battery kit



RF1035109

Power charger with electrical cable & plugs

FLOS

F1037009 White

Bon Jour Unplugged

Designed by Philippe Starck, 2015



2.5W - 181lm - 2700K - CRI> 90

Cordless table lamp providing direct light. Painted or electroplated base and top cover in ABS. Injection moulded PMMA clear transparent diffuser and lampshade. Edge Lighting technology light source. 6/24 hours battery life, rechargeable with Micro-USB. Optical switch sensor on the base that provide 4-step dimming function. USB-C charger cable included in the package useful length 120 cm. Plug-in USB battery charger with interchangeable plugs.

Are you a professional and your project needs consulting and support?

[BOOK AN APPOINTMENT](#)

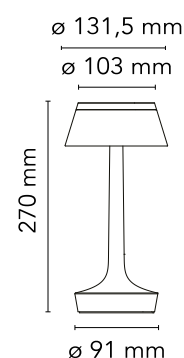

Main specifications

EAN	8059607014509
Mounting	Table
Environments	Indoor dry location
Light Source Type	LED
LED type	LED Module
Power (W)	2.5
System flux (lm)	181

Physical

Colour	White
Length (mm)	110
Net weight (kg)	0.55
Package height (mm)	170
Package width (mm)	230
Package length (mm)	375
Package volume (m3)	0.01
IP internal	20

Download

[Mounting instructions](#)  PDF
[Spare Parts](#)  PDF

Ecodesign and Energy Labelling

This product contains a light source of energy efficiency class F



Replaceable (LED only) light source by a professional

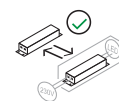

Replaceable control gear by an end-user



Schematic light drawing

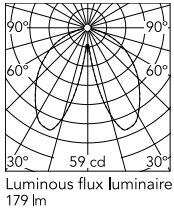

Photometric

Lighting type	Direct
Light distribution	Roto symmetric
CCT (K)	2700
CRI>	90

Electrical

Insulation class	III
Frequency (Hz)	50/60
Main voltage (Vac)	100-240/5
LED voltage Vf (Vdc)	null
Driver	Remote included
Dimmable	Yes
Dimming type	Electronic 5V
Dimming interface	Dimmer Integrated
Plug type	Type G, Type A, Type C
Batteries inside	Yes
Battery type	LI-PO
Charging max power	14
Charging min time	3H - 0% TO 100%
Charging socket/connector	USB-C

Accessories & Power Supply



OPTIONAL

F1036000

Bon Jour Unplugged Crown



OPTIONAL

F1036007

Bon Jour Unplugged Crown



OPTIONAL

F1036019

Bon Jour Unplugged Crown



OPTIONAL

F1036030

Bon Jour Unplugged Crown



OPTIONAL

F1036035

Bon Jour Unplugged Crown



OPTIONAL

F1036070

Bon Jour Unplugged Crown



OPTIONAL

F1036088

Bon Jour Unplugged Crown

Spare Parts

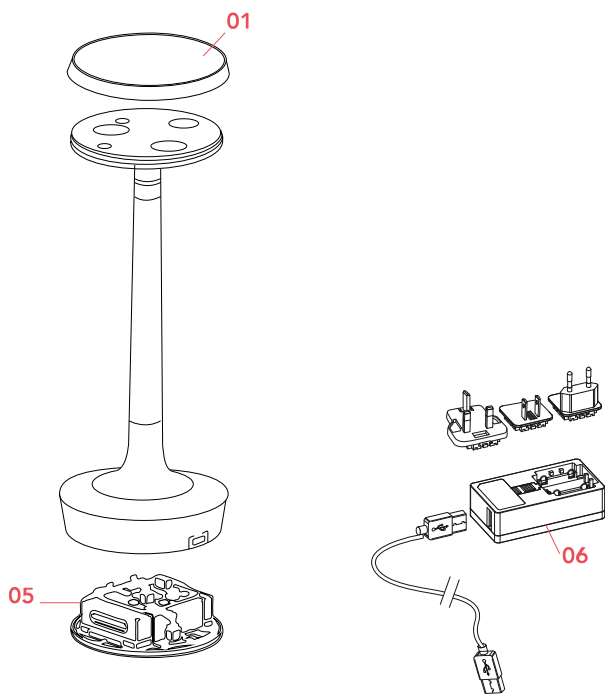

- | | | |
|-----|---|-----------|
| 01. | Top cover white assembly | RF25453 |
| 05. | Base assembly with new battery kit | RF1037200 |
| 06. | Power charger with electrical cable & plugs | RF1035109 |

DOWNLOAD



RF25453

Top cover white assembly

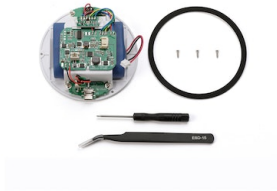

RF1037200

Base assembly with new battery kit



RF1035109

Power charger with electrical cable & plugs

FLOS

F1041015 Copper

Bon Jour Versailles

Designed by Philippe Starck, 2017

13W - 854lm - 2700K - CRI> 90



Table lamp providing diffuse light. Injection molded polymethylmethacrylate clear transparent base and diffuser. Electroplated/painted top cover in ABS. Edge Lighting technology light source. Power cord length 200 cm, with dimmer switch that provide ON-OFF functions and 10-100 % light adjustment. Plug-in power supply with interchangeable plugs.

Are you a professional and your project needs consulting and support?

BOOK AN APPOINTMENT

Main specifications

EAN	8059607014660
Mounting	Table
Environments	Indoor dry location
Light Source Type	LED
LED type	LED Module
Power (W)	13
System flux (lm)	854

Physical

Colour	Copper
Length (mm)	316
Cord length (mm)	2350
Net weight (kg)	1.7
Package height (mm)	375
Package width (mm)	380
Package length (mm)	530
Package volume (m3)	0.08
IP internal	20

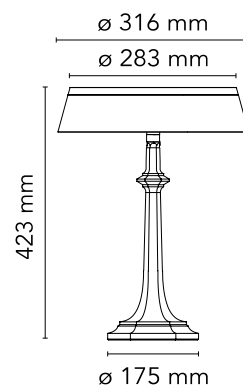

Download

- Mounting instructions PDF
- Mounting instructions PDF
- Spare Parts PDF

Ecodesign and Energy Labelling

This product contains a light source of energy efficiency class E

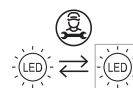

Replaceable (LED only) light source by a professional

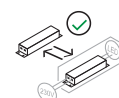

Replaceable control gear by an end-user



Schematic light drawing

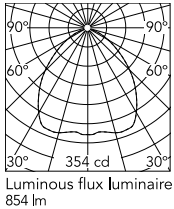

Photometric

Lighting type	Direct
Light distribution	Roto symmetric
CCT (K)	2700
CRI>	90

Electrical

Insulation class	III
Frequency (Hz)	50/60
Main voltage (Vac)	100-240/24
LED voltage Vf (Vdc)	null
Driver	Remote included
Dimmable	Yes
Dimming type	Electronic 24V
Dimming interface	Dimmer Integrated
Plug type	Type G, Type A, Type C
Batteries inside	No

Accessories & Power Supply



OPTIONAL

F1033000

Bon Jour Crown



OPTIONAL

F1033007

Bon Jour Crown



OPTIONAL

F1033019

Bon Jour Crown



OPTIONAL

F1033030

Bon Jour Crown



OPTIONAL

F1033070

Bon Jour Crown



OPTIONAL

F1033088

Bon Jour Crown

Spare Parts

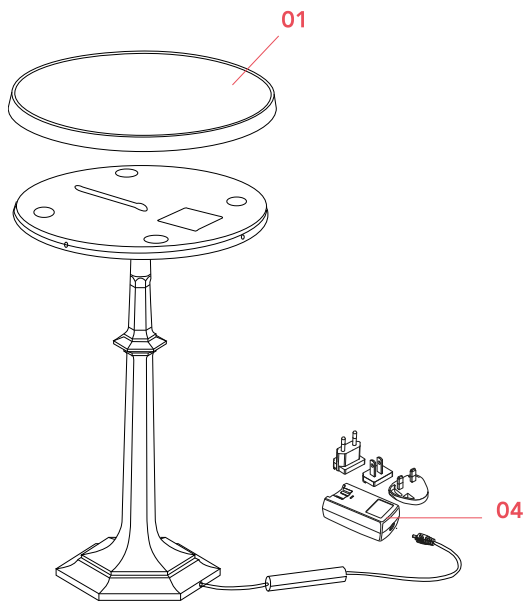

- | | | |
|-----|--------------------------------------|-----------|
| 00. | Top cover copper assembly | F1031015 |
| 04. | White plug assembly kit & 24V driver | RF3320200 |

DOWNLOAD



F1031015

Top cover copper assembly



RF3320200

White plug assembly kit & 24V
driver

FLOS

F1042057 Chrome

Bon Jour Versailles Small

Designed by Philippe Starck, 2017

3.5W - 208lm - 2700K - CRI> 90



Table lamp providing diffuse light. Injection molded polymethylmethacrylate clear transparent base and diffuser. Electroplated/painted top cover in ABS. Edge Lighting technology light source. Power cord length 200 cm, with dimmer switch that provide ON-OFF functions and 10-100 % light adjustment. Plug-in power supply with interchangeable plugs.

Are you a professional and your project needs consulting and support?

BOOK AN APPOINTMENT

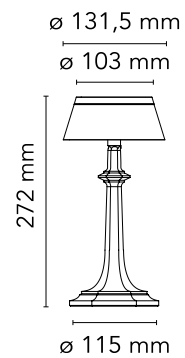

Main specifications

EAN	8059607014714
Mounting	Table
Environments	Indoor dry location
Light Source Type	LED
LED type	LED Module
Power (W)	3.5
System flux (lm)	208

Physical

Colour	Chrome
Length (mm)	132
Cord length (mm)	2150
Net weight (kg)	0.5
Package height (mm)	175
Package width (mm)	270
Package length (mm)	400
Package volume (m3)	0.02
IP internal	20

Download

Mounting instructions	↓ PDF
Mounting instructions	↓ PDF
Spare Parts	↓ PDF

Ecodesign and Energy Labelling

This product contains a light source of energy efficiency class F

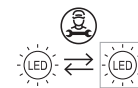

Replaceable (LED only) light source by a professional

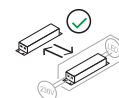

Replaceable control gear by an end-user



Schematic light drawing

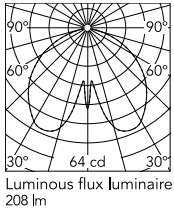

Photometric

Lighting type	Direct
Light distribution	Roto symmetric
CCT (K)	2700
CRI>	90

Electrical

Insulation class	III
Frequency (Hz)	50/60
Main voltage (Vac)	100-240/24
LED voltage Vf (Vdc)	null
Driver	Remote included
Dimmable	Yes
Dimming type	Electronic 24V
Dimming interface	Dimmer Integrated
Plug type	Type G, Type A, Type C
Batteries inside	No

Accessories & Power Supply



OPTIONAL

F1036000

Bon Jour Unplugged Crown



OPTIONAL

F1036007

Bon Jour Unplugged Crown



OPTIONAL

F1036019

Bon Jour Unplugged Crown



OPTIONAL

F1036030

Bon Jour Unplugged Crown



OPTIONAL

F1036035

Bon Jour Unplugged Crown

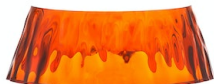

OPTIONAL

F1036070

Bon Jour Unplugged Crown



OPTIONAL

F1036088

Bon Jour Unplugged Crown

Spare Parts

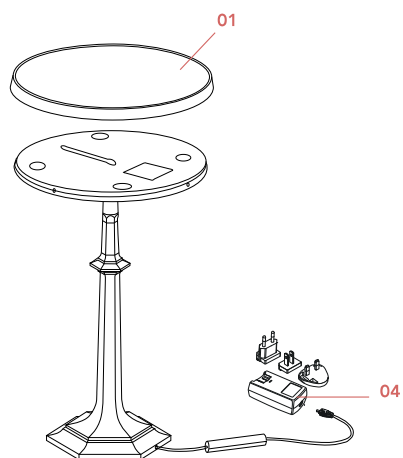

- | | | |
|-----|--------------------------------------|-----------|
| 01. | Top cover chrome assembly | RF25460 |
| 04. | White plug assembly kit & 24V driver | RF3320200 |

DOWNLOAD



RF25460

Top cover chrome assembly



RF3320200

White plug assembly kit & 24V driver