

FLOS

F3190009 White

Button HL

Designed by Piero Lissoni, 2004



Halogen - 5 x 40W

Wall/ceiling fixture providing diffused lighting for indoor use. Hand-blown opal ply glass diffuser (transparent □ opal □ transparent) with acid finish. Sheared, deep-drawn steel sheet wall/ceiling attachment with white galvanized finish. Sheared, deep-drawn steel sheet reflector painted white for high temperatures. Closing cover in injection molded tecnopolymer with chrome finish. Satin-finish incandescent line voltage halogen lamps.

Are you a professional and your project needs consulting and support?

BOOK AN APPOINTMENT

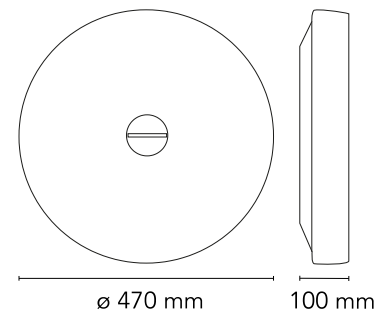

Main specifications

EAN	8059607018866
Mounting	Ceiling and wall surface
Environments	Indoor dry location
Light Source Type	Bulb
Lamp category	Halogen
Lamp holders	G9
Iicos	HSGS
Number of heads	5
Power (W)	40

Physical

Colour	White
Length (mm)	470
Net weight (kg)	7
Package height (mm)	175
Package width (mm)	555
Package length (mm)	555
Package volume (m3)	0.05
IP internal	40

Download

Mounting instructions [↓ PDF](#)

Spare Parts [↓ PDF](#)

Photometric Files

LDT / IES [↓ ZIP](#)

Technical Drawings

2D [↓ ZIP](#)

3D [↓ ZIP](#)



Schematic light drawing

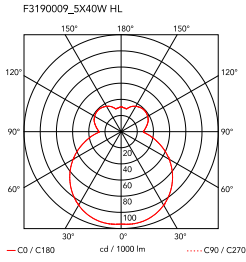

Photometric

Lighting type	Total
Light distribution	Roto symmetric

Electrical

Insulation class	I
Frequency (Hz)	50/60
Main voltage (Vac)	220-250
LED voltage Vf (Vdc)	null
Dimmable	Yes
Dimming interface	Remote Dimmable (Dimmer Not Included)
Batteries inside	No

Bulbs



NOT INCLUDED

RF26520

LED Lamp 2W 240lm G9 220-
240 2700K T13 Non Dimmable



NOT INCLUDED

RF28425

LED BiPin Lamp G9 3W 2700K
Non Dimmable

Spare Parts

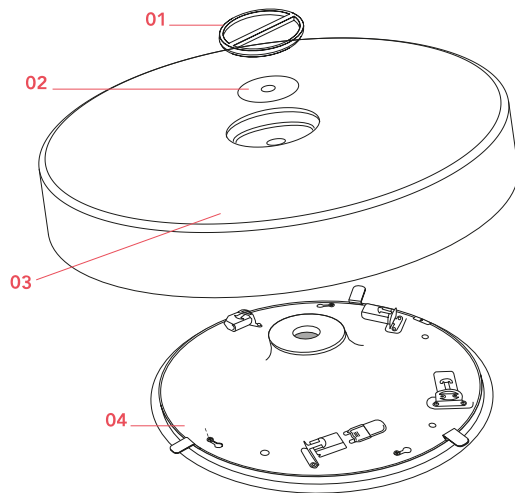

- | | | |
|-----|----------------------------------------------------------------------------------------|-----------|
| 01. | Chrome locking cap assembly | RF3190100 |
| 02. | Silicone Seal Shore Transparent
62x13x1,5 | RF15719 |
| 03. | non c'e - BUTTON HL (PER
VECCHIA VERSIONE NON
COMPATIBILE CON QUELLE
ATTUALI) | RF3190200 |
| 03. | Opal glass diffuser for new
version | RF3190300 |
| 04. | G9 Lamp Holder | RF15709 |

DOWNLOAD



RF3190100

Chrome locking cap assembly



RF15719

Silicone Seal Shore Transparent
62x13x1,5



RF3190200

non c'e - BUTTON HL (PER
VECCHIA VERSIONE NON
COMPATIBILE CON QUELLE
ATTUALI)



RF3190300

Opal glass diffuser for new
version



RF15709

G9 Lamp Holder

FLOS

F3180009 White

Button

Designed by Piero Lissoni, 2004



Fluorescent - 2 x 22+40W

Indoor and outdoor wall/ceiling lamp providing diffused light. Slightly opaline (PC opal), injection-molded polycarbonate diffuser. Closure screw/diffuser support in die-cast and handpolished aluminum alloy protected with liquid transparent paint. The wall attachment is slightly, injection-molded polycarbonate. The light bulb support is 30% glass fiberreinforced nylon, injection molded and matte white. Silicone elastomer dust and waterproof seals.

Are you a professional and your project needs consulting and support?

BOOK AN APPOINTMENT

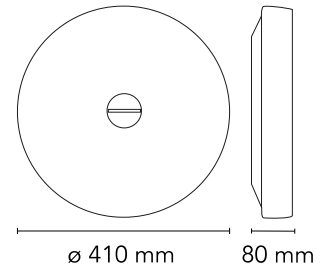

Main specifications

EAN	8059607018859
Mounting	Ceiling and wall surface
Environments	Indoor dry location
Light Source Type	Bulb
Lamp category	Fluorescent
Lamp holders	2GX13
Ilcos	FSC
Number of heads	2
Power (W)	22+40

Physical

Colour	White
Length (mm)	410
Net weight (kg)	2.15
Package height (mm)	100
Package width (mm)	420
Package length (mm)	430
Package volume (m3)	0.02
IP internal	44

Download

Mounting instructions [↓ PDF](#)

Spare Parts [↓ PDF](#)

Photometric Files

LDT / IES [↓ ZIP](#)

Technical Drawings

2D [↓ ZIP](#)

3D [↓ ZIP](#)



Schematic light drawing

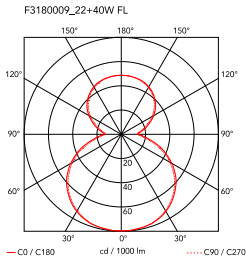

Photometric

Lighting type	Total
Light distribution	Roto symmetric

Electrical

Insulation class	II
Frequency (Hz)	50/60
Main voltage (Vac)	220-240
LED voltage Vf (Vdc)	null
Driver	Integrated
Dimmable	No
Dimming type	Non Dimmable
Dimming interface	Not Dimmable
Batteries inside	No

Bulbs

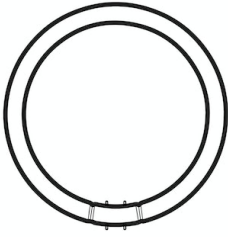

NOT INCLUDED

RF11177

Circular Fluorescent Lamp 2GX13
22W 3000K T5 Dimmable

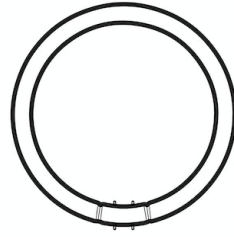

NOT INCLUDED

RF11178

Circular Fluorescent Lamp 2GX13
40W 3000K T6 Dimmable

Spare Parts

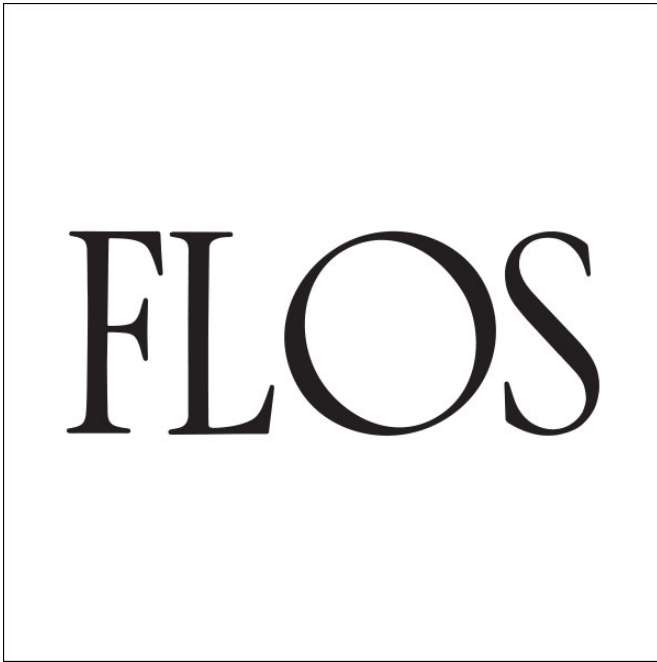

- | | | |
|-----|-----------------------------|-----------|
| 01. | Chrome locking cap assembly | RF3180100 |
| 02. | non c'è - BUTTON FL | RF20194 |
| 03. | Lamp holder | RF10722 |
| 04. | non c'è - BUTTON FL | RF21737 |
| 05. | non c'è - BUTTON FL | RF3180300 |

DOWNLOAD



RF3180100

Chrome locking cap assembly



RF20194

non c'è - BUTTON FL



RF10722

Lamp holder



RF21737

non c'è - BUTTON FL

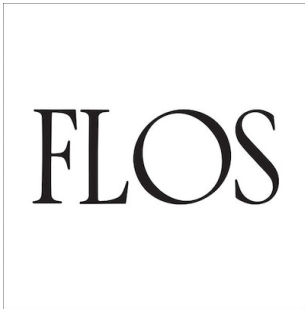

RF3180300

non c'e - BUTTON FL

FLOS

F1490009 Glass

Mini Button

Designed by Piero Lissoni, 2005



Halogen - 25W

Wall or ceiling fixture providing diffused lighting suitable for indoor and outdoor use. Silicone elastomer dust and waterproof seal. Die-cast aluminum lamp body and wall fitting. Diffuser available in opaline glass (IP40) or polycarbonate (IP44).

Are you a professional and your project needs consulting and support?

BOOK AN APPOINTMENT

Main specifications

EAN	8059607015179
Mounting	Ceiling and wall surface
Environments	Indoor Outdoor wet location
Light Source Type	Bulb
Lamp category	Halogen
Lamp holders	G9
Iicos	HSGS
Number of heads	1
Power (W)	25

Physical

Colour	Glass
Length (mm)	140
Net weight (kg)	0.66
Package height (mm)	70
Package width (mm)	190
Package length (mm)	205
IP internal	44

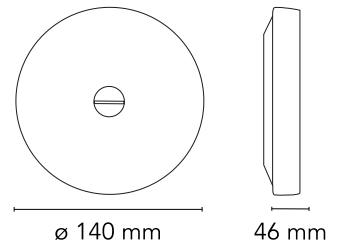

Download

Mounting instructions [↓ PDF](#)
Spare Parts [↓ PDF](#)



Schematic light drawing

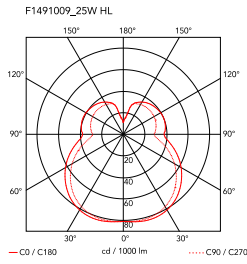

Photometric

Lighting type	Total
Light distribution	Roto symmetric

Electrical

Insulation class	I
Frequency (Hz)	50/60
Main voltage (Vac)	220-250
LED voltage Vf (Vdc)	null
Dimmable	Yes
Dimming interface	Remote Dimmable (Dimmer Not Included)
Batteries inside	No

Bulbs



NOT INCLUDED

RF26520

LED Lamp 2W 240lm G9 220-
240 2700K T13 Non Dimmable



NOT INCLUDED

RF28425

LED BiPin Lamp G9 3W 2700K
Non Dimmable

Spare Parts

- | | | |
|-----|-------------------------|-----------|
| 01. | G9 5600 lamp holder | RF12818 |
| 02. | Glass diffuser assembly | RF1490109 |

DOWNLOAD

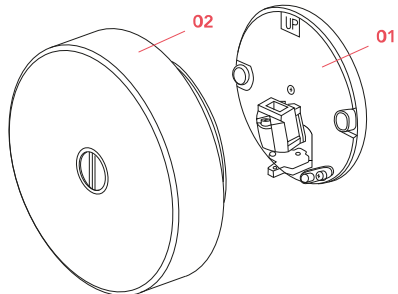



RF12818

G9 5600 lamp holder



RF1490109

Glass diffuser assembly

FLOS

F1491009 Polycarbonate

Mini Button

Designed by Piero Lissoni, 2005



Halogen - 25W

Wall or ceiling fixture providing diffused lighting suitable for indoor and outdoor use. Silicone elastomer dust and waterproof seal. Die-cast aluminum lamp body and wall fitting. Diffuser available in opaline glass (IP40) or polycarbonate (IP44).

Are you a professional and your project needs consulting and support?

[BOOK AN APPOINTMENT](#)

Main specifications

EAN	8059607015209
Mounting	Ceiling and wall surface
Environments	Indoor Outdoor wet location
Light Source Type	Bulb
Lamp category	Halogen
Lamp holders	G9
Iicos	HSGS
Number of heads	1
Power (W)	25

Physical

Colour	Polycarbonate
Length (mm)	140
Net weight (kg)	0.32
Package height (mm)	70
Package width (mm)	190
Package length (mm)	205
IP internal	44

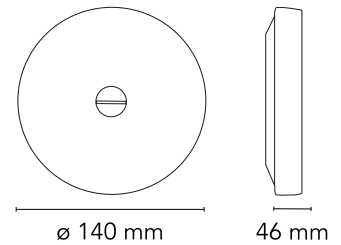

Download

[Mounting instructions](#)  PDF

[Spare Parts](#)  PDF

Photometric Files

[LDT / IES](#)  LDT



Schematic light drawing

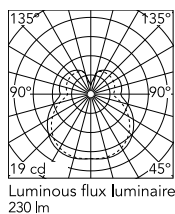

Beam Angle: 164°

h(m)	E(lx)	D(m)
1	19	14.44
2	5	28.88
3	2	43.32
4	1	57.76
5	1	72.20

Luminous flux Luminaire
230 lm

Photometric

Lighting type	Total
Light distribution	Roto symmetric

Electrical

Insulation class	I
Frequency (Hz)	50/60
Main voltage (Vac)	220-250
LED voltage Vf (Vdc)	null
Dimmable	Yes
Dimming interface	Remote Dimmable (Dimmer Not Included)
Batteries inside	No

Bulbs

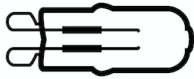

NOT INCLUDED

RF26520

LED Lamp 2W 240lm G9 220-
240 2700K T13 Non Dimmable



NOT INCLUDED

RF28425

LED BiPin Lamp G9 3W 2700K
Non Dimmable

Spare Parts

- | | | |
|-----|------------------------------------|-----------|
| 01. | G9 5600 lamp holder | RF12818 |
| 02. | Polybarbonate diffuser
assembly | RF1491109 |

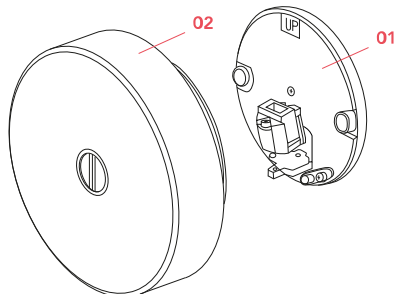

DOWNLOAD



RF12818

G9 5600 lamp holder



RF1491109

Polycarbonate diffuser
assembly