

FLOS

F3010061 White

Glo-Ball Suspension 2

Designed by Jasper Morrison, 1998



Halogen - 150W

Suspension lamp providing diffused light. Diffuser consisting of an externally acid-etched, hand blown, flashed opaline glass. Transparent, injection molded polycarbonate diffuser support. 30% fiberglass reinforced injection-molded polyamide rose; pressed and galvanized ceiling fitting. Steel suspension cable.

Are you a professional and your project needs consulting and support?

[BOOK AN APPOINTMENT](#)

Main specifications

EAN	8059607002223
Mounting	Suspension
Environments	Indoor dry location
Light Source Type	Bulb
Lamp category	Halogen
Lamp holders	E27
Ilcos	HSGS
Number of heads	1
Power (W)	150

Physical

Colour	White
Length (mm)	450
Cord length (mm)	2700
Net weight (kg)	3.77
Package height (mm)	0
Package width (mm)	0
Package length (mm)	0
Package volume (m3)	0.13
IP internal	20

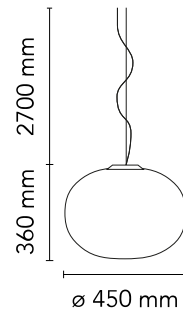

Download

[Mounting instructions](#) PDF

[Spare Parts](#) PDF

Photometric Files

[LDT / IES](#) LDT

Technical Drawings

[2D](#) ZIP

[3D](#) ZIP

[Bim](#) ZIP



Schematic light drawing

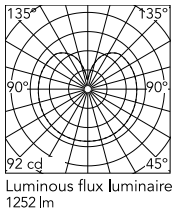

Photometric

Lighting type	Total
Light distribution	Roto symmetric

Electrical

Insulation class	I
Frequency (Hz)	50/60
Main voltage (Vac)	220-250
LED voltage Vf (Vdc)	null
Dimmable	Yes
Dimming interface	Remote Dimmable (Dimmer Not Included)
Batteries inside	No

Bulbs



NOT INCLUDED

RF26259

LED Lamp 18W E27 2700K
Dimmable



NOT INCLUDED

RF26258

LED Lamp 18W E27 3000K T38
Dimmable



NOT INCLUDED

RF32288

LED Lamp E27 15W 2700K T38



NOT INCLUDED

RF32289

LED Lamp E27 15W 3000K T38

Spare Parts

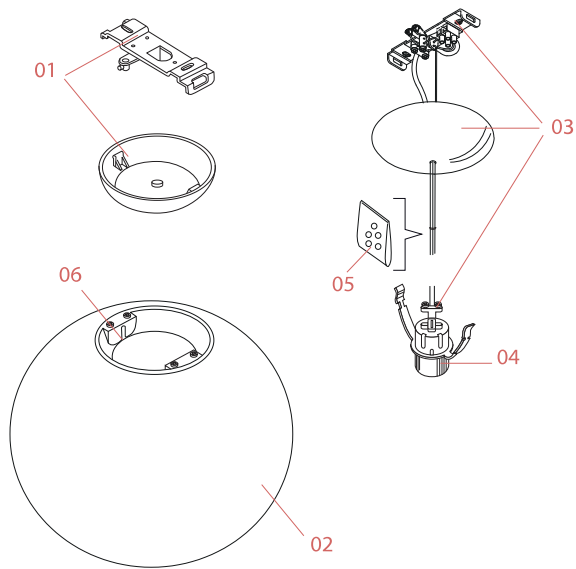

01.	White rose assembly	RA3690209
02.	Glo-Ball 2 white diffuser	F3015061
03.	Glo-Ball electrical wiring assembly	A2512000
04.	Bjb e27 lamp holder	RF04322
05.	Kit of 5 or rings	RF05382
06.	Ring nut assembly for diffuser 2	RF09514

DOWNLOAD



RA3690209

White rose assembly



F3015061

Glo-Ball 2 white diffuser



A2512000

Glo-Ball electrical wiring assembly



RF04322

Bjb e27 lamp holder



RF05382

Kit of 5 rings



RF09514

Ring nut assembly for diffuser 2

FLOS

F4195009 White

Mini Glo-Ball Suspension

Designed by Jasper Morrison, 2006



Halogen - 25W

Suspension lamp providing diffused light. Diffuser consisting of an externally acidetched, hand blown, flashed opaline glass. White painted, injection-molded PPS lamp-holder support.

Are you a professional and your project needs consulting and support?

[BOOK AN APPOINTMENT](#)

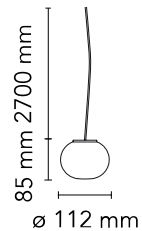

Main specifications

EAN	8059607020074
Mounting	Suspension
Environments	Indoor dry location
Light Source Type	Bulb
Lamp category	Halogen
Lamp holders	G9
Ilcos	HSGS
Number of heads	1
Power (W)	25

Physical

Colour	White
Length (mm)	120
Cord length (mm)	2700
Net weight (kg)	0.67
Package height (mm)	190
Package width (mm)	190
Package length (mm)	190
Package volume (m3)	0.01
IP internal	20

Download

[Mounting instructions](#)  PDF

[Spare Parts](#)  PDF

Photometric Files

[LDT / IES](#)  LDT

Technical Drawings

[2D](#)  ZIP

[3D](#)  ZIP

[Bim](#)  ZIP



Schematic light drawing

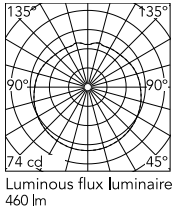

Photometric

Lighting type	Total
Light distribution	Roto symmetric

Electrical

Insulation class	II
Frequency (Hz)	50/60
Main voltage (Vac)	220-250
LED voltage Vf (Vdc)	null
Dimmable	Yes
Dimming interface	Remote Dimmable (Dimmer Not Included)
Batteries inside	No

Bulbs



NOT INCLUDED

RF26520

LED Lamp 2W 240lm G9 220-240 2700K T13 Non Dimmable



NOT INCLUDED

RF28425

LED BiPin Lamp G9 3W 2700K Non Dimmable

Spare Parts

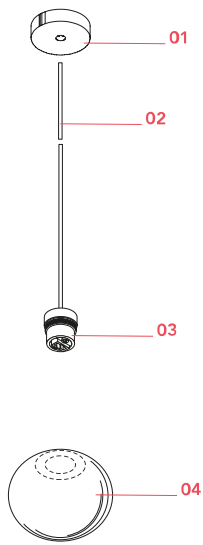

- | | | |
|-----|--|-----------|
| 01. | S1 ceiling rose assembly | RF6256001 |
| 02. | 5 meter sil/fep 2x0,75
transparent electrical cable | RF4190200 |
| 03. | G9 5600 lamp holder | RF12818 |
| 04. | Mini Glo-Ball Suspension new
diffuser assembly | RF4195200 |

DOWNLOAD



RF6256001
S1 ceiling rose assembly



RF4190200
5 meter sil/fep 2x0,75
transparent electrical cable



RF12818
G9 5600 lamp holder



RF4195200
Mini Glo-Ball Suspension new
diffuser assembly