

FLOS

F6303046 Aluminized Bronze

KTribe Table 2

Designed by Philippe Starck, 2007



Halogen - 150W

Table luminaire providing diffused lighting. Base, rod support and diffuser support in diecast, polished and chrome-plated Zamak alloy. Base cover in black injection-molded PA (Nylon). Injection-molded PC (polycarbonate) opal inner diffuser. Outer diffusers in transparent or fumée PMMA (polymethylmethacrylate), and silver or bronze on the inner surface, by vacuum aluminum coating. Injection-molded PC (polycarbonate) upper ring, completely transparent or transparent diffuser and silver diffuser) or transparent brown for the outer bronze diffuser.

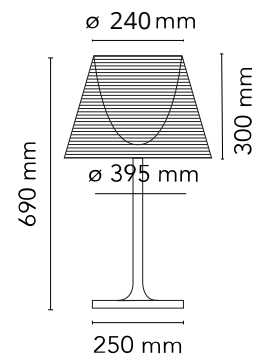

Are you a professional and your project needs consulting and support?

[BOOK AN APPOINTMENT](#)

Main specifications

Mounting	Table
Environments	Indoor dry location
Light Source Type	Bulb
Lamp category	Halogen
Lamp holders	E27
Iicos	HSGS
Number of heads	1
Power (W)	150

Physical

Colour	Aluminized Bronze
Length (mm)	395
Cord length (mm)	1640
Net weight (kg)	4.5
Package height (mm)	0
Package width (mm)	0
Package length (mm)	0
Package volume (m3)	0.18
IP internal	20

Download

[Mounting instructions](#) PDF

[Spare Parts](#) PDF

Photometric Files

[LDT / IES](#) LDT

Technical Drawings

[2D](#) ZIP

[3D](#) ZIP



Schematic light drawing

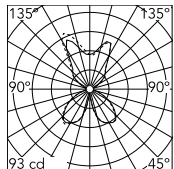

Luminous flux Luminaire
2400 lm

Photometric

Lighting type	Indirect, Direct
Light distribution	Symmetric

Electrical

Insulation class	II
Frequency (Hz)	50/60
Main voltage (Vac)	220-240
LED voltage Vf (Vdc)	null
Dimmable	Yes
Dimming interface	Dimmer Integrated
Plug type	Type C
Batteries inside	No

Bulbs

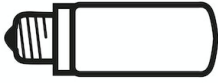

NOT INCLUDED

RF32288

LED Lamp E27 15W 2700K T38

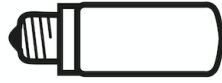

NOT INCLUDED

RF32289

LED Lamp E27 15W 3000K T38

Spare Parts

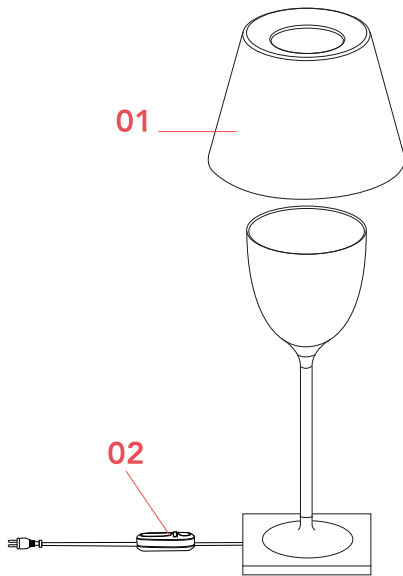

- | | | |
|-----|--|----------|
| 01. | Ktribe Floor/Table 2 aluminized bronze diffuser assembly | F6278046 |
| 02. | Dimmer 4-25W 220-240V Black | RF32262 |

DOWNLOAD



F6278046

Ktribe Floor/Table 2 aluminized
bronze diffuser assembly



RF32262

Dimmer 4-25W 220-240V Black

FLOS

F6281000 Transparent

KTribe Table 1 Glass

Designed by Philippe Starck, 2007

Halogen - 100W



Table luminaire providing diffused lighting. Base, rod support and diffuser support in die-cast, polished Zamak alloy. Polished aluminum tubular. Injection-molded, matte black PA (Nylon) base cover. Injection-molded PC (polycarbonate) opal inner diffuser. Outer diffuser in transparent glass

Are you a professional and your project needs consulting and support?

[BOOK AN APPOINTMENT](#)

Main specifications

Mounting	Table
Environments	Indoor dry location
Light Source Type	Bulb
Lamp category	Halogen
Lamp holders	E27
Iicos	HSGS
Number of heads	1
Power (W)	100

Physical

Colour	Transparent
Length (mm)	315
Cord length (mm)	1640
Net weight (kg)	4.58
Package height (mm)	0
Package width (mm)	0
Package length (mm)	0
Package volume (m3)	0.12
IP internal	20

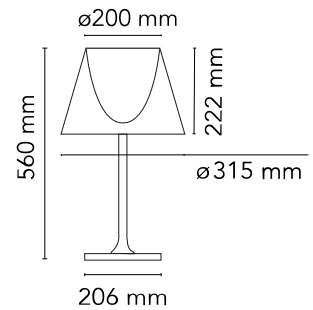

Download

[Mounting instructions](#) PDF

[Spare Parts](#) PDF

Photometric Files

[LDT / IES](#) LDT

Technical Drawings

[2D](#) ZIP

[3D](#) ZIP



Schematic light drawing

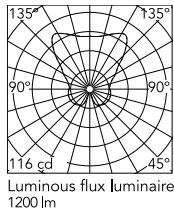

Photometric

Lighting type	Indirect, Direct
Light distribution	Symmetric

Electrical

Insulation class	II
Frequency (Hz)	50/60
Main voltage (Vac)	220-240
LED voltage Vf (Vdc)	null
Dimmable	Yes
Dimming interface	Dimmer Integrated
Plug type	Type C
Batteries inside	No

Bulbs

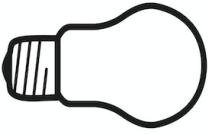

NOT INCLUDED

RF32563

LED Lamp 11.5W E27 220-240V
2700K A70



NOT INCLUDED

RF32564

LED Lamp 11.5W E27 220-240V
3000K A70

Spare Parts

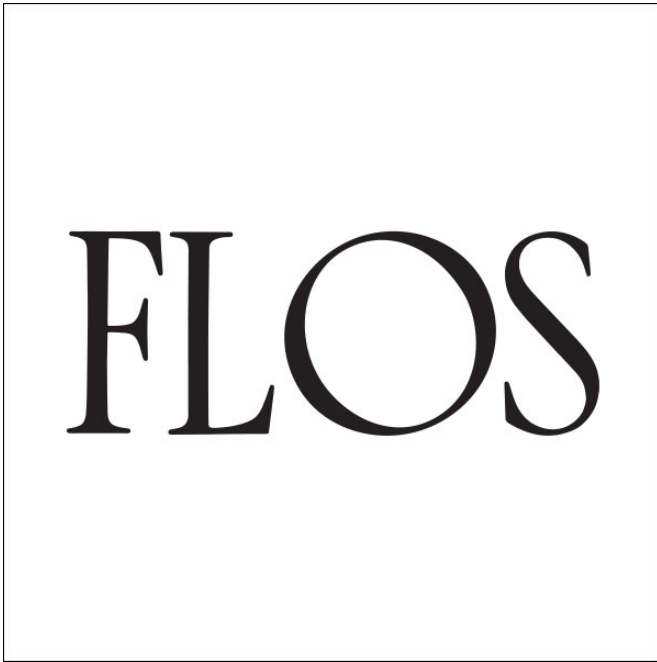

- 01. Ktribe Table 1 transparent diffuser assembly F6284000
- 02. Dimmer 4-25W 220-240V Black RF32262

DOWNLOAD



F6284000
Ktribe Table 1 transparent
diffuser assembly



RF32262
Dimmer 4-25W 220-240V Black