

# FLOS

■ F5921030 Black

## Ray Floor 2

Designed by Rodolfo Dordoni, 2006

Halogen - 250W

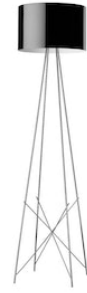

Floor lamp providing diffused lighting. Steel tube structure, welded, brushed and chrome-plated. Diffuser support in die-cast, polished and chrome-plated Zamak alloy. Injection-molded PA6 (nylon) lamp-cover. Color: white. Injection-molded PC (polycarbonate) inner diffuser. Color: 3% opal. Injection-molded elastic PVC (polyvinylchloride) feet. Lathe-shaped aluminum diffusers, painted white on the inside, and shiny white or black on the outside or gray-colored, blown and overlaid glass with glossy external finish. On the cable there is the electronic dimmer which allows the regulation of light brightness.

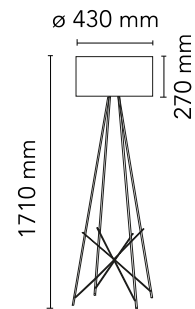

Are you a professional and your project needs consulting and support?

[BOOK AN APPOINTMENT](#)

### Main specifications

Mounting	Floor
Environments	Indoor dry location
Light Source Type	Bulb
Lamp category	Halogen
Lamp holders	E27
Iicos	HSGS
Number of heads	1
Power (W)	250

### Physical

Colour	Black
Length (mm)	430
Cord length (mm)	1900
Net weight (kg)	5.95
Package height (mm)	0
Package width (mm)	0
Package length (mm)	0
Package volume (m3)	0.44
IP internal	20

### Download

[Mounting instructions](#) PDF

[Spare Parts](#) PDF

### Photometric Files

[LDT / IES](#) LDT

### Technical Drawings

[2D](#) ZIP

[3D](#) ZIP



IP
20

## Schematic light drawing

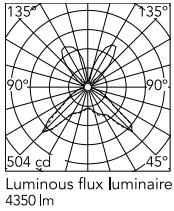

### Photometric

Lighting type	Indirect, Direct
Light distribution	Asymmetric

### Electrical

Insulation class	II
Frequency (Hz)	50/60
Main voltage (Vac)	220-240
LED voltage Vf (Vdc)	null
Dimmable	Yes
Dimming interface	Dimmer Integrated
Plug type	Type C
Batteries inside	No

## Bulbs



NOT INCLUDED

RF26998

LED 21W E27 2450lm 3000K  
DIMMER



NOT INCLUDED

RF30429

LED Opal Lamp E27 21W 2700K  
A65 Dimmable

## Spare Parts



- |     |   |           |
|-----|---|-----------|
| 01. | F2-S diffuser                             | RF16082   |
| 02. | F2-S diffuser support                     | RF15853   |
| 03. | Porcelain E27 lamp holder                 | RF04487   |
| 04. | Kit of quantity 4 adjustable feet         | RF5912100 |
| 05. | Led rondo' dimmer 220/240v 40-250w 4-100w | RF28045   |

**DOWNLOAD**



RF16082  
F2-S diffuser



RF15853  
F2-S diffuser support



RF04487  
Porcelain E27 lamp holder



RF5912100  
Kit of quantity 4 adjustable feet



RF28045  
Led rondo' dimmer 220/240v 40-250w 4-100w

# FLOS

F5916009 White

## Ray Floor 1

Designed by Rodolfo Dordoni, 2006

Halogen - 150W



Floor lamp providing diffused lighting. Steel tube (10 mm diam.) structure, welded, brushed and chrome-plated. Diffuser support disk in die-cast, polished and chrome-plated Zamak alloy. Injection-molded PA6 (nylon) lamp-cover. Color: white. Injection-molded PC (polycarbonate) inner diffuser. Color: 3% opal. Injection-molded elastic PVC (polyvinylchloride) feet. Lathe-shaped aluminum diffusers, painted white on the inside, and shiny white or black on the outside or gray-colored, blown and overlaid glass with glossy external finish. On the cable there is the electronic dimmer which allows the regulation of light brightness.

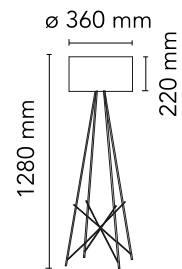

Are you a professional and your project needs consulting and support?

[BOOK AN APPOINTMENT](#)

### Main specifications

Mounting	Floor
Environments	Indoor dry location
Light Source Type	Bulb
Lamp category	Halogen
Lamp holders	E27
Iicos	HSGS
Number of heads	1
Power (W)	150

### Physical

Colour	White
Length (mm)	360
Cord length (mm)	2300
Net weight (kg)	5.45
Package height (mm)	0
Package width (mm)	0
Package length (mm)	0
Package volume (m3)	0.21
IP internal	20

### Download

<a href="#">Mounting instructions</a>	<a href="#">↓ PDF</a>
<a href="#">Spare Parts</a>	<a href="#">↓ PDF</a>

### Photometric Files

<a href="#">LDT / IES</a>	<a href="#">↓ LDT</a>
---------------------------	-----------------------

### Technical Drawings

<a href="#">2D</a>	<a href="#">↓ ZIP</a>
<a href="#">3D</a>	<a href="#">↓ ZIP</a>



IP
20

## Schematic light drawing

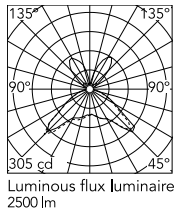

### Photometric

Lighting type	Indirect, Direct
Light distribution	Asymmetric

### Electrical

Insulation class	II
Frequency (Hz)	50/60
Main voltage (Vac)	220-240
LED voltage Vf (Vdc)	null
Dimmable	Yes
Dimming interface	Dimmer Integrated
Plug type	Type C
Batteries inside	No

## Bulbs

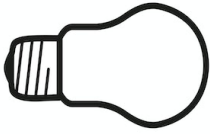

NOT INCLUDED

RF32563

LED Lamp 11.5W E27 220-240V  
2700K A70



NOT INCLUDED

RF32564

LED Lamp 11.5W E27 220-240V  
3000K A70



## Spare Parts

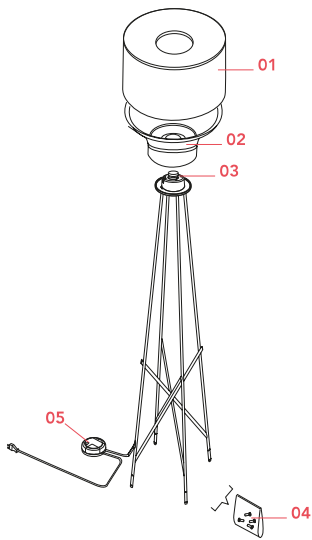

- |     |   |           |
|-----|---|-----------|
| 01. | F1-T diffuser                             | RF16085   |
| 02. | F1-T diffuser support                     | RF15854   |
| 03. | Porcelain E27 lamp holder                 | RF04487   |
| 04. | Kit of quantity 4 adjustable feet         | RF5912100 |
| 05. | Led rondo' dimmer 220/240v 40-250w 4-100w | RF28045   |

**DOWNLOAD**



RF16085

F1-T diffuser



RF15854

F1-T diffuser support



RF04487

Porcelain E27 lamp holder



RF5912100

Kit of quantity 4 adjustable feet



RF28045

Led rondo' dimmer 220/240v 40-250w 4-100w