



Index

CODE

Finishes	p. 4
Synoptic table of the components	p. 8
Details	p. 12
Examples of use	p. 13
Technical drawings	p. 14
Technical description of materials	p. 75
Notes	p. 75
Composition elements	p. 76
Construction examples	p. 80
System modularity	p. 81
Lateral sides - Finishing top	p. 82
Storage units	p. 82
Open storage units	p. 86
Storage units Living	p. 88
Accessories for storage units Living	p. 91
Open storage units Living	p. 92
TV-portal	p. 95
Inner equipment for drawers	p. 99
Hanging storage units	p. 100
Accessories for hanging storage units	p. 101
Bookshelves	p. 102
SURFACE wall panelling	
See ARCHITECTURAL price list	
Shelves for SURFACE wall panelling	p. 103
Hanging thick shelves for SURFACE wall panelling	p. 104
Shelves for wall fixing	p. 105
Hanging thick shelves for wall fixing	p. 106
Lighting system	p. 107
Optional	p. 109
Optional for thick shelves	p. 110
Cables passage arrangement	p. 111
Order example	p. 113
Order form	p. 115

Finishes

Plinth - Handles - Glass doors frames

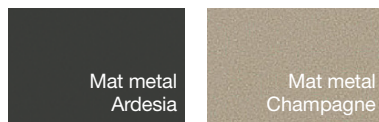

Storage units: structure - backs

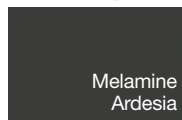

Storage units: fronts

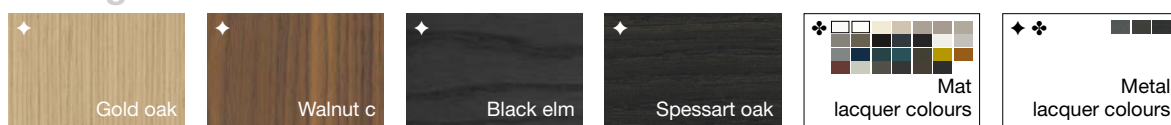

- ◆ For grain direction see page 7.
- ♣ For colours see page 7.

Storage units Living: structure - backs

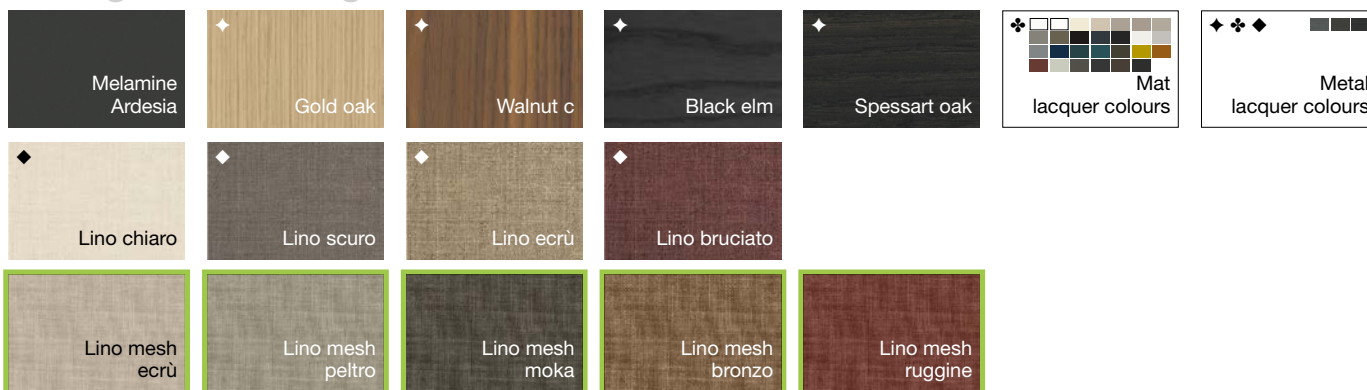

- ◆ For grain direction see page 7.
- ♣ For colours see page 7.
- ◆ Available only for backs.

Storage units Living: fronts

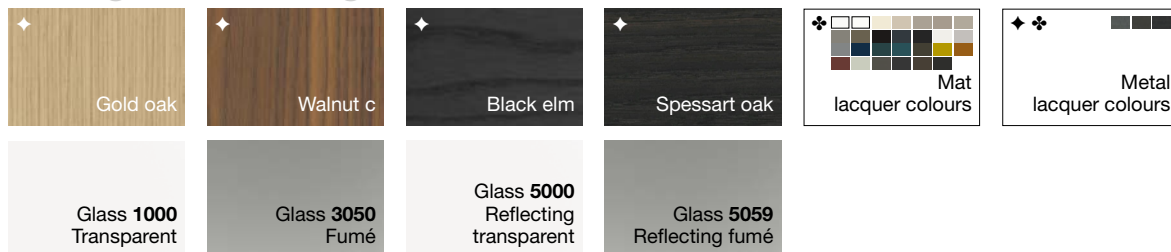

- ◆ For grain direction see page 7.
- ♣ For colours see page 7.

Finishes

Hanging storage units: structure - backs



- ◆ For grain direction see page 7.
- ✦ For colours see page 7.
- ◆ Available only for backs.

Hanging storage units: fronts

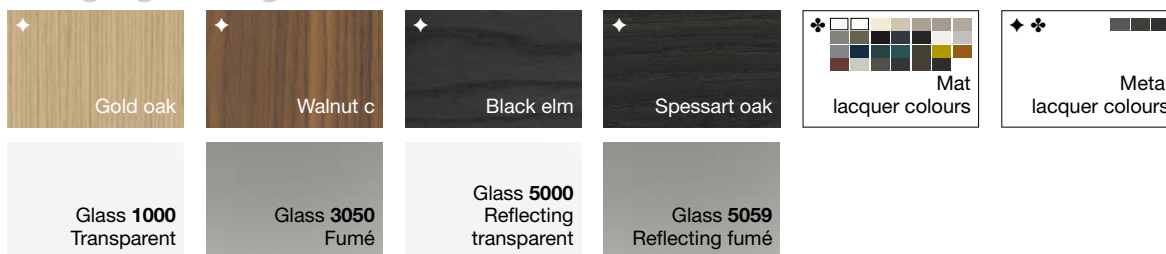

- ◆ For grain direction see page 7.
- ✦ For colours see page 7.

Open storage units: structure - backs



- ✦ For colours see page 7.

Open storage units Living - bookshelves: structure



- ✦ For colours see page 7.

Open storage units Living - bookshelves: backs

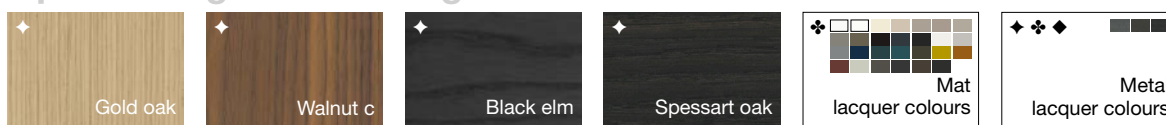

- ◆ For grain direction see page 7.
- ✦ For colours see page 7.

Finishes

Lateral sides

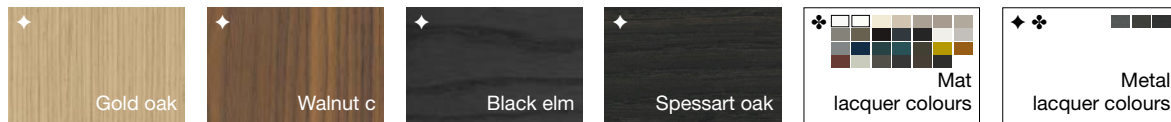

Finishing top

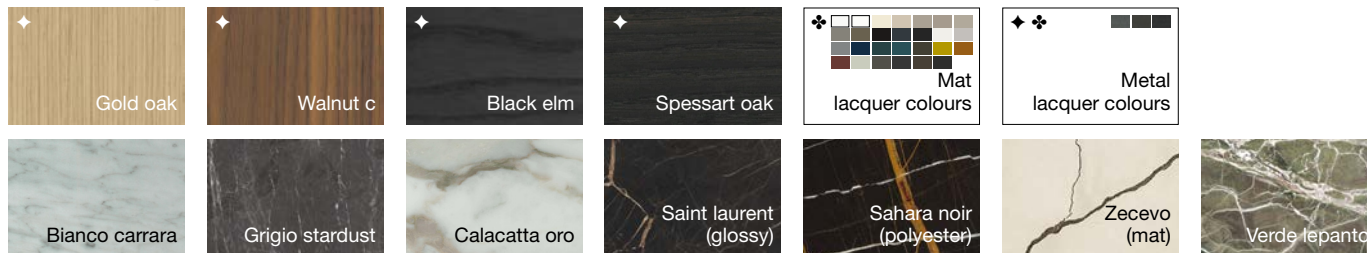

Note:

Marble is a natural material with unique characteristics from piece to piece. The product can be different from the indicative sample. For more information see the "marble technical features" in the section Information.

Shelves

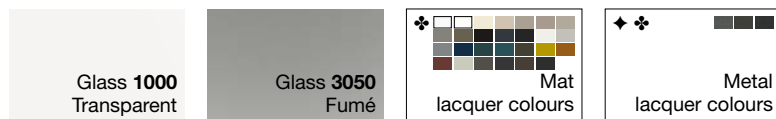

Thick shelf

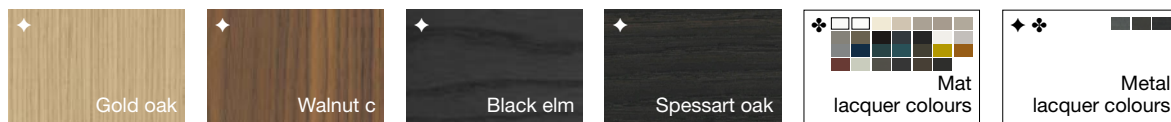

Inner shelves

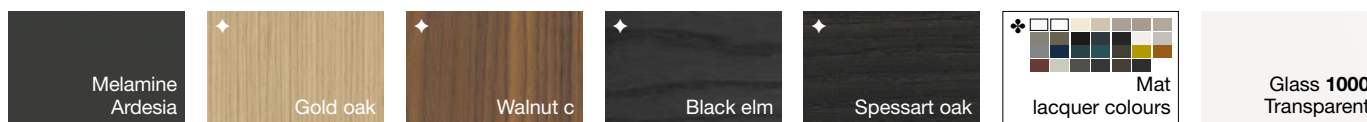

Finishes

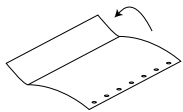

Optional drawers bottoms (Tecnocover grain)



Mat lacquer



Metal lacquer

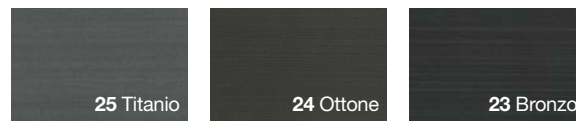

Note:
The metal lacquers are made through artisan production processes, any slight variations in tone are therefore characteristic of this finishing and not a production defect.

Notes wood / metal lacquer grain direction:

- sideboards storage units fronts: horizontal
- sideboards storage units backs: horizontal
- sideboards rear back: horizontal
- high sideboards storage units fronts: vertical
- high sideboards storage units backs: vertical
- high sideboards rear back: vertical
- lateral sides: vertical
- finishing top: horizontal
- benches: horizontal

Example of using outward opening page

this allows the simultaneous consultation of the synoptic table

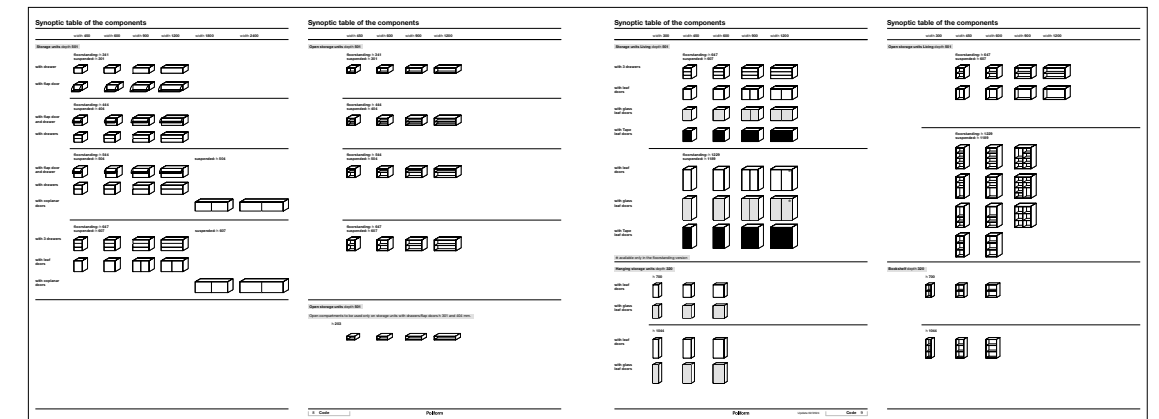

The following elements are available:

- floorstanding - suspended storage units
- floorstanding - suspended open storage units
- floorstanding - suspended storage units Living
- floorstanding - suspended open storage units Living

Synoptic table of the components

	width 450	width 600	width 900	width 1200	width 1800	width 2400
Storage units depth 501						
	floorstanding: h 341 suspended: h 301					
with drawer						
with flap door						
<hr/>						
	floorstanding: h 444 suspended: h 404					
with flap door and drawer						
with drawers						
<hr/>						
	floorstanding: h 544 suspended: h 504			suspended: h 504		
with flap door and drawer						
with drawers						
with coplanar doors						
<hr/>						
	floorstanding: h 647 suspended: h 607			suspended: h 607		
with 3 drawers						
with leaf doors						
with coplanar doors						

Synoptic table of the components

	width 450	width 600	width 900	width 1200
Open storage units depth 501				
	floorstanding: h 341 suspended: h 301			
<hr/>				
	floorstanding: h 444 suspended: h 404			
<hr/>				
	floorstanding: h 544 suspended: h 504			
<hr/>				
	floorstanding: h 647 suspended: h 607			

Open storage units depth 501

Open compartments to be used only on storage units with drawers/flap doors h 301 and 404 mm.

h 203

Synoptic table of the components

width 300 width 450 width 600 width 900 width 1200

Storage units Living depth 501

floorstanding: h 647
suspended: h 607

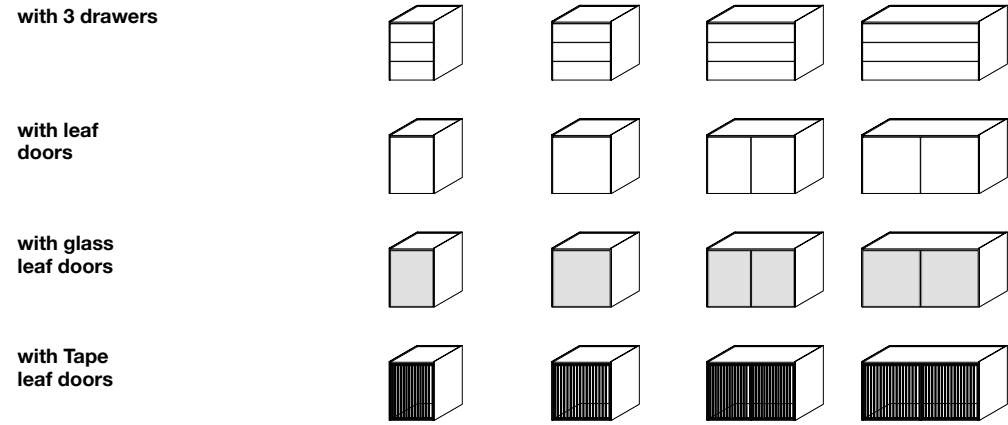

floorstanding: h 1229
suspended: h 1189

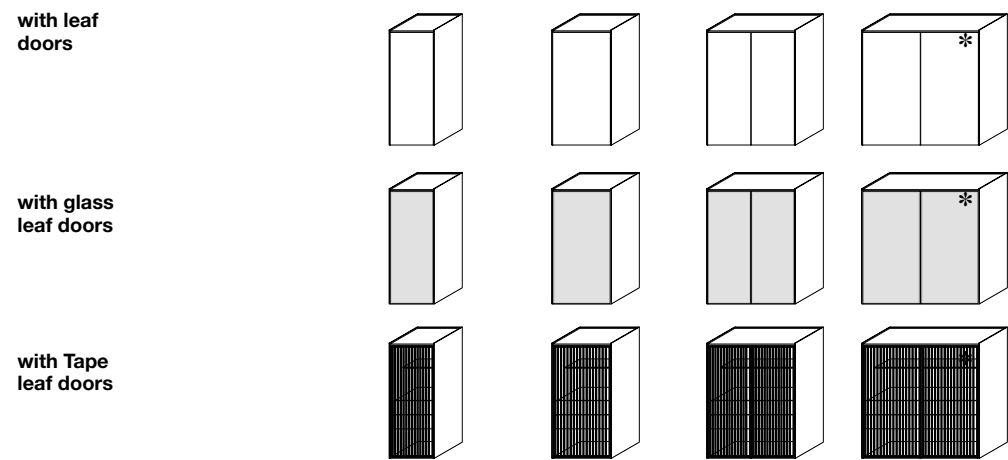

* available only in the floorstanding version

Hanging storage units depth 320

h 700

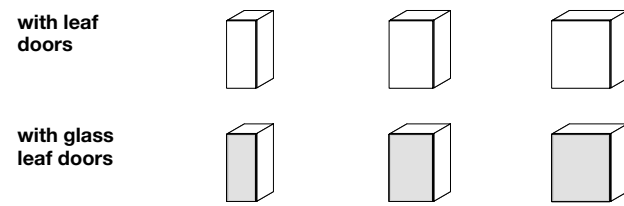

h 1044

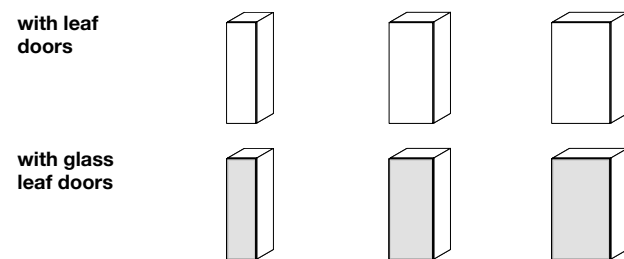

Synoptic table of the components

width 300 width 450 width 600 width 900 width 1200

Open storage units Living depth 501

floorstanding: h 647
suspended: h 607

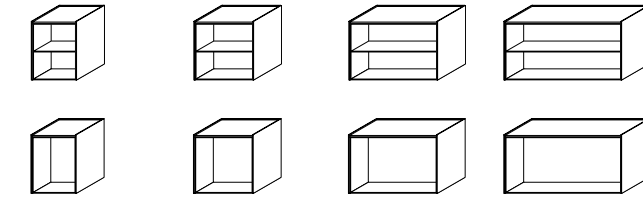

floorstanding: h 1229
suspended: h 1189

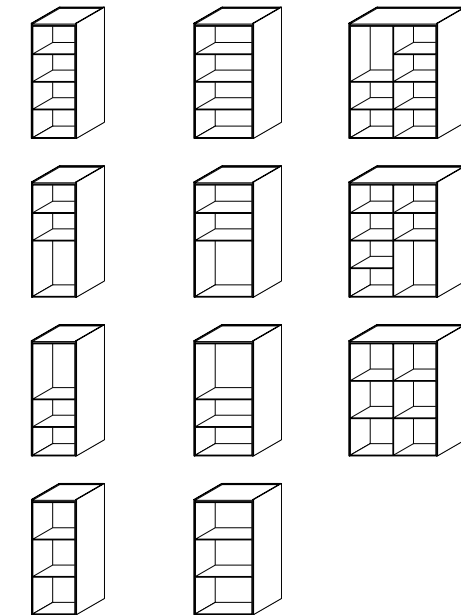

Bookshelf depth 320

h 700

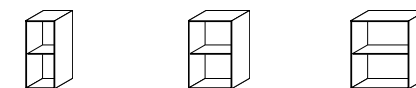

h 1044

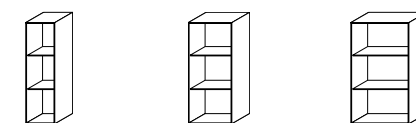

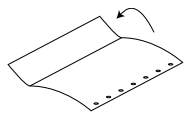

Synoptic table of the components

TV-portal
width 1800

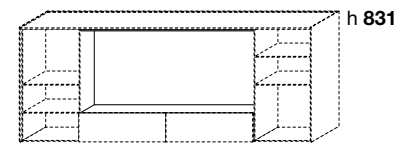

Finishing top th 14 - 18

 width 450

 width 600

 width 750

 width 900

 width 1050

 width 1200

 width 1350

 width 1500

 width 1650

 width 1800

 width 1950

 width 2100

 width 2250

 width 2400

 width 2550

 width 2700

 width 2850

 width 3000

Lateral sides depth 501 - th 8
for storage units - open storage units
for storage units Living - open storage units Living

h 301



h 404



h 504



h 607



h 1189

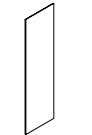

Synoptic table of the components

Shelves for wall fixing depth 280 - th 8

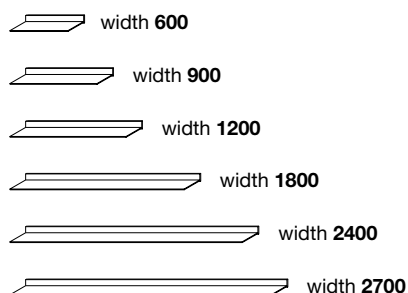

Shelves for SURFACE wall panelling depth 280 - th 8

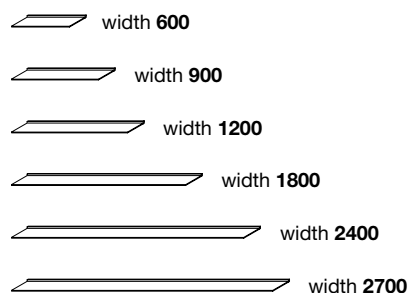

Glass shelves for wall fixing depth 280 - th 8

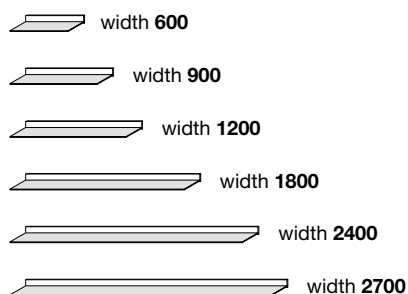

Glass shelves for SURFACE wall panelling depth 280 - th 8

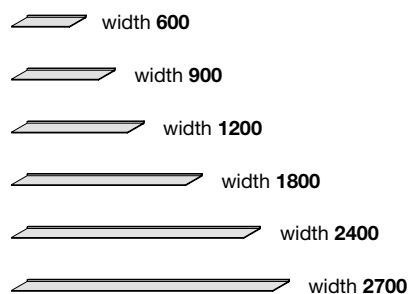

Hanging thick shelf for wall fixing depth 501 - h 60

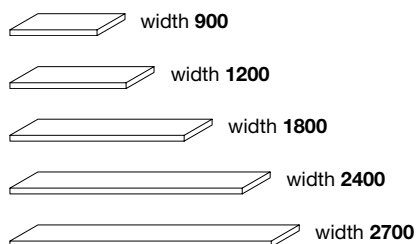

Hanging thick shelf for SURFACE wall panelling depth 501 - h 60

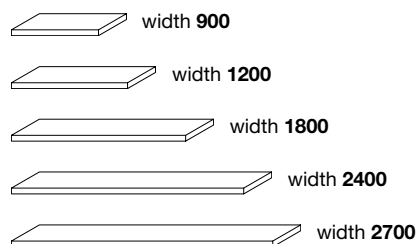

Hanging thick shelf for wall fixing with channel depth 501 - h 60

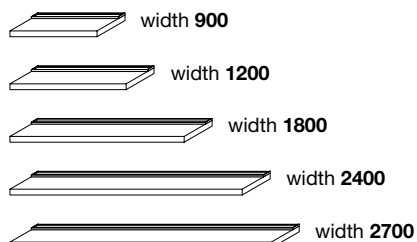

Hanging thick shelf for SURFACE wall panelling with channel depth 501 - h 60

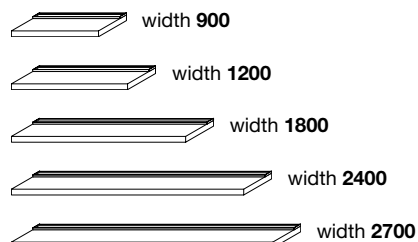

Details

DIFFERENCES:

Floorstanding / suspended storage units



- The finishing top is set back from the front (top depth 473 mm)
- The fronts are shaped to allow the opening.
- In case of two or more fronts, the upper one will be shaped, the others will have a pressure opening.

Finishes floorstanding / suspended storage units:

Structure:

- melamine ardesia

Backs:

- melamine ardesia

Fronts:

- lacquer: mat colours - metal
- wood: gold oak - walnut c - black elm - Spessart oak

Plinth / Upper profile: metal: ardesia mat - champagne mat

Finishes floorstanding / suspended open storage units:

Structure: lacquer: mat colours

Backs:

- mat lacquer colours (always included in the price)

Plinth / Upper profile: metal: ardesia mat - champagne mat

Floorstanding / suspended storage units Living



- The finishing top overcomes the fronts (top depth 480 mm)
- Doors with handle.
- Drawers with pressure opening.

Finishes floorstanding / suspended storage units Living:

Structure:

- melamine ardesia
- mat lacquer colours
- wood: gold oak - walnut c - black elm - Spessart oak

Backs:

- melamine ardesia
- lacquer: mat colours - metal
- wood: gold oak - walnut c - black elm - Spessart oak
- fabric: lino chiaro - lino scuro - lino ecrù - lino bruciato - lino mesh ecrù - lino mesh peltro - lino mesh moka - lino mesh bronzo - lino mesh ruggine

Fronts:

- lacquer: mat colours - metal
- wood: gold oak - walnut c - black elm - Spessart oak
- glass (leaf doors): transparent - fumé - reflecting transparent - fumé reflecting

Plinth / Upper profile: metal: ardesia mat - champagne mat

Finishes floorstanding / suspended open storage units Living:

Structure: lacquer: mat colours

Backs:

- lacquer: mat colours - metal
- wood: gold oak - walnut c - black elm - Spessart oak
- fabric: lino chiaro - lino scuro - lino ecrù - lino bruciato

Plinth / Upper profile: metal: ardesia mat - champagne mat

Optional:

Cables passage



Thick shelf with channel



Optional available only for hanging thick shelf:

Channel with cables module



Channel equipped with optional cables module

Channel with wireless charger



Channel equipped with optional wireless charger
It allows induction charging

Examples of use

Code is a transversal system that can be used in multiple environments:

- Living and Dining area: Day Systems and sideboards system (Complements price list)
- Night Area: Vanity (Night Systems price list), Day Systems and night complements (Complements price list)

Code Day Systems



Living room:
TV-portal with storage units Living
and open storage units Living



Living room:
bookshelves, hanging thick shelf
and SURFACE wall panelling



Living room:
storage units, hanging thick shelf,
shelves and SURFACE wall panelling



Living room:
storage units, open storage units,
shelves and SURFACE
wall panelling

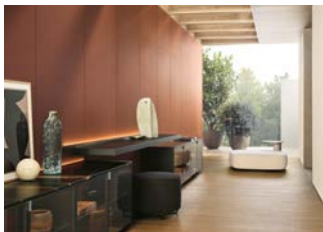

Living room:
storage units Living, hanging thick
shelf and SURFACE wall panelling



Bedroom:
storage units and hanging thick
shelf



Dining room:
storage units Living and open
storage units Living

Complements



Dining room



Living room:
sideboard



Living room:
sideboard



Bedroom:
night table

Night Systems



Bedroom:
Vanity



Bedroom:
Vanity

Floorstanding storage units

Storage units dimensions include lateral sides (8+8).

Storage unit with drawer
Storage unit with flap door
with plinth h 40 mm

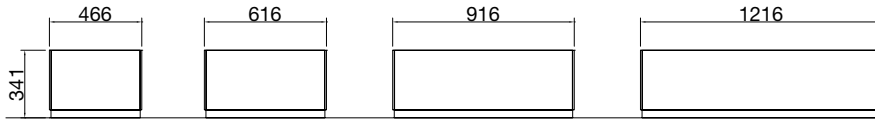

Storage unit with 2 drawers
Storage unit with drawer and flap door
with plinth h 40 mm

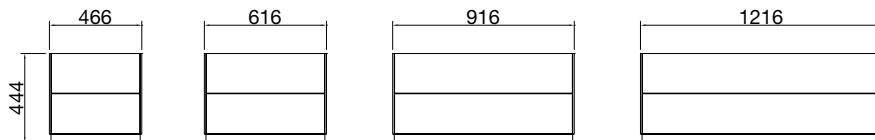

Storage unit with 2 drawers
Storage unit with drawer and flap door
with plinth h 40 mm

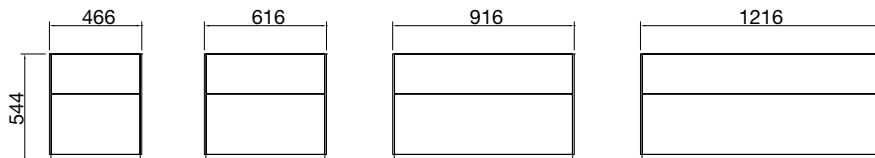

Storage unit with 3 drawers
with plinth h 40 mm

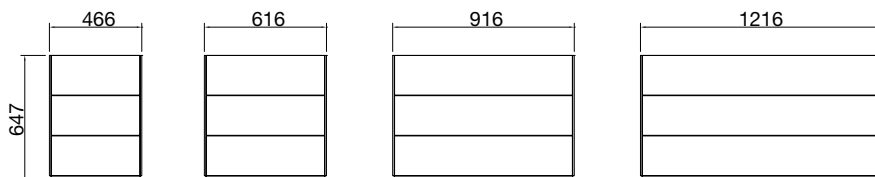

Storage unit with leaf door
with plinth h 40 mm

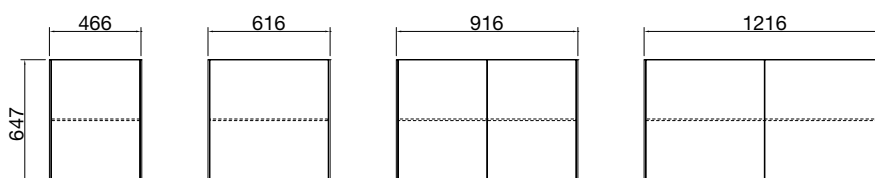

Suspended storage units

Storage units dimensions include lateral sides (8+8).

Storage unit with drawer
Storage unit with flap door

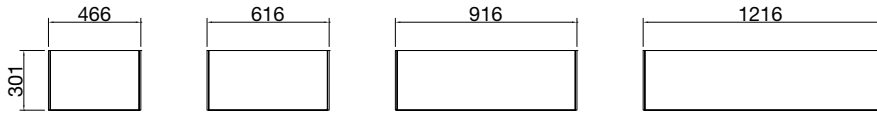

Storage unit with 2 drawers
Storage unit with drawer and flap door

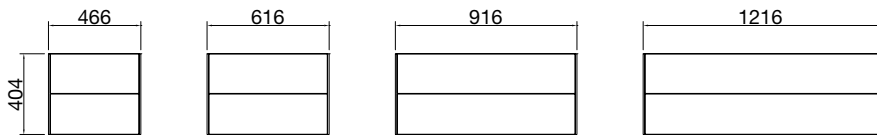

Storage unit with 2 drawers
Storage unit with drawer and flap door

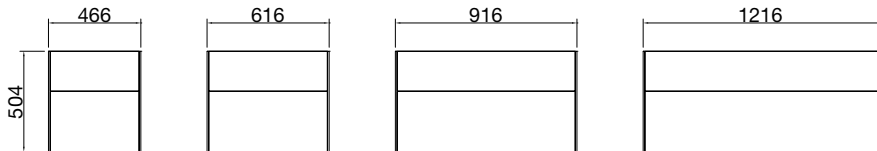

Storage unit with coplanar sliding doors

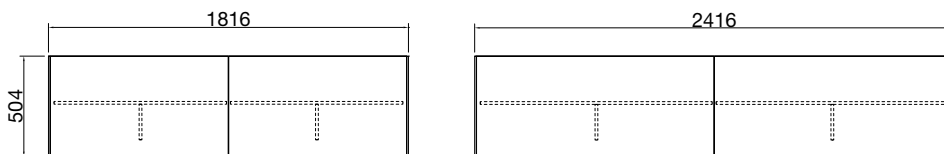

Storage unit with 3 drawers

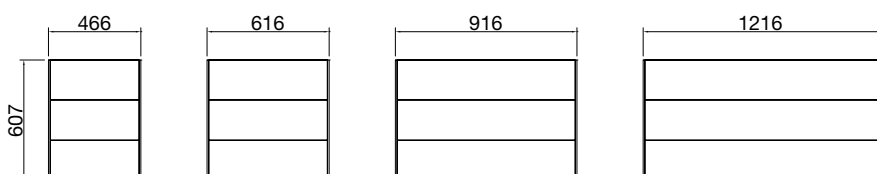

Suspended storage units

Storage units dimensions include lateral sides (8+8).

Storage unit with leaf door

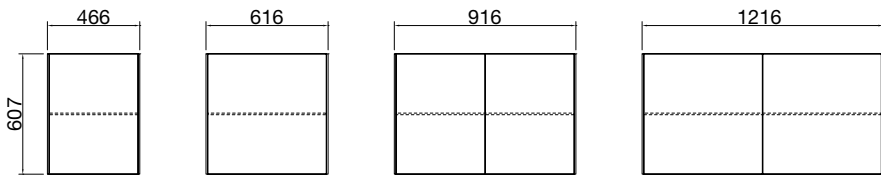

Storage unit with coplanar sliding doors

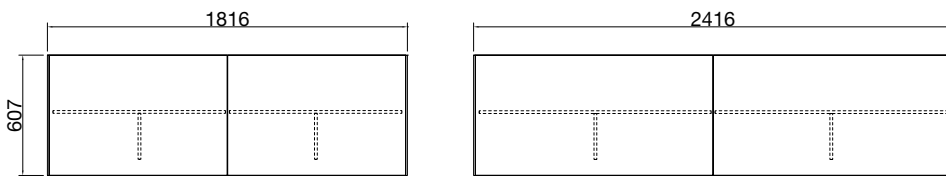

Floorstanding open storage units

Storage units dimensions include lateral sides (8+8).

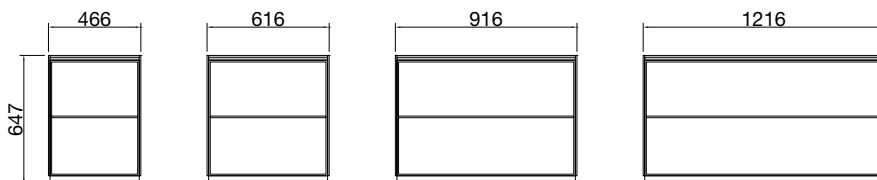
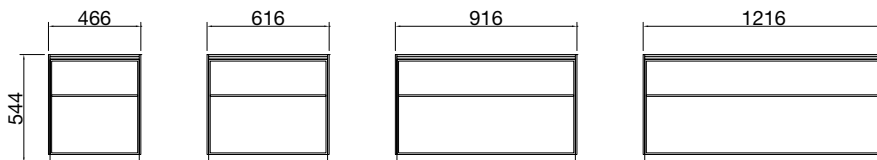
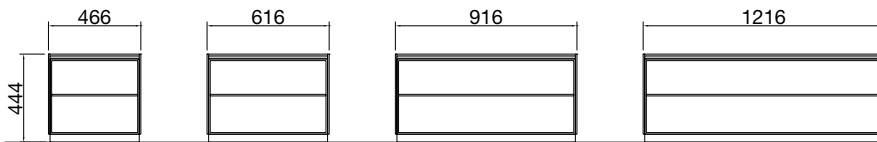
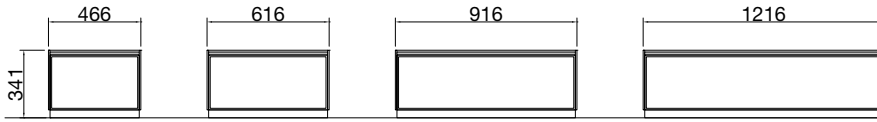

Open storage units h 203 on floorstanding storage units

Storage units dimensions include lateral sides (8+8).

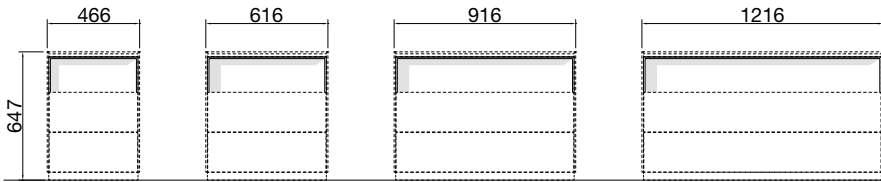
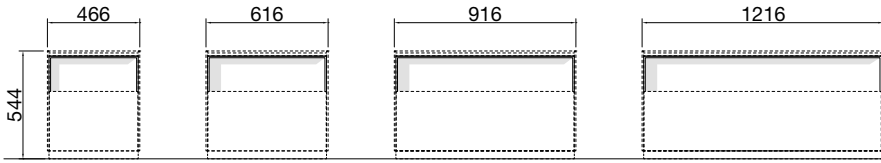

Suspended open storage units

Storage units dimensions include lateral sides (8+8).

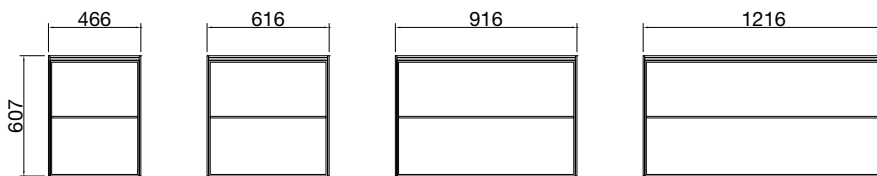
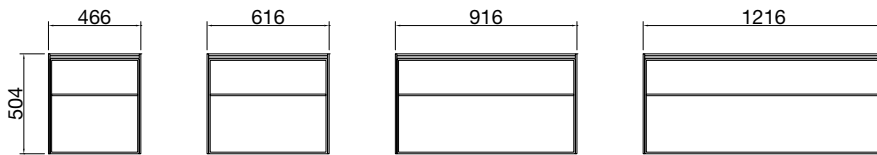
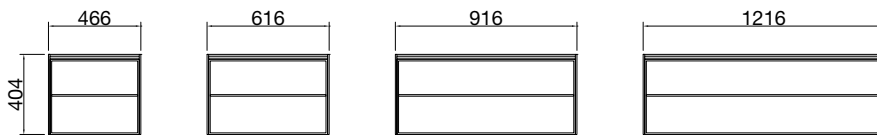
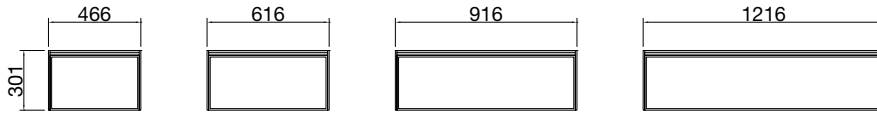

Open storage units h 203 on suspended storage units

Storage units dimensions include lateral sides (8+8).

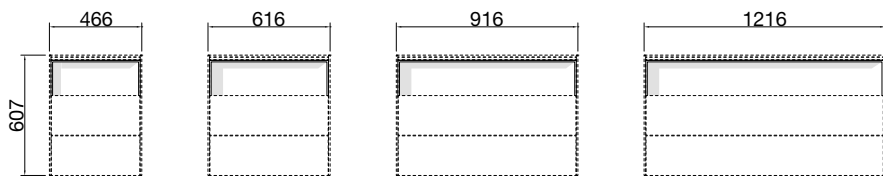
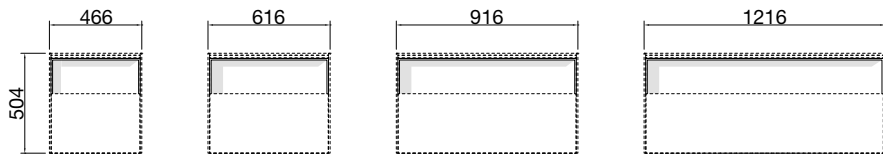

Floorstanding storage units Living

Storage units dimensions include lateral sides (8+8).

Storage unit with leaf doors with plinth h 40 mm

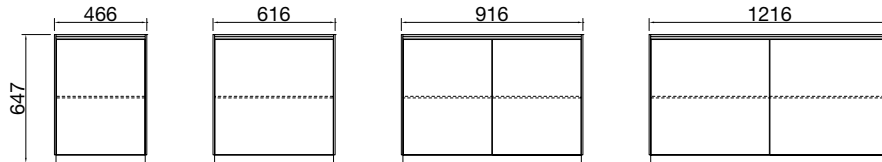

Storage unit with glass leaf doors with plinth h 40 mm

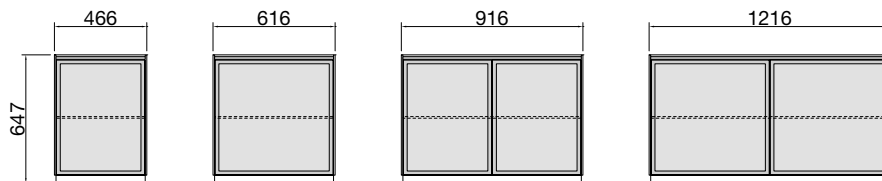

Storage unit with Tape leaf doors with plinth h 40 mm

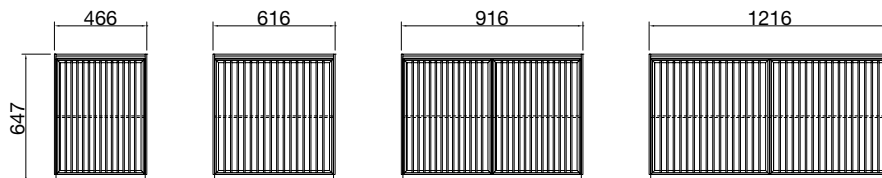

Storage unit with 3 drawers with plinth h 40 mm

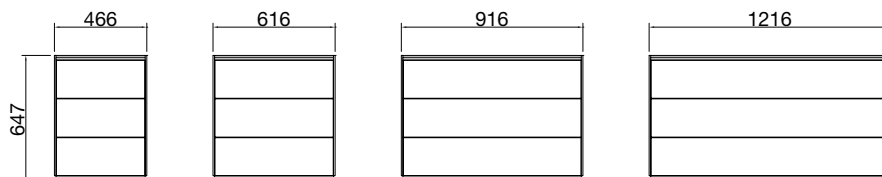

Floorstanding storage units Living

Storage units dimensions include lateral sides (8+8).

Storage unit with leaf doors with plinth h 40 mm

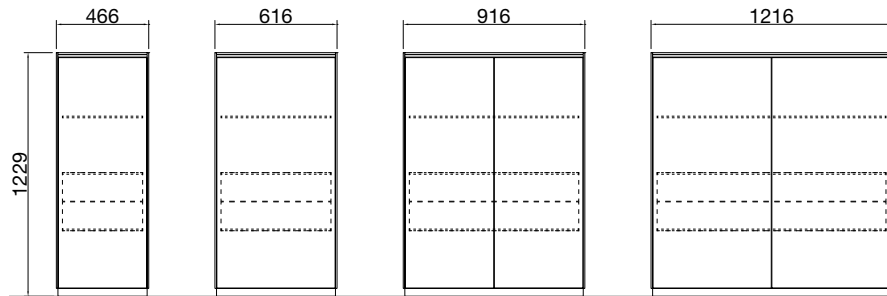

Storage unit with glass leaf doors with plinth h 40 mm

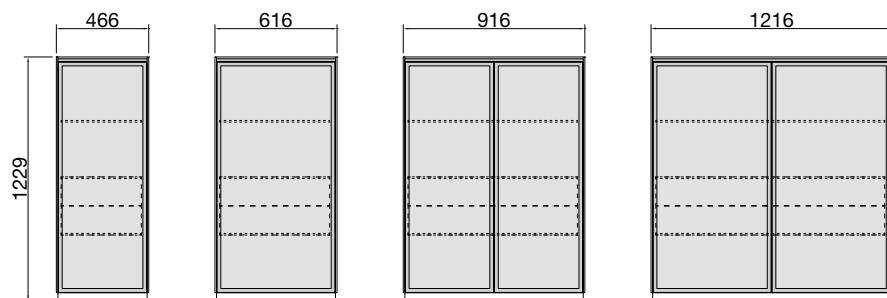

Storage unit with Tape leaf doors with plinth h 40 mm

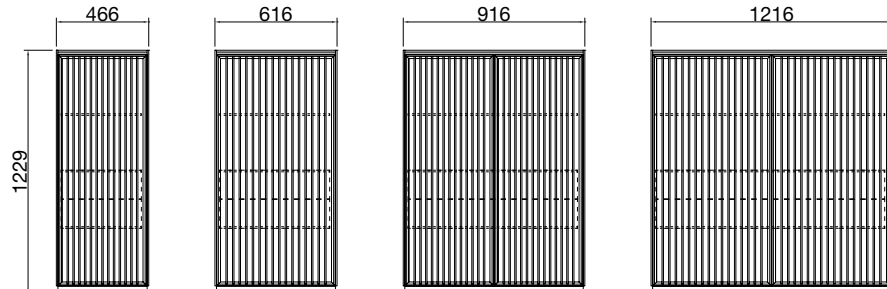

Suspended storage units Living

Storage units dimensions include lateral sides (8+8).

Storage unit with leaf doors

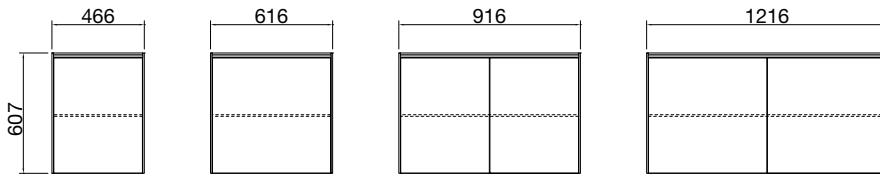

Storage unit with glass leaf doors

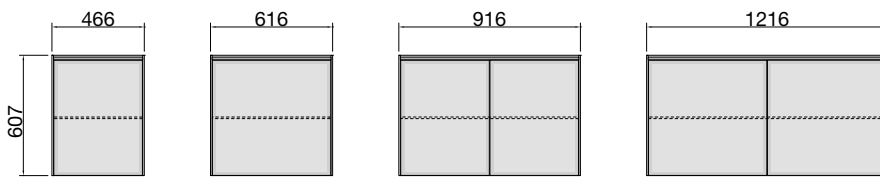

Storage unit with Tape leaf doors

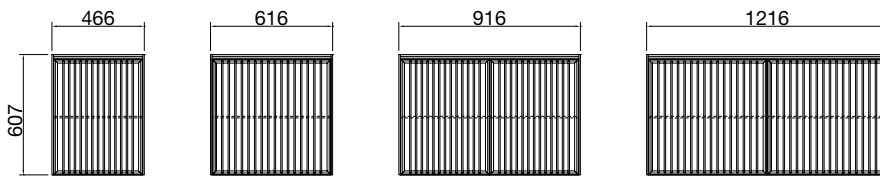

Storage unit with 3 drawers

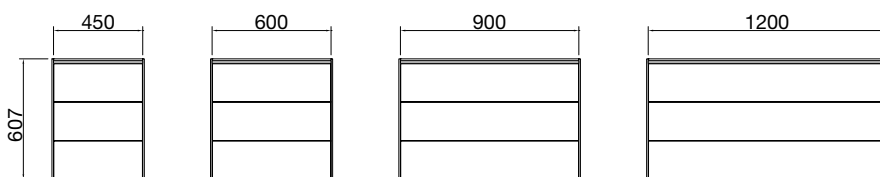

Suspended storage units Living

Storage units dimensions include lateral sides (8+8).

Storage unit with leaf doors

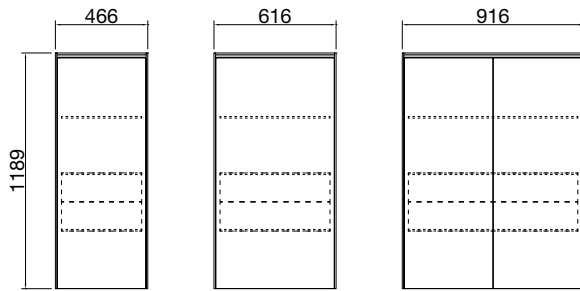

Storage unit with glass leaf doors

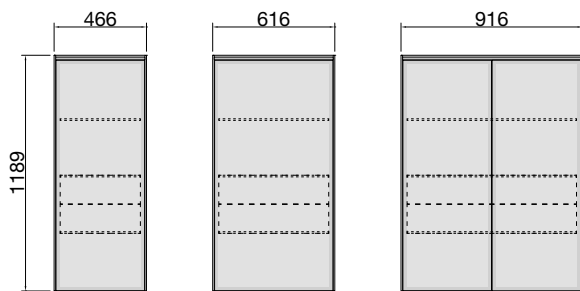

Storage unit with Tape leaf doors

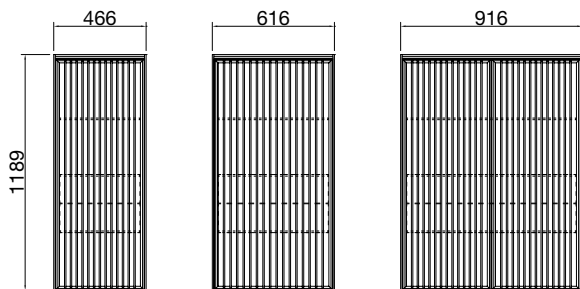

Floorstanding open storage units Living

Storage units dimensions include lateral sides (8+8).

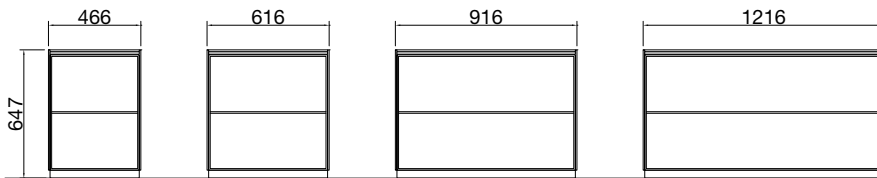
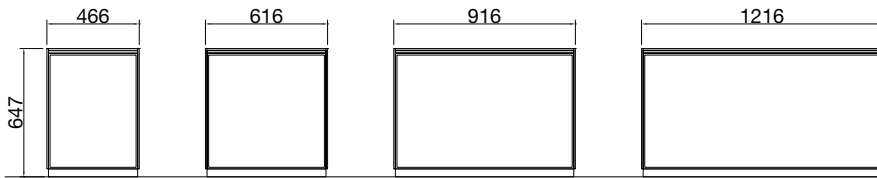

Floorstanding open storage units Living

Storage units dimensions include lateral sides (8+8).

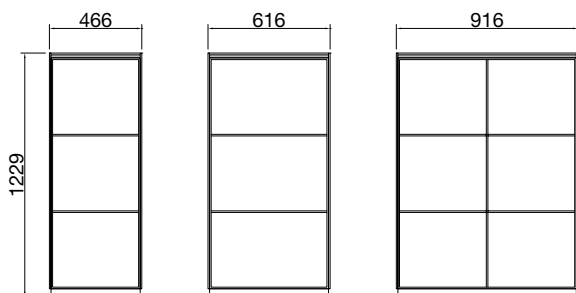
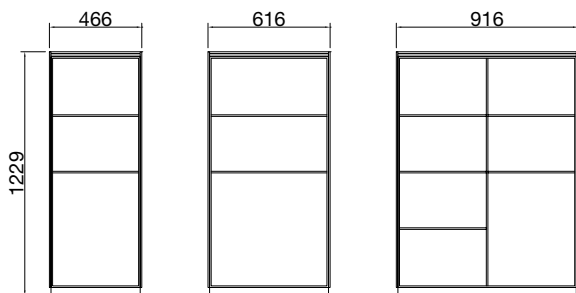
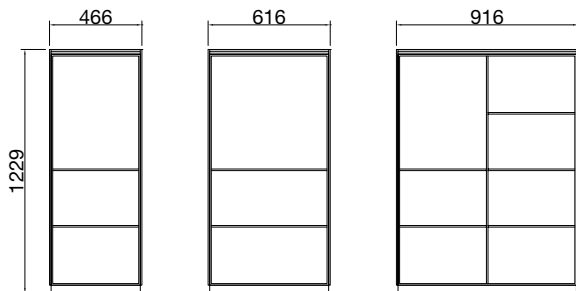
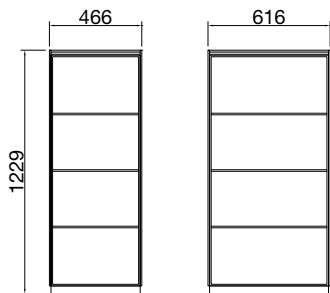

Suspended open storage units Living

Storage units dimensions include lateral sides (8+8).

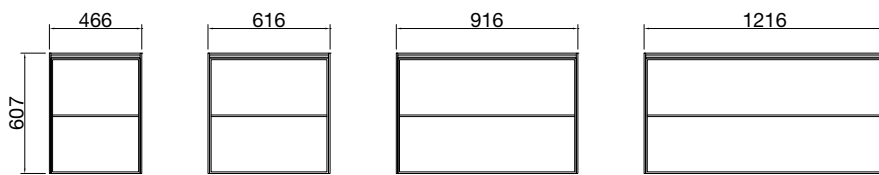
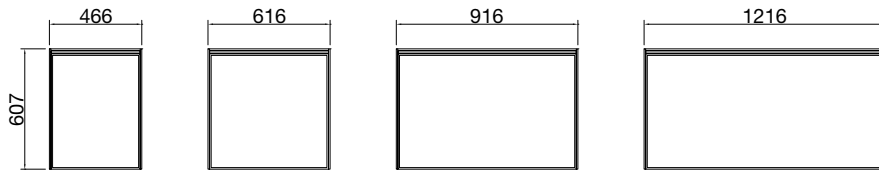

Suspended open storage units Living

Storage units dimensions include lateral sides (8+8).

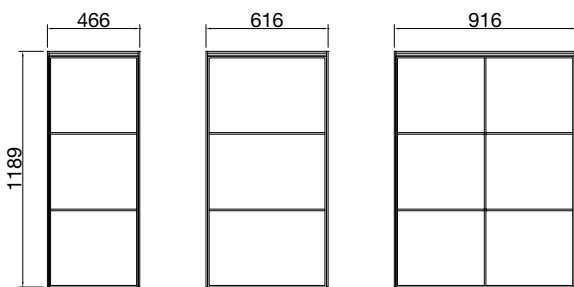
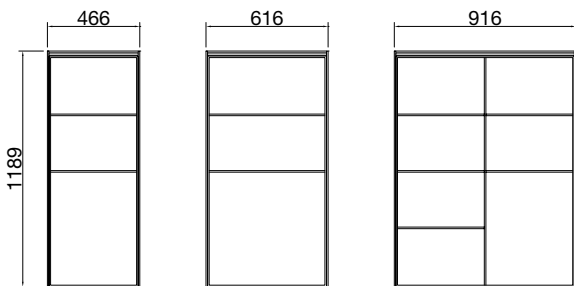
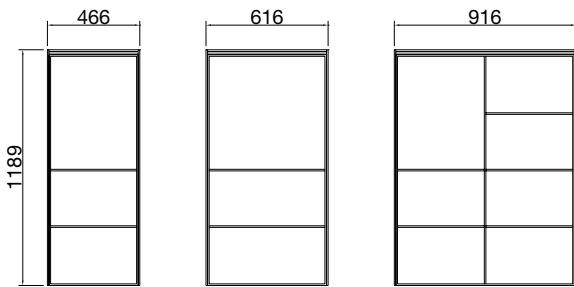
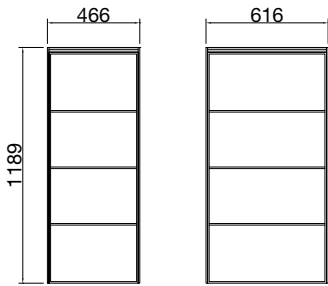

Hanging storage units

Wooden door

wooden shelves th 20 mm

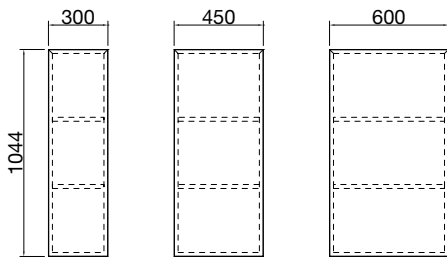
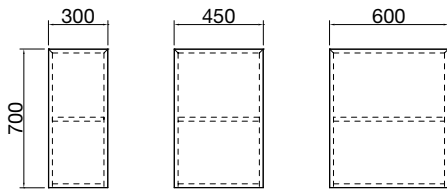

Glass door

glass shelves th 8 mm

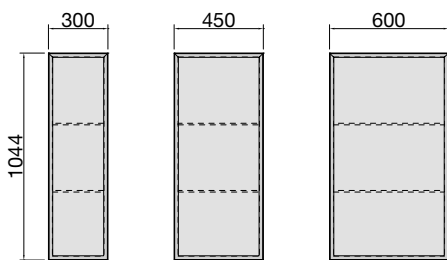
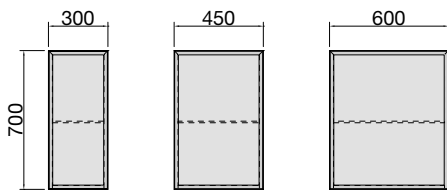

Bookshelves

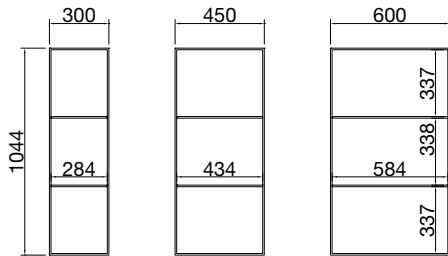
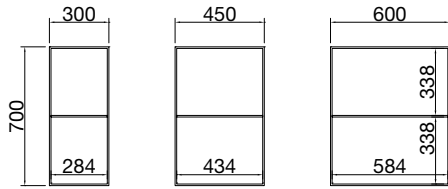

Shelves for wall fixing

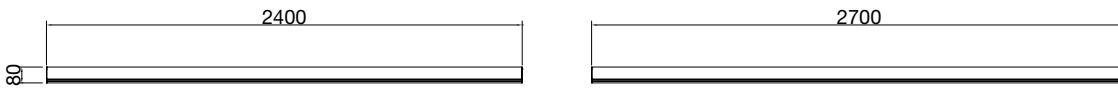
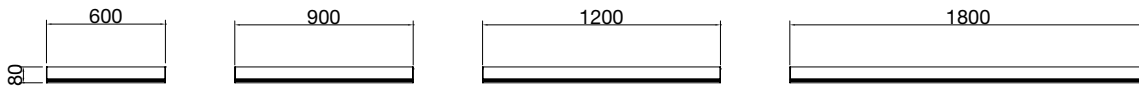

Shelves for SURFACE wall panelling

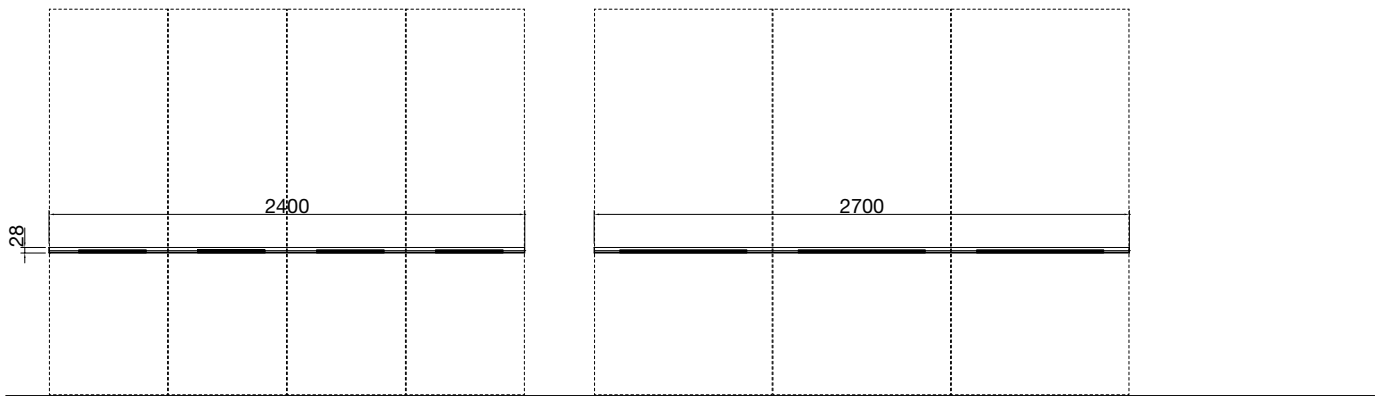
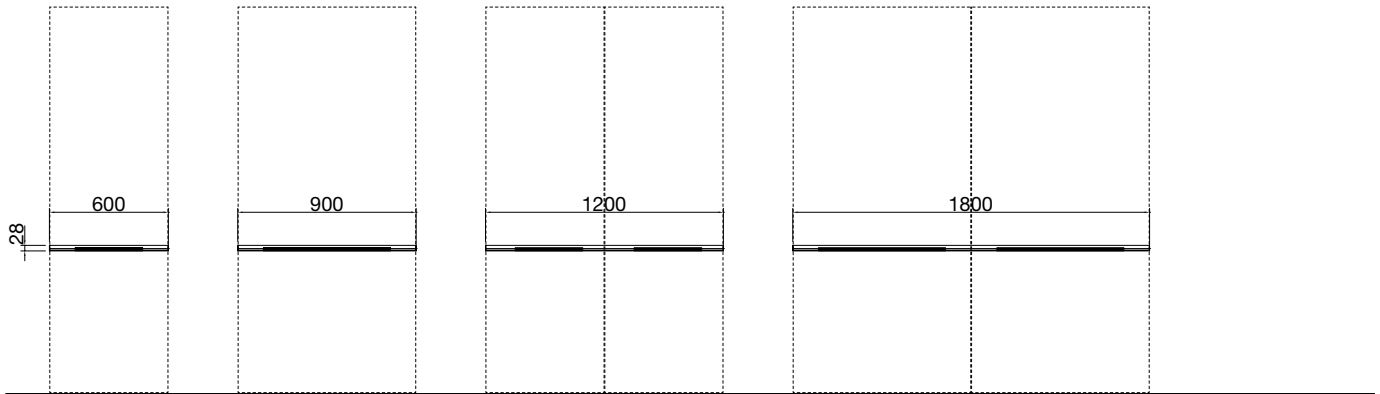

Thick shelves for wall fixing

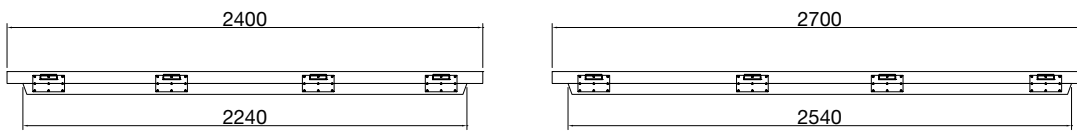
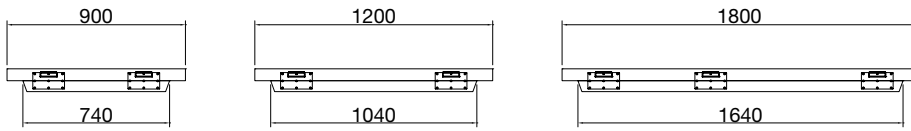

With channel

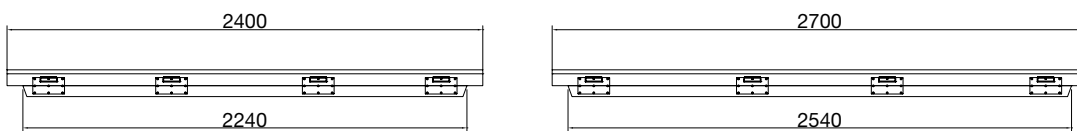
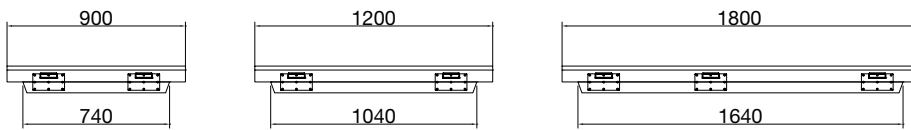

Thick shelves for SURFACE wall panelling

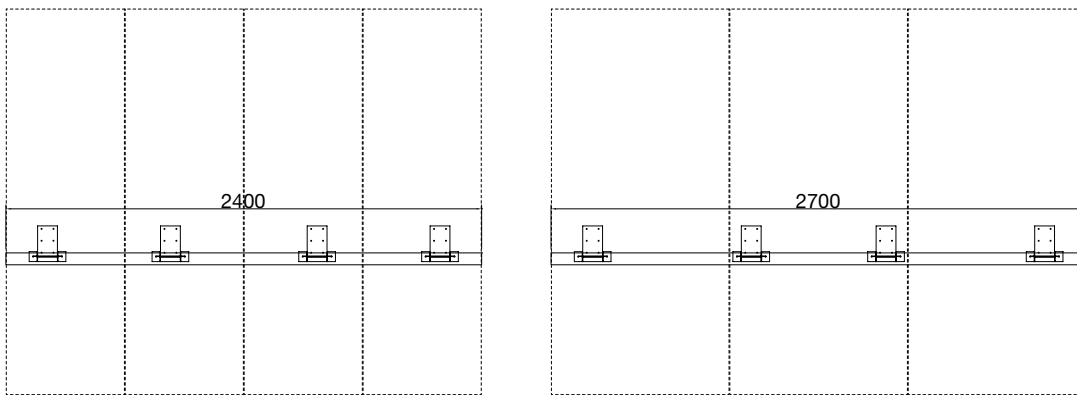
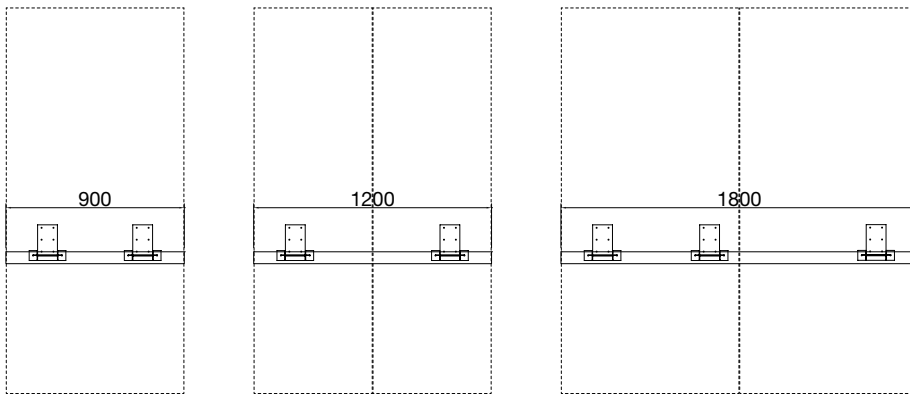

With channel

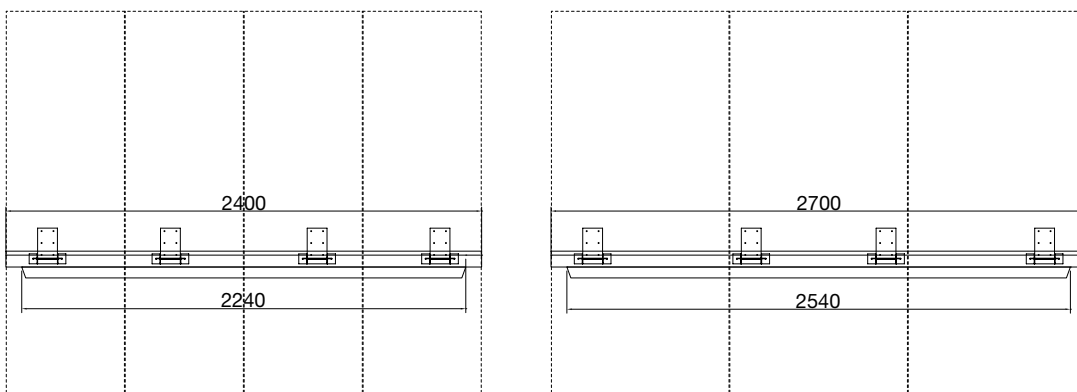
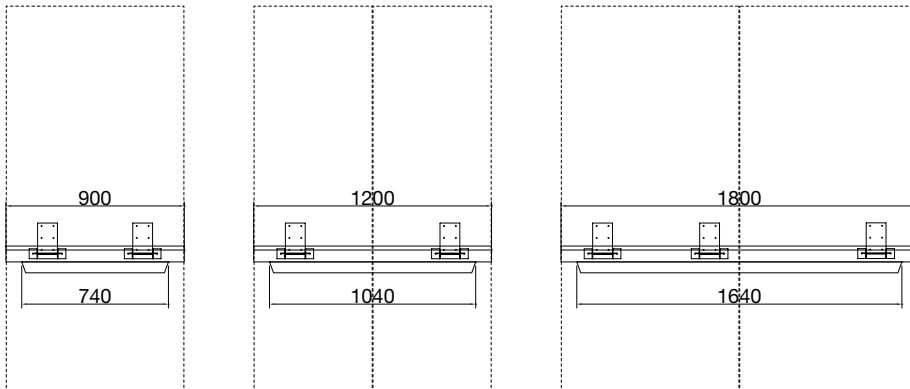

Hanging thick shelf: optional positioning

Wireless charger fixed positioning

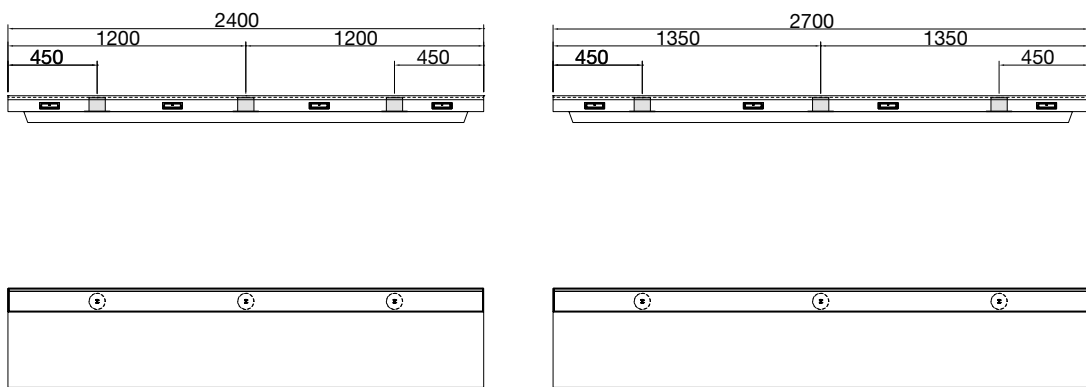
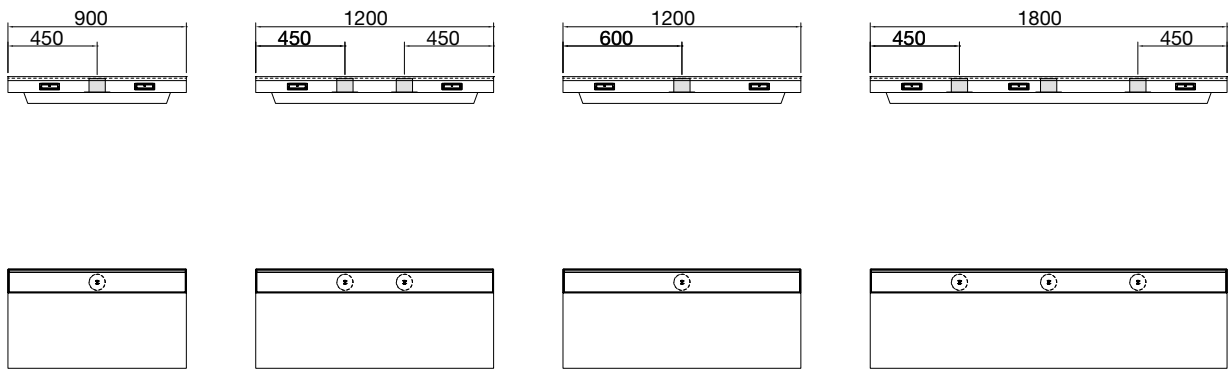

Cables module fixed positioning

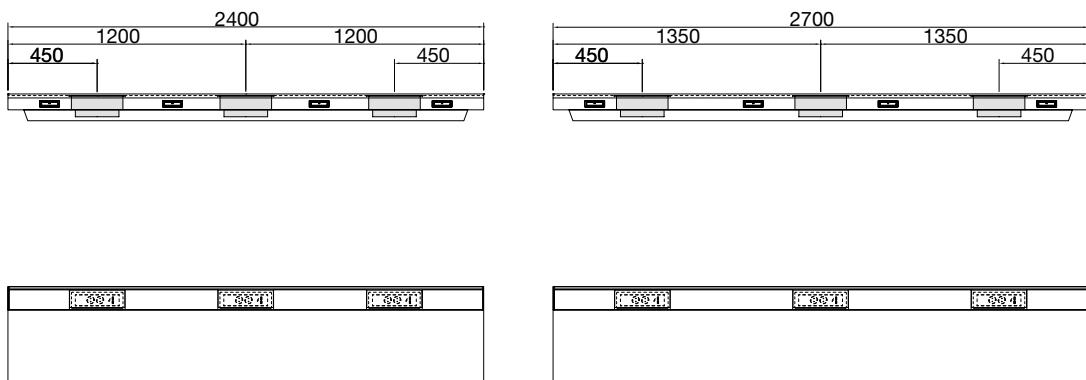
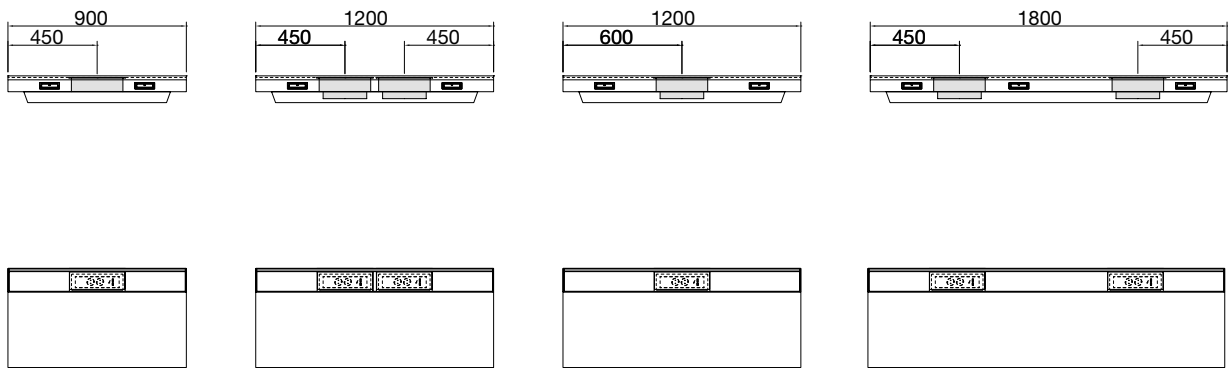

Hanging thick shelf: optional positioning

Positioning

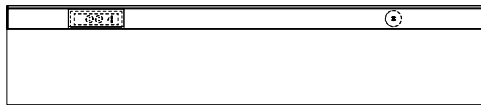
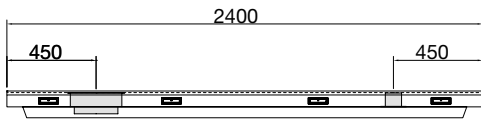
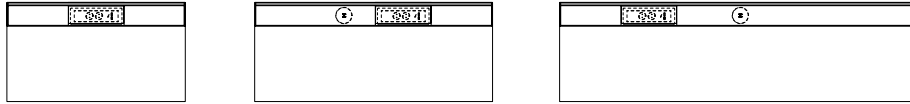
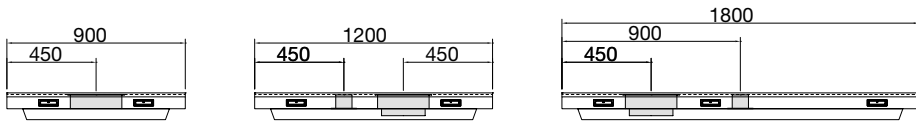

Floorstanding storage units

Storage unit with drawer

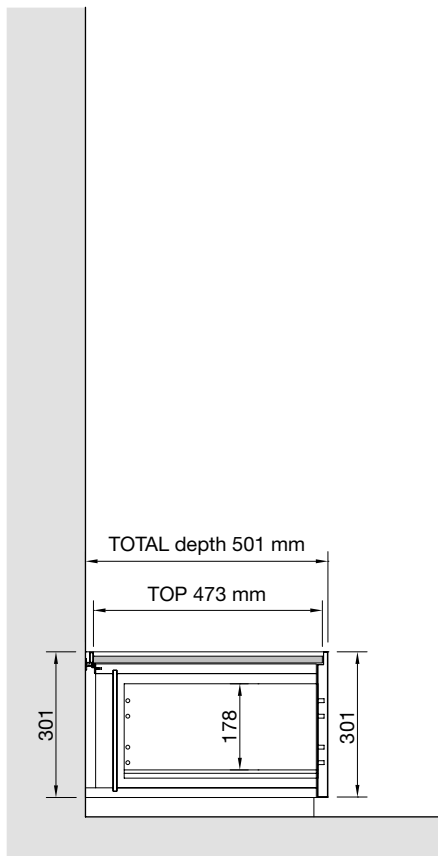

Storage unit with flap door

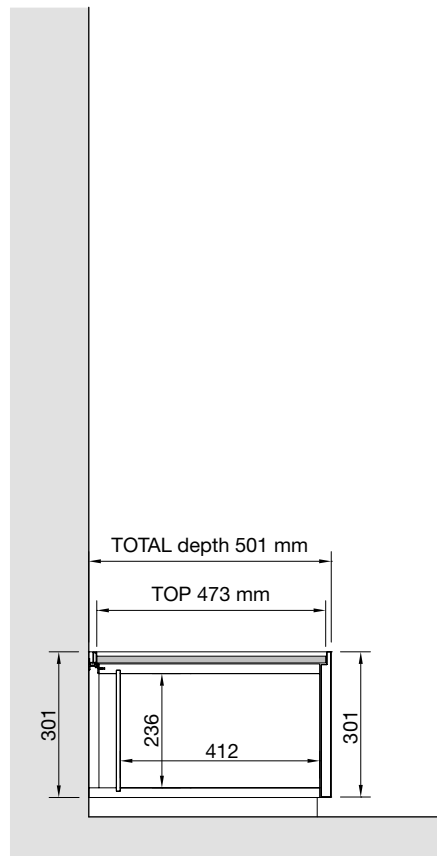

Storage unit with 2 drawers

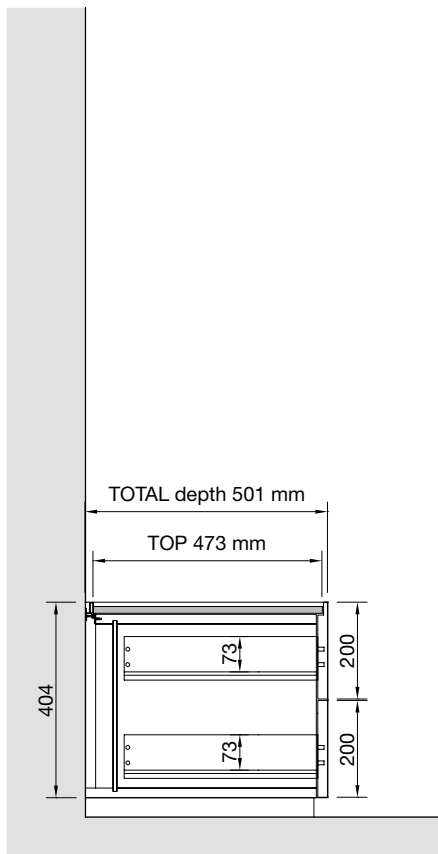

Storage unit with drawer and flap door

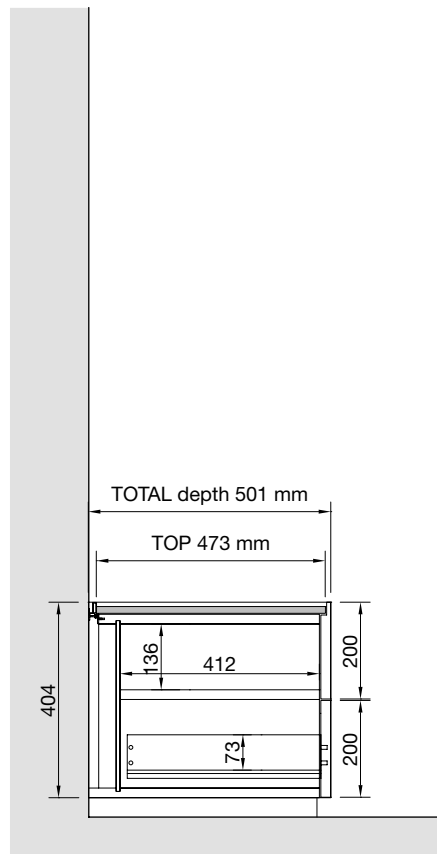

Floorstanding storage units

Storage unit with 2 drawers

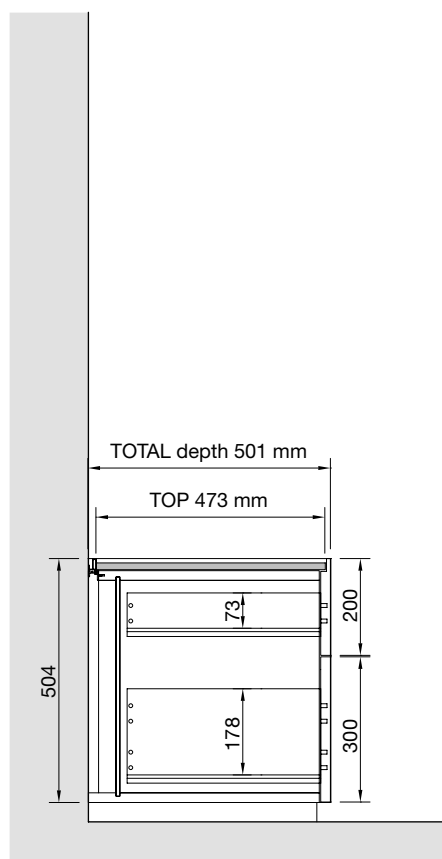

Storage unit with drawer and flap door

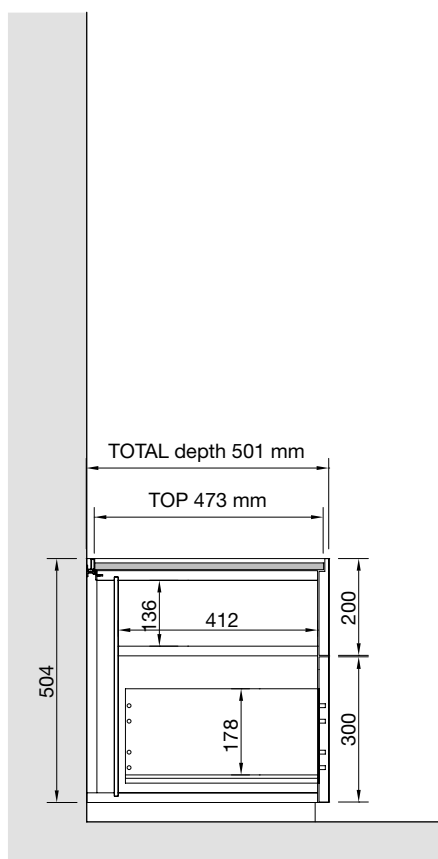

Storage unit with 3 drawers

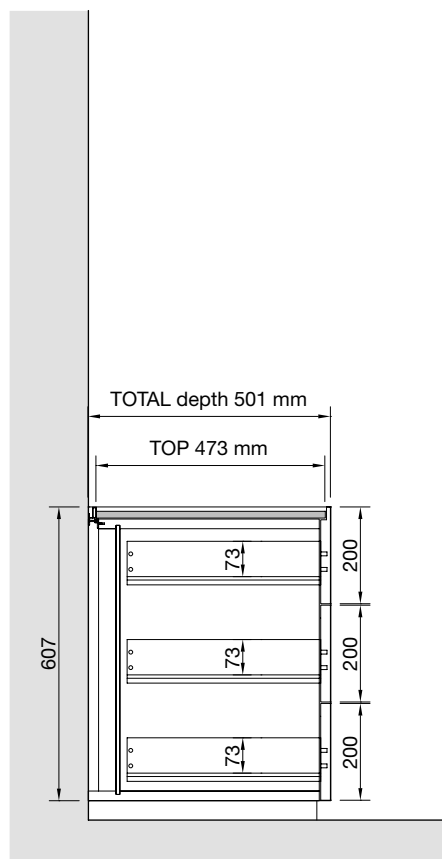

Storage unit with leaf door

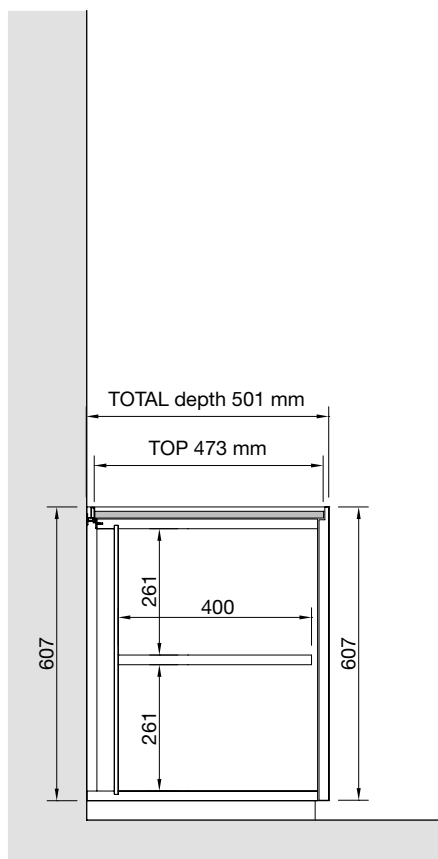

Suspended storage units

Storage unit with drawer

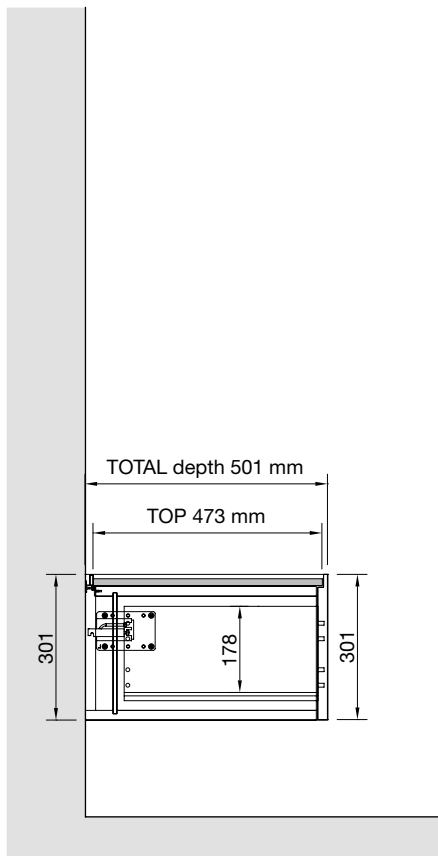

Storage unit with flap door

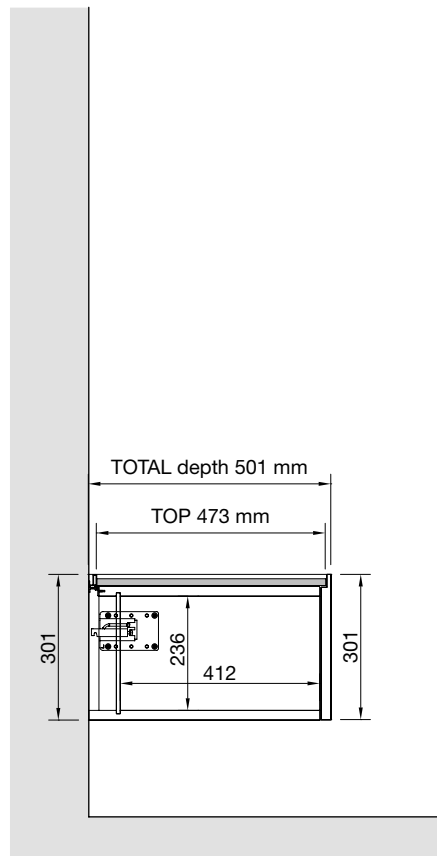

Storage unit with 2 drawers

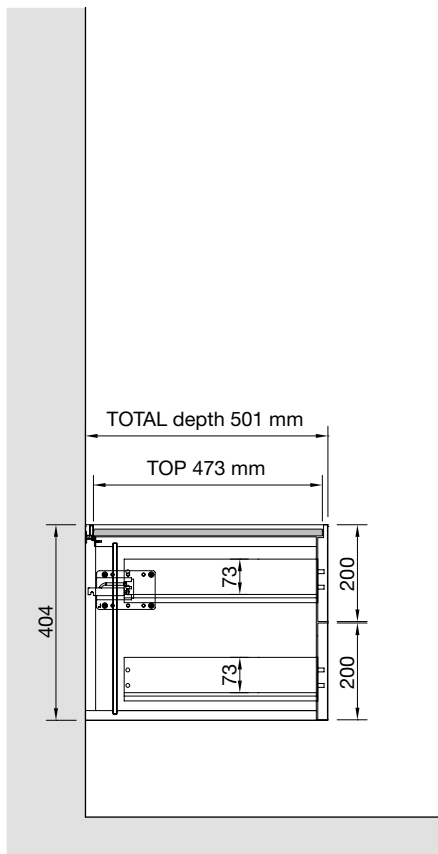

Storage unit with drawer and flap door

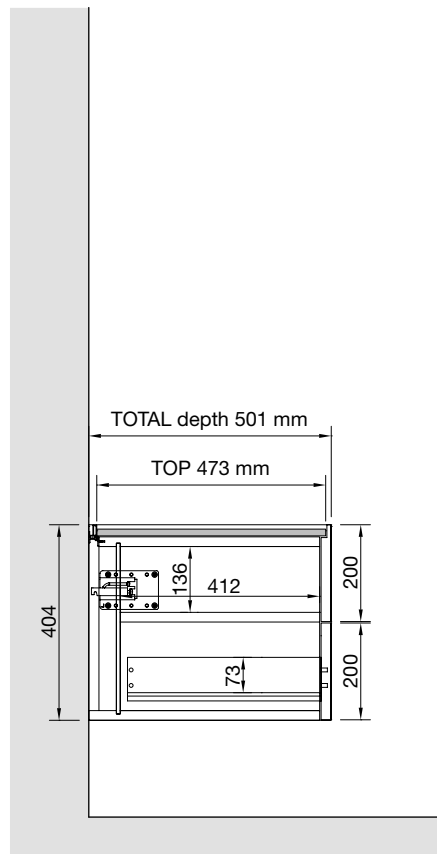

Suspended storage units

Storage unit with 2 drawers

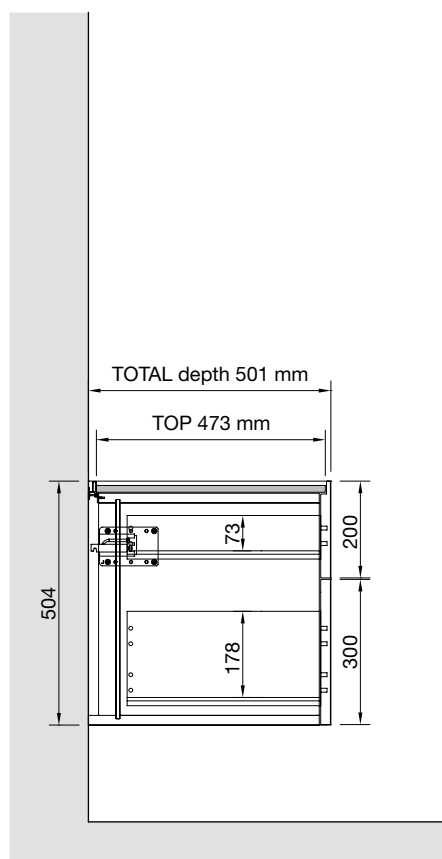

Storage unit with drawer and flap door

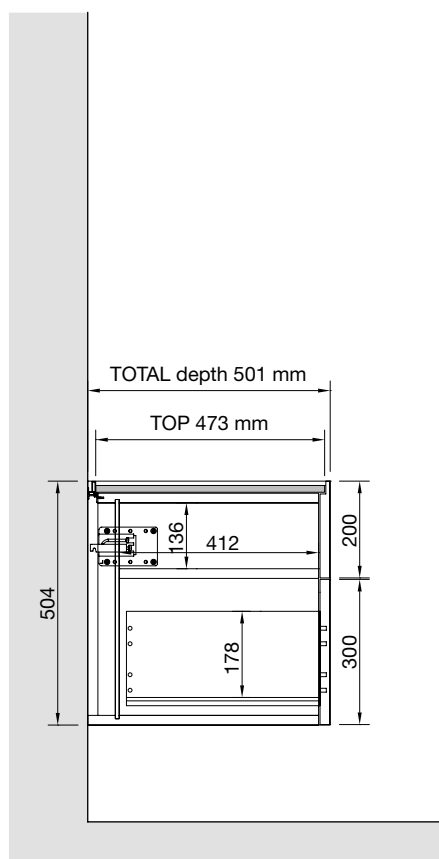

Coplanar

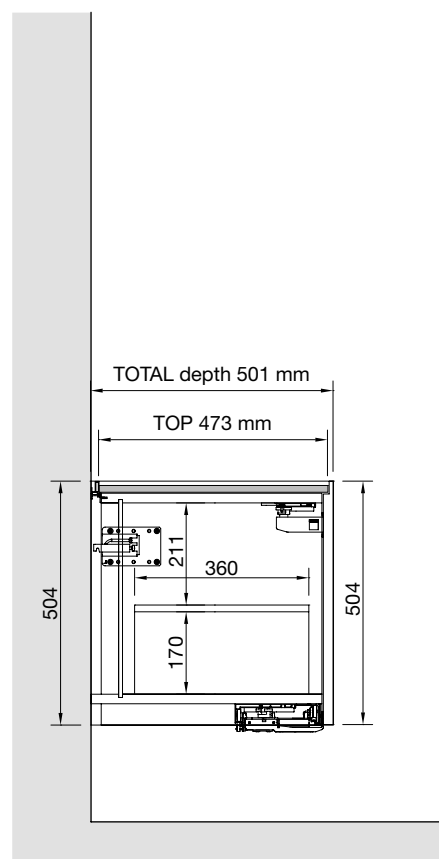

Storage unit with 3 drawers

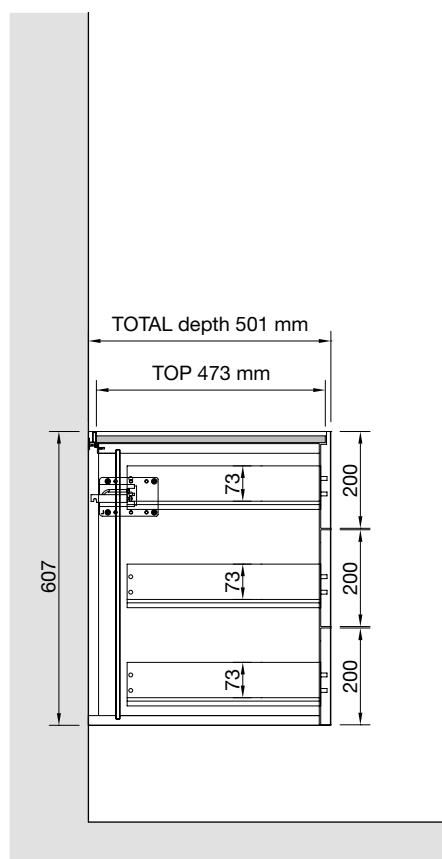

Storage unit with leaf door

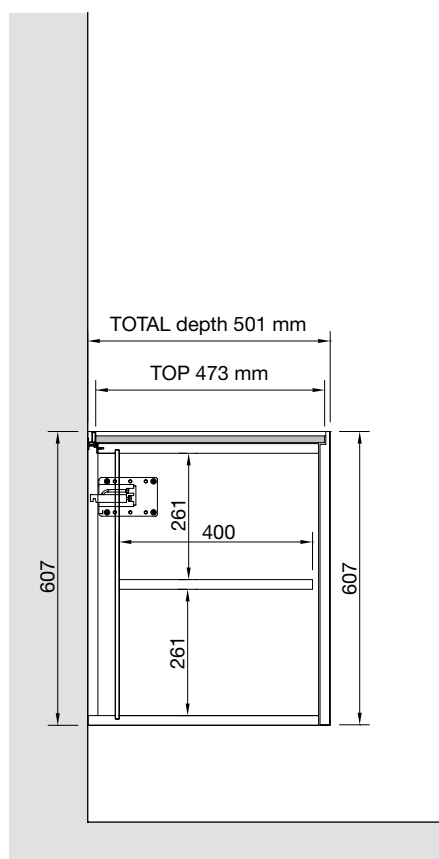

Coplanar

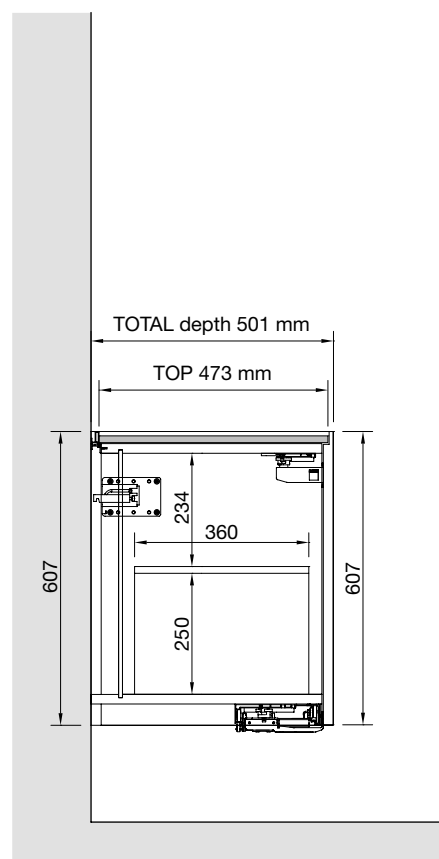

Floorstanding open storage units

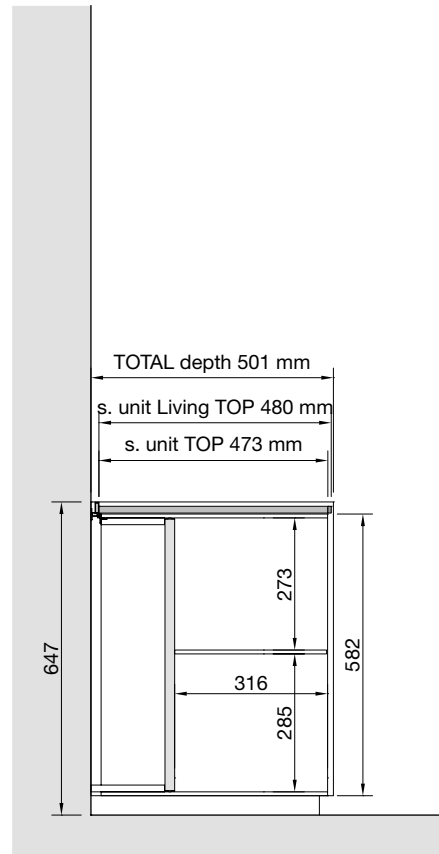
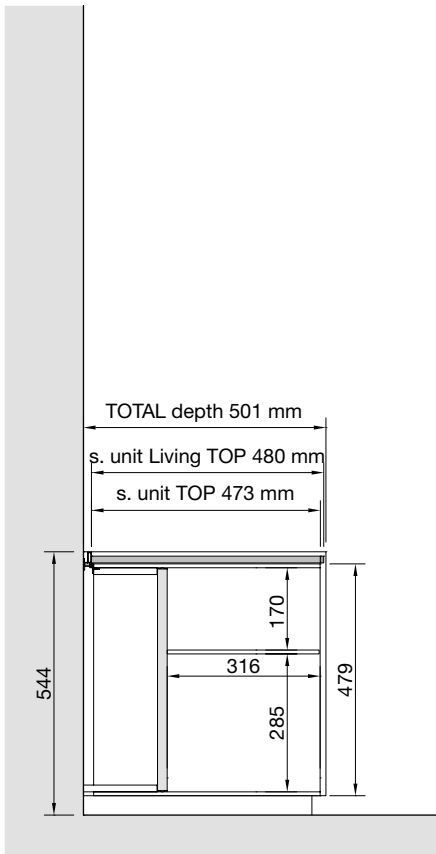
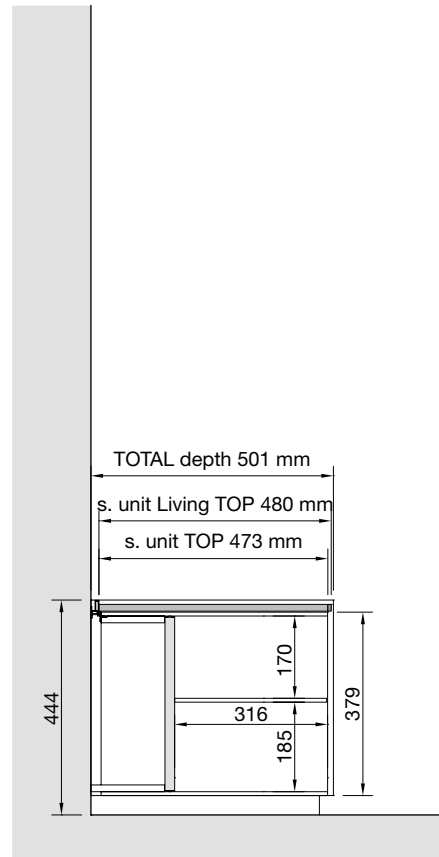
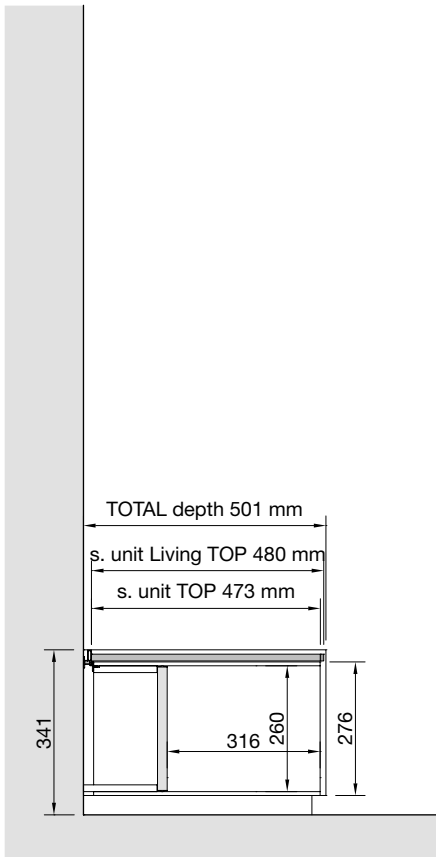

Suspended open storage units

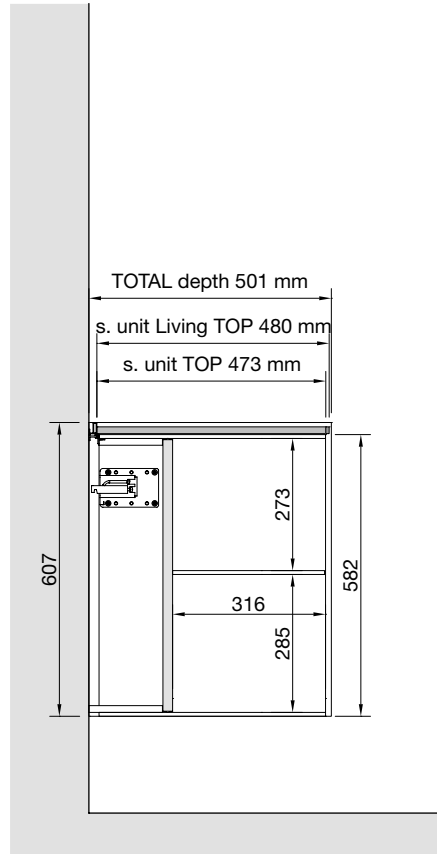
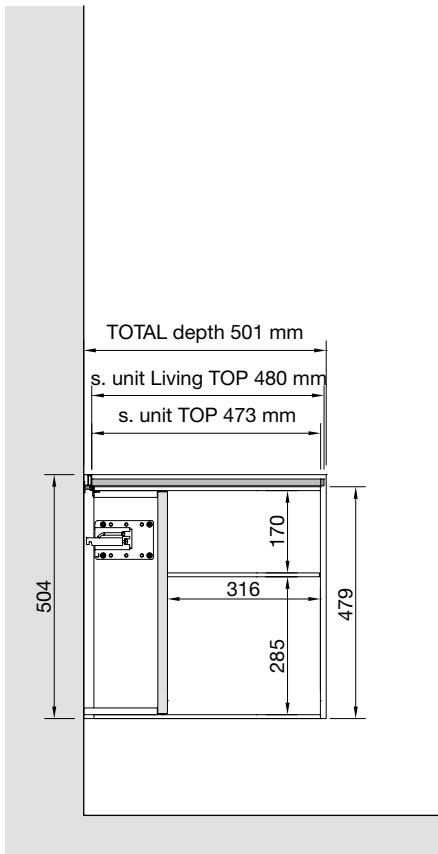
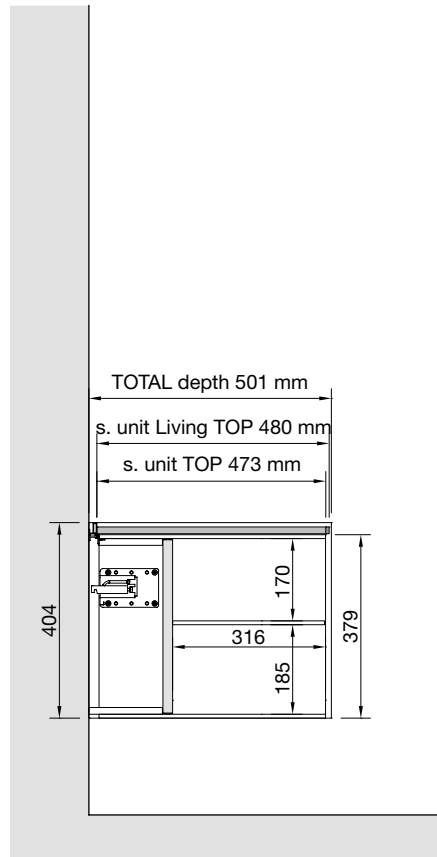
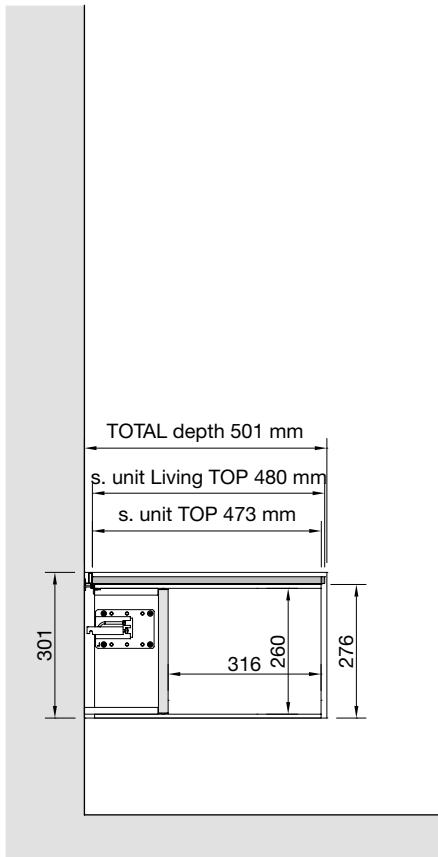

Floorstanding open storage units h 203

Open compartment on storage units with drawer

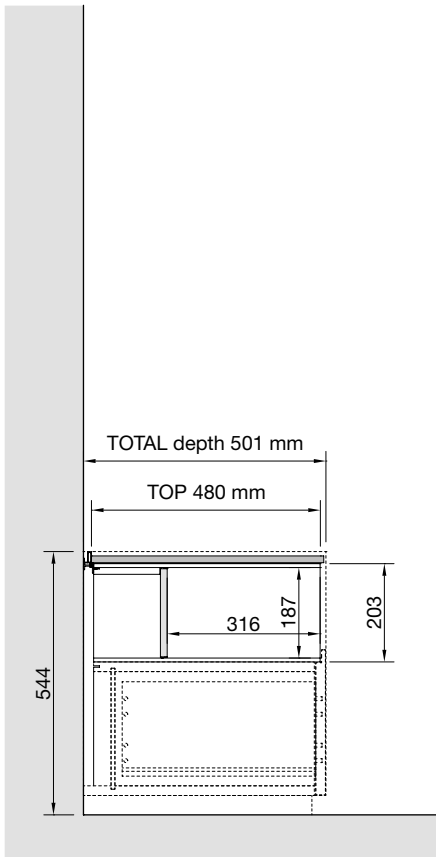

Open compartment on storage units with flap door

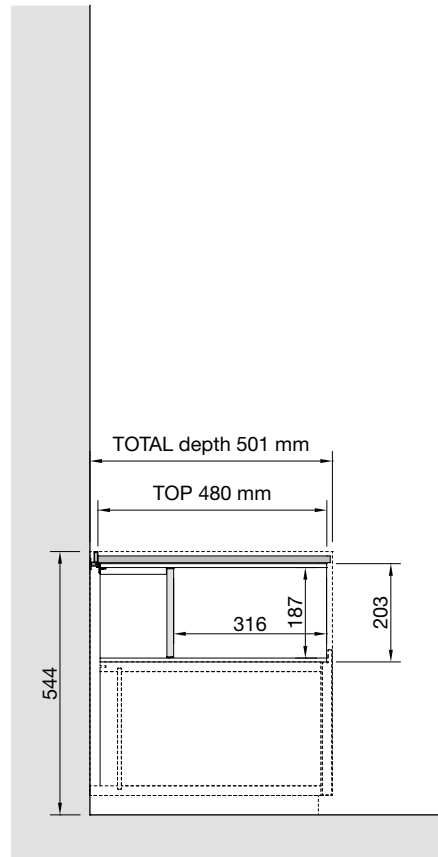

Open compartment on storage units with 2 drawers

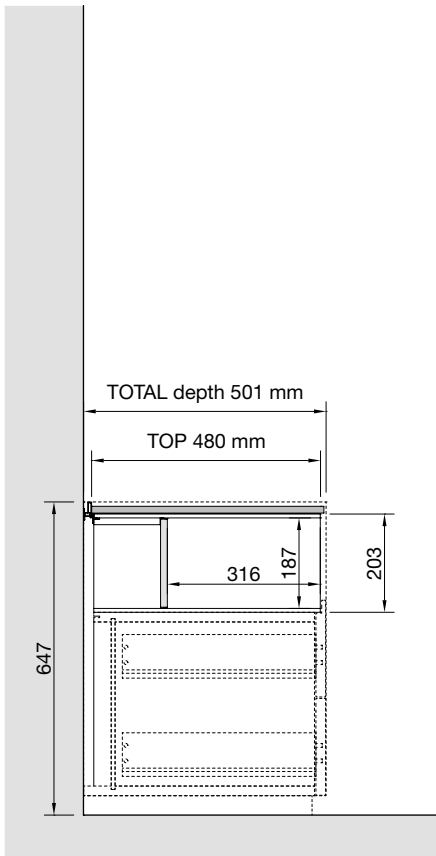

Open compartment on storage units with drawer and flap door

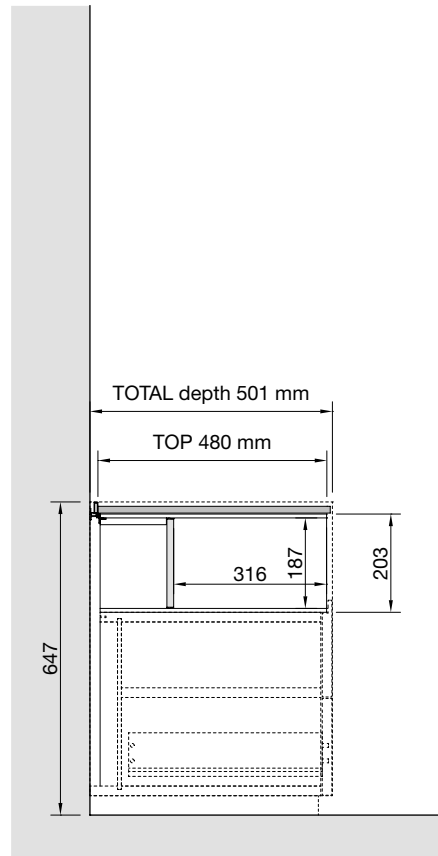

Suspended open storage units h 203

Open compartment on storage units with drawer

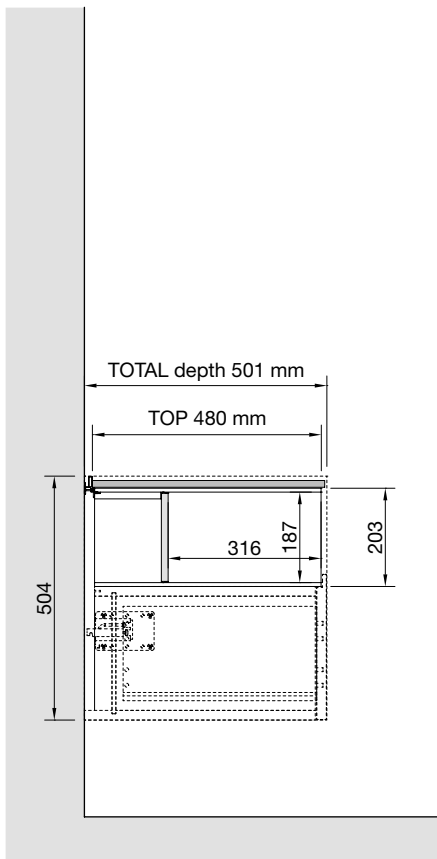

Open compartment on storage units with flap door

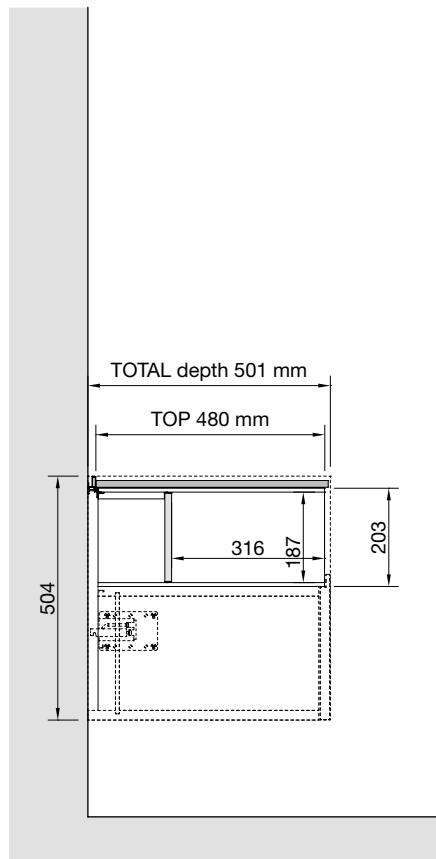

Open compartment on storage units with 2 drawers

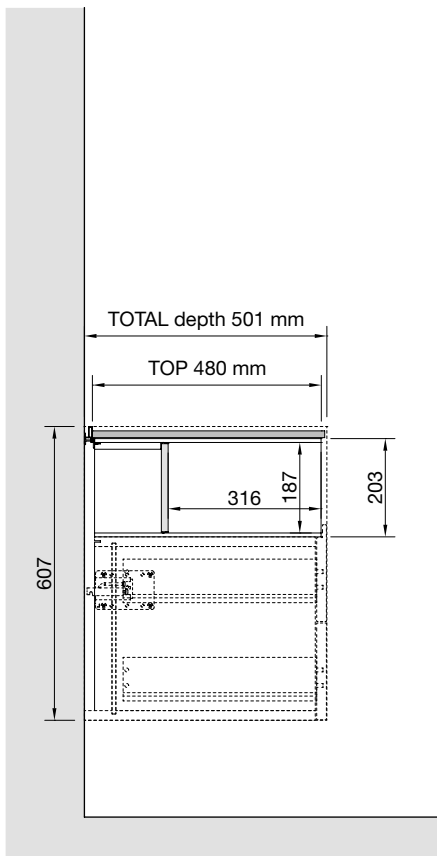

Open compartment on storage units with drawer and flap door

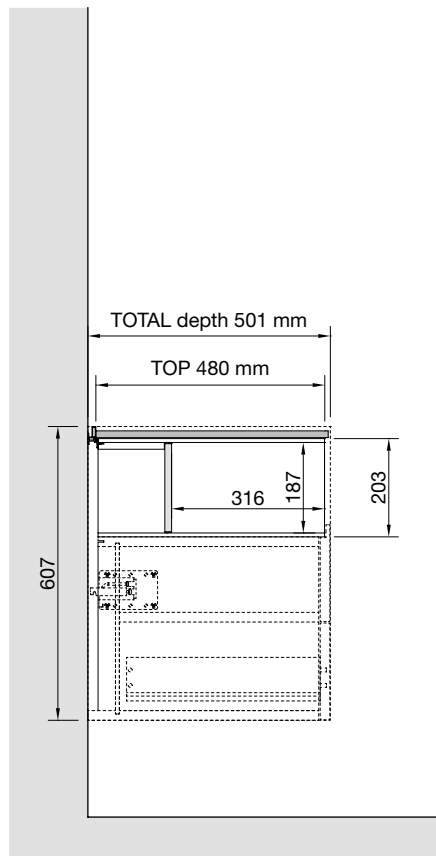

Floorstanding storage units Living

Storage unit with leaf door

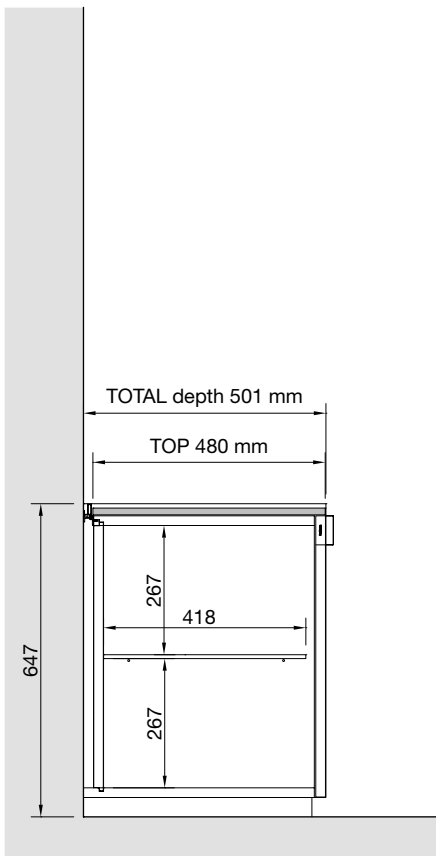

Storage unit with 3 drawers

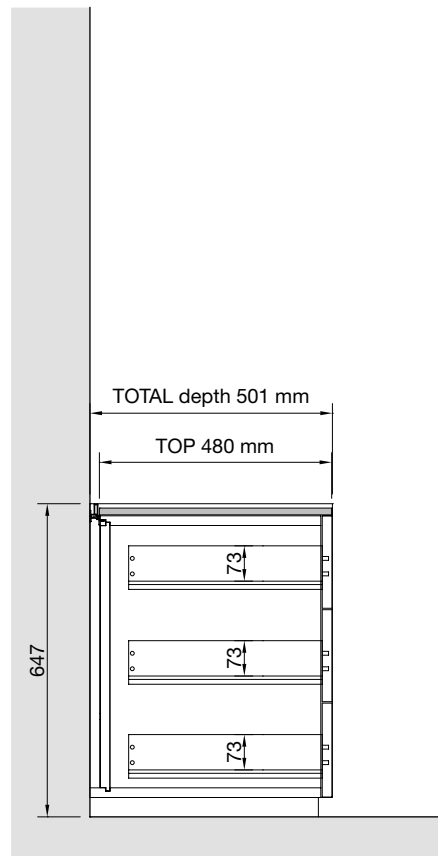

Storage unit with leaf door
inner chest of drawers

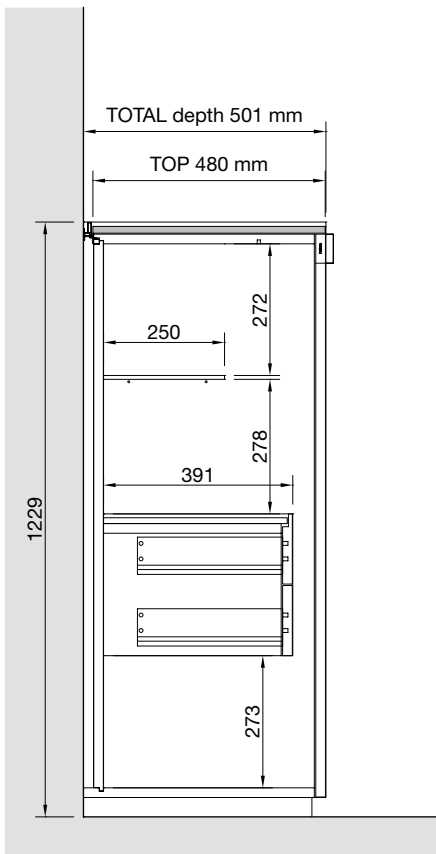

Storage unit with leaf door

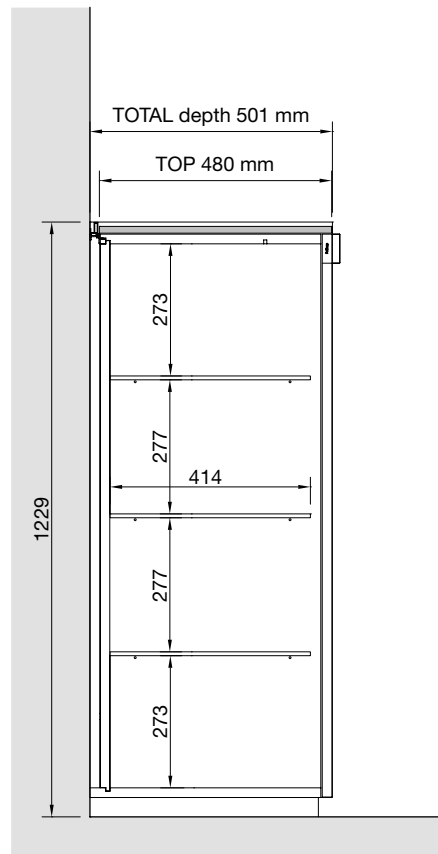

Suspended storage units Living

Storage unit with leaf door

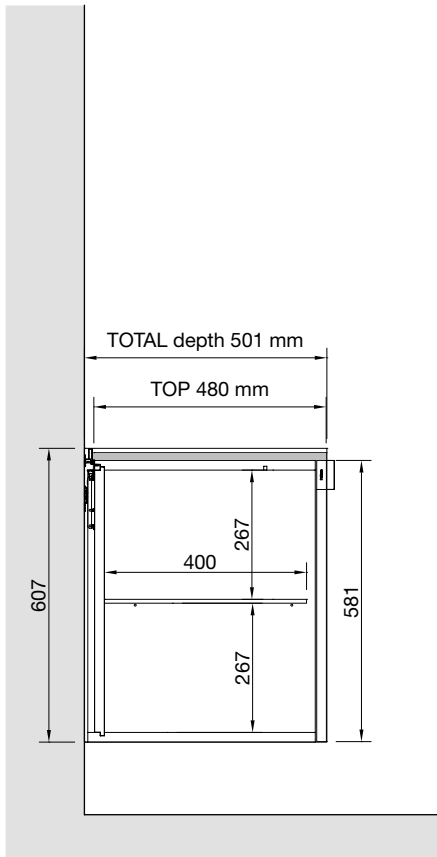

Storage unit with 3 drawers

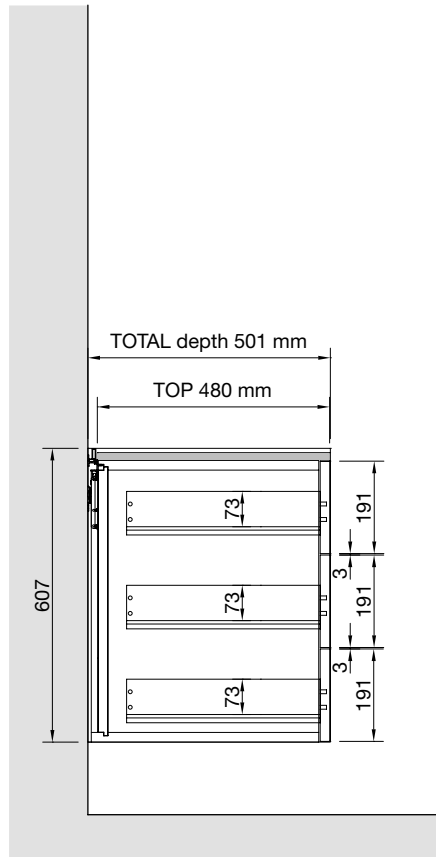

Storage unit with leaf door
inner chest of drawers

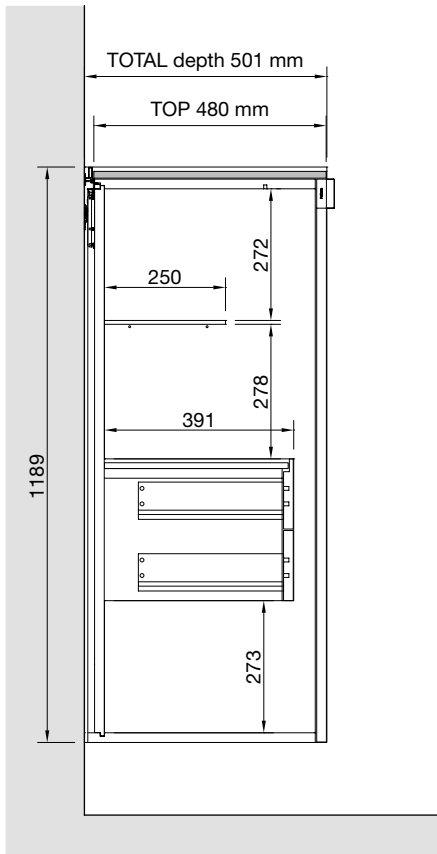

Storage unit with leaf door

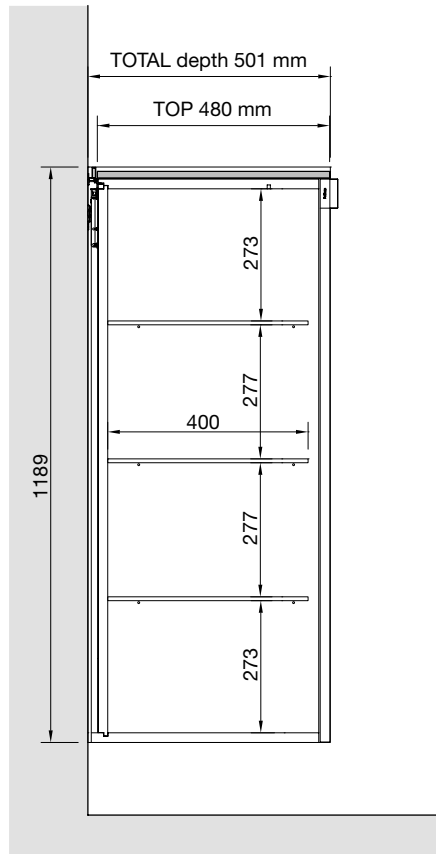

Floorstanding open storage units Living

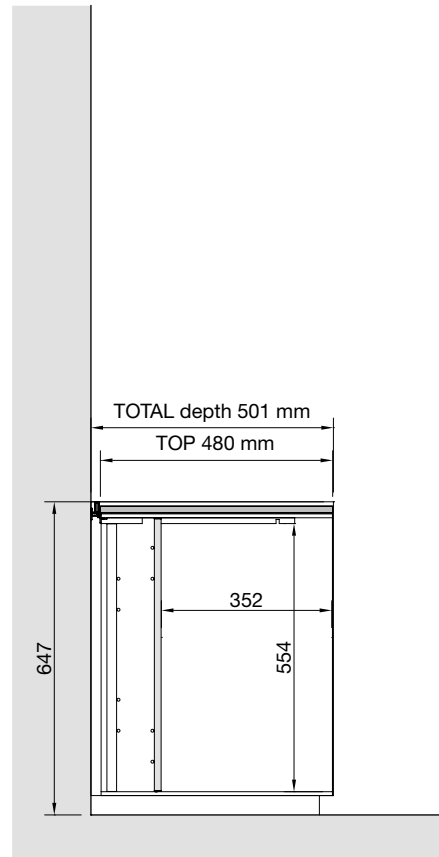
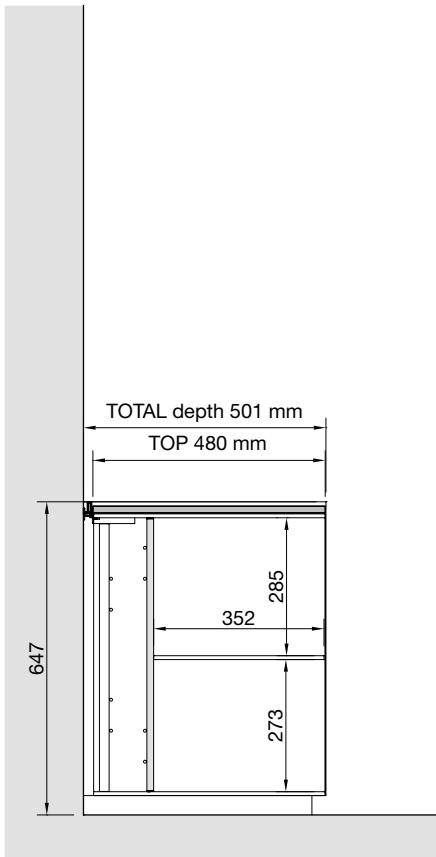

Floorstanding open storage units Living

Version A

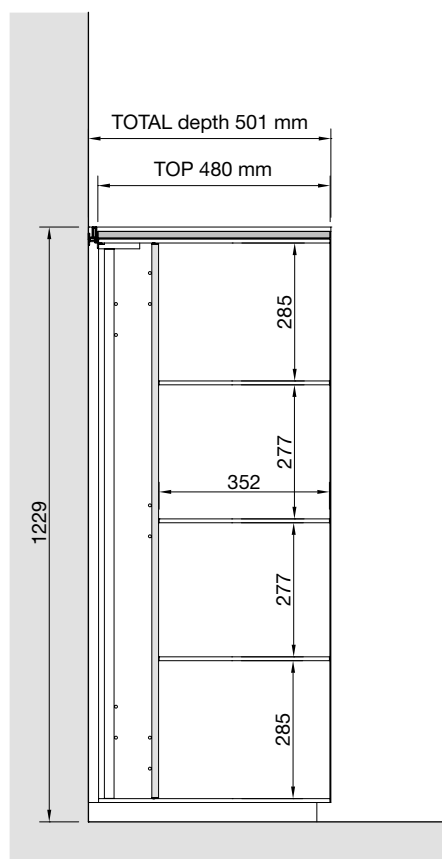

Version B

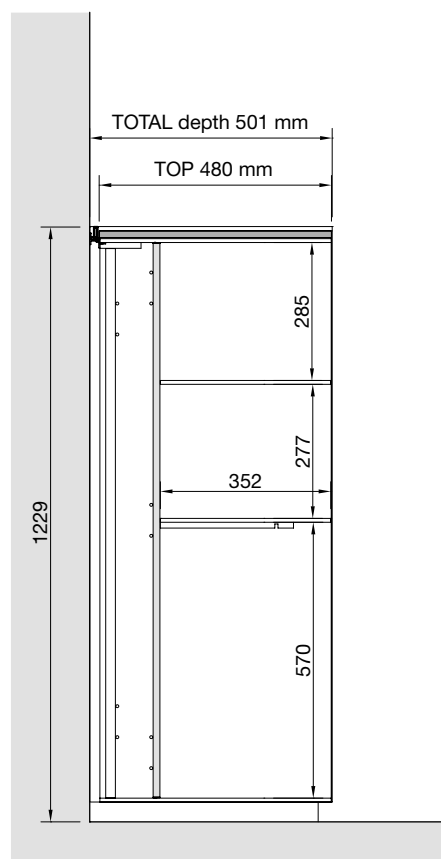

Version C

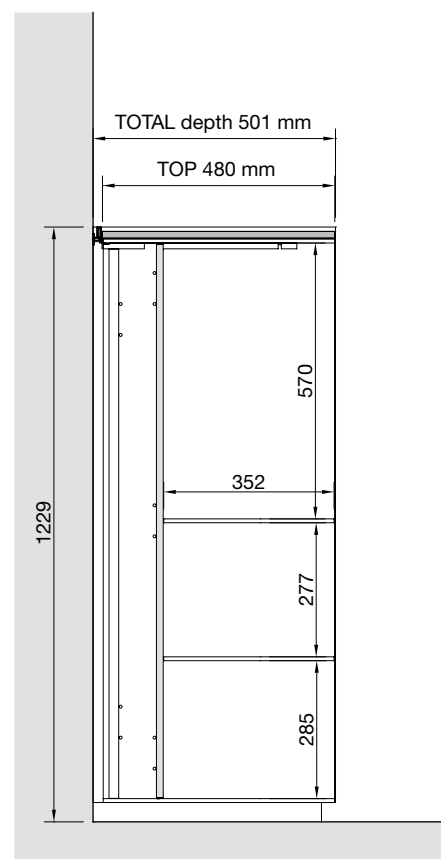

Version D

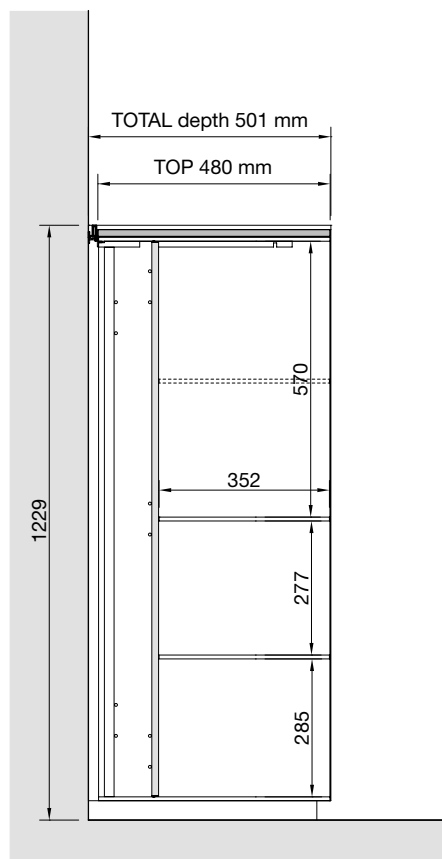

Version E

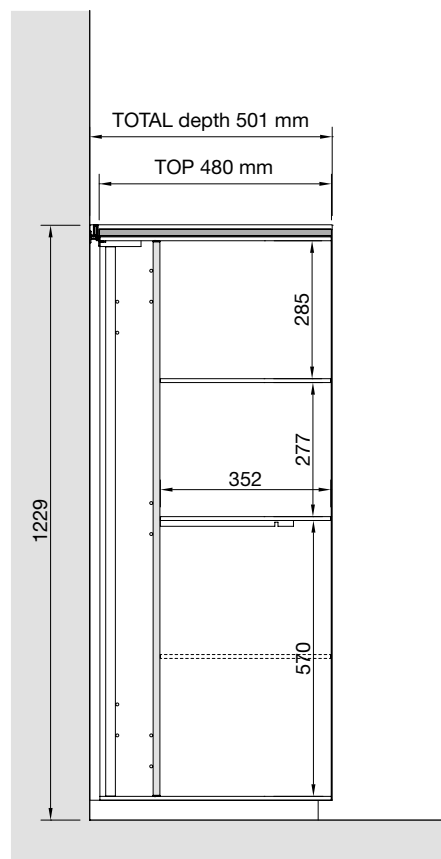

Version F

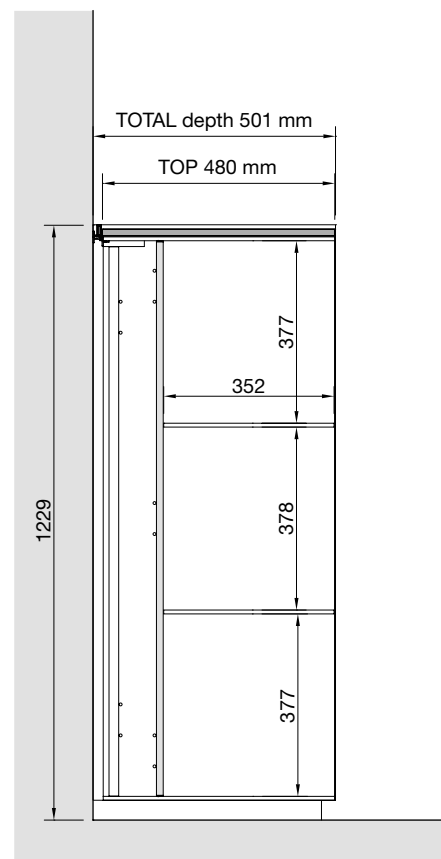

Suspended open storage units Living

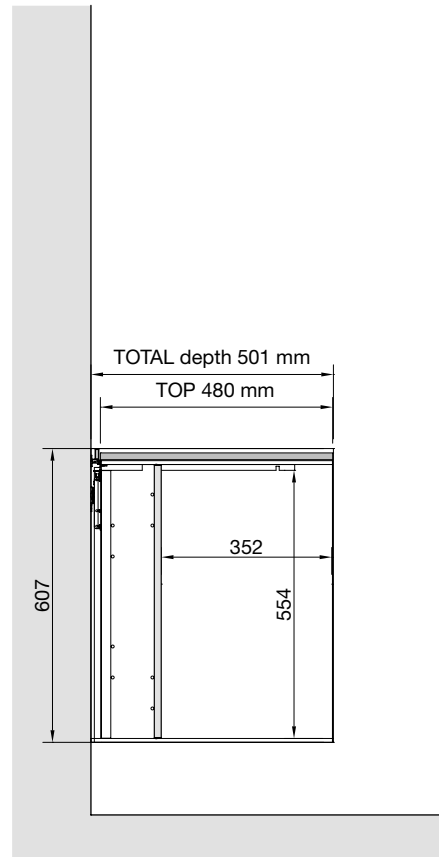
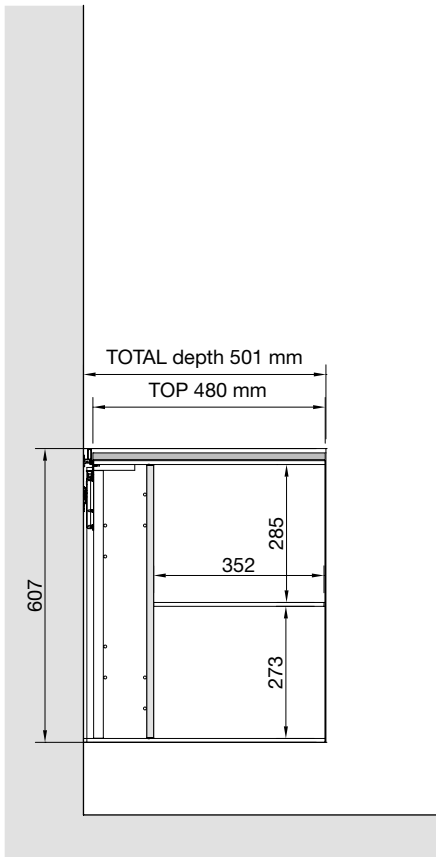

Suspended open storage units Living

Version A

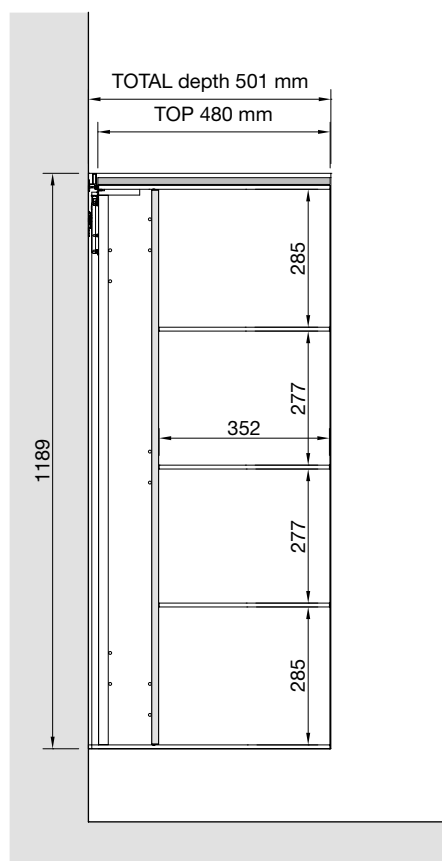

Version B

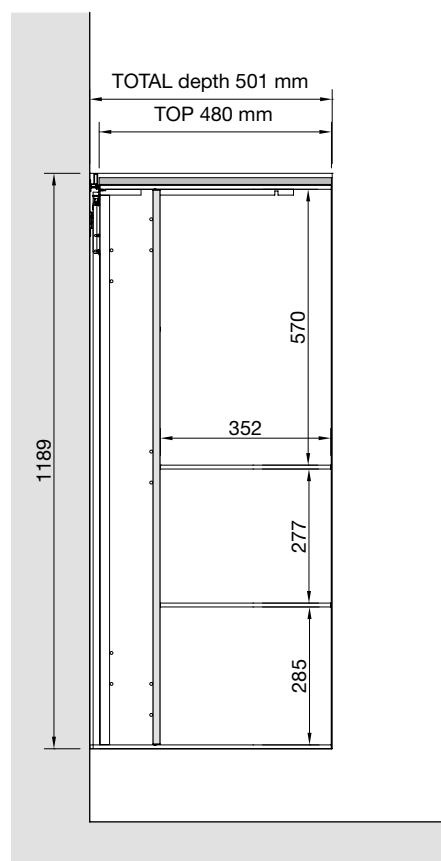

Version C

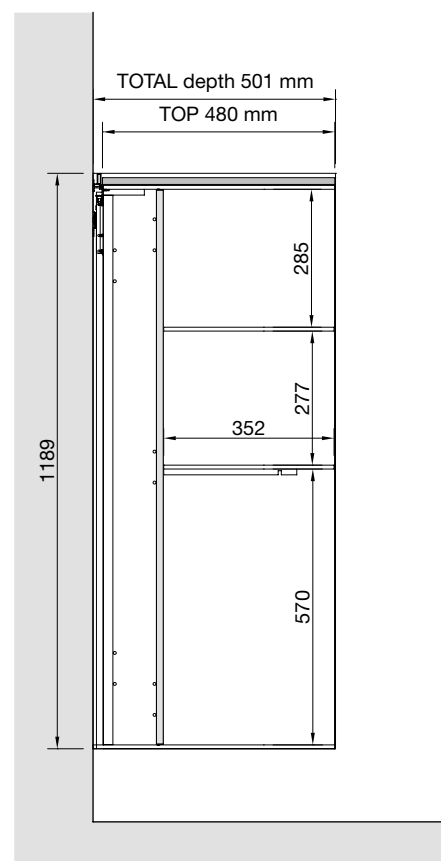

Version D

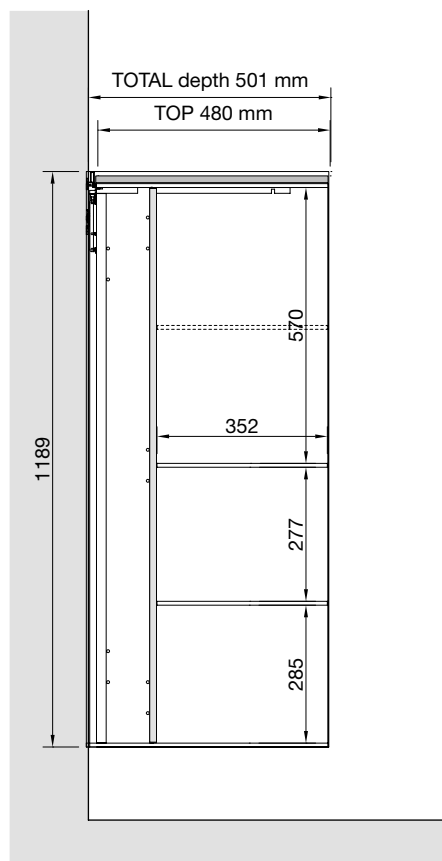

Version E

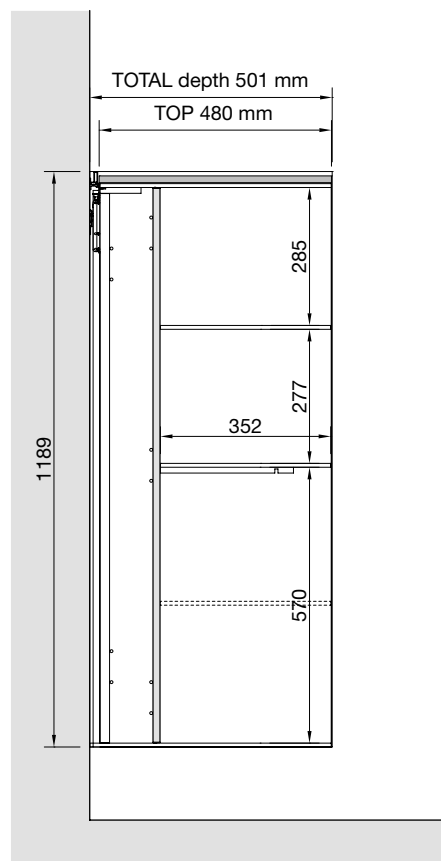

Version F

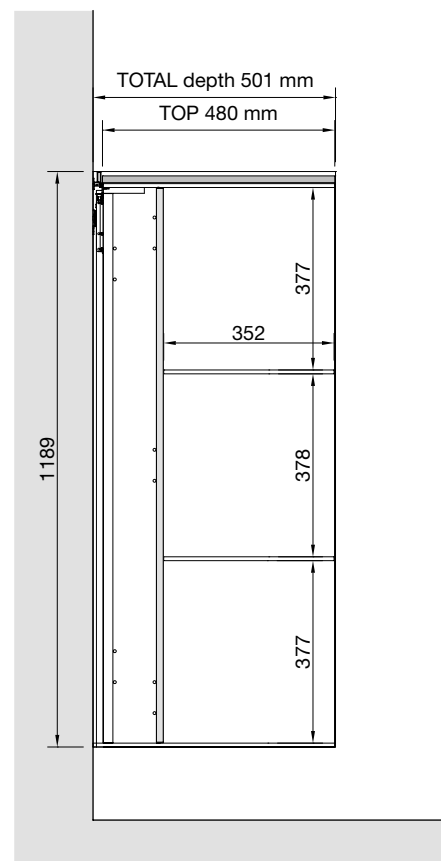

TV-portal

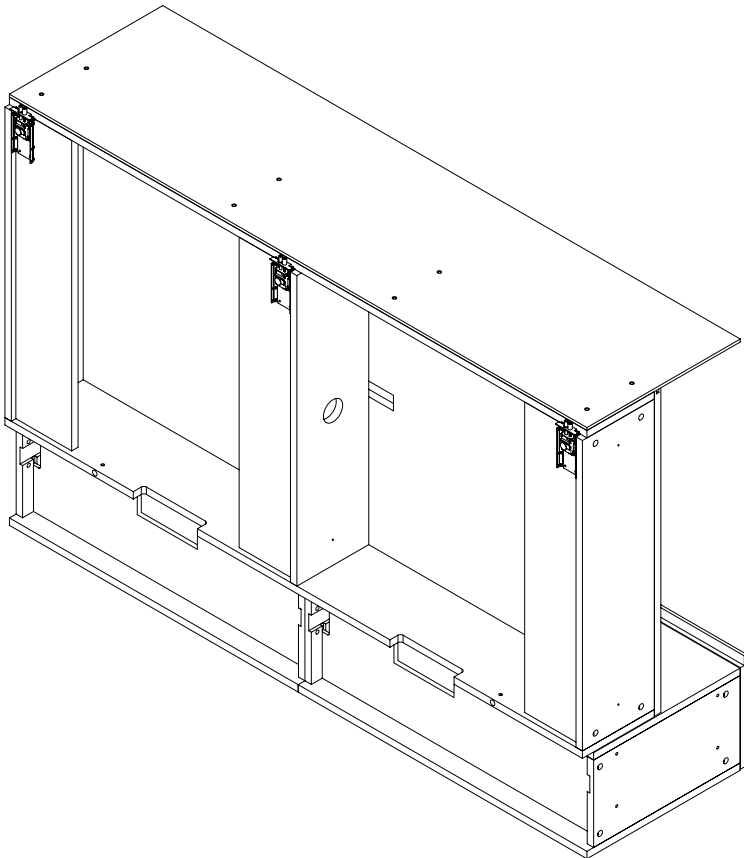
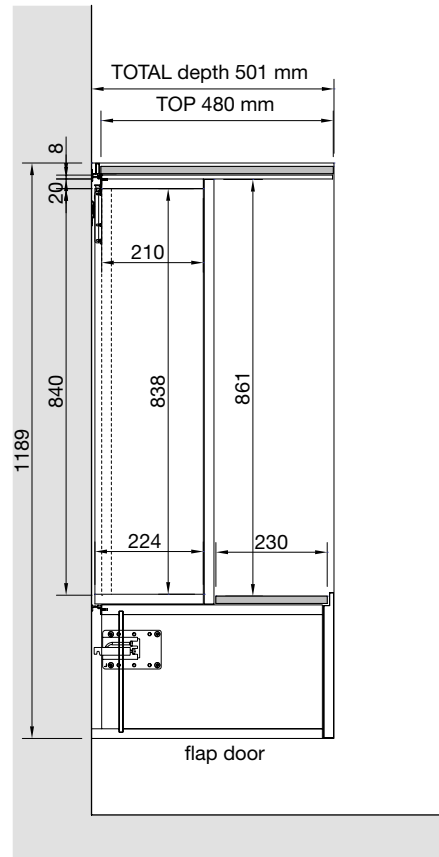
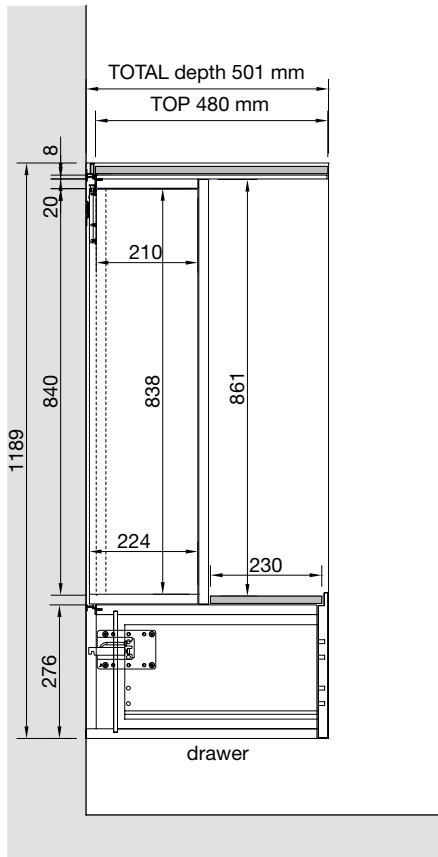

Hanging storage units

Wooden door

wooden shelves th 20 mm

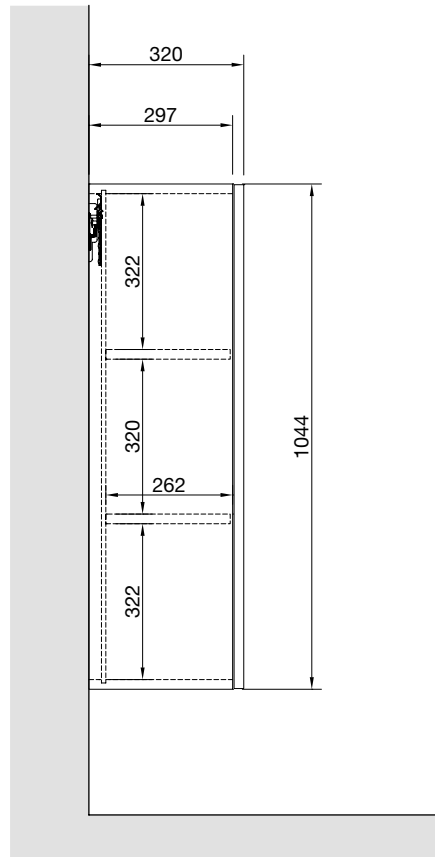
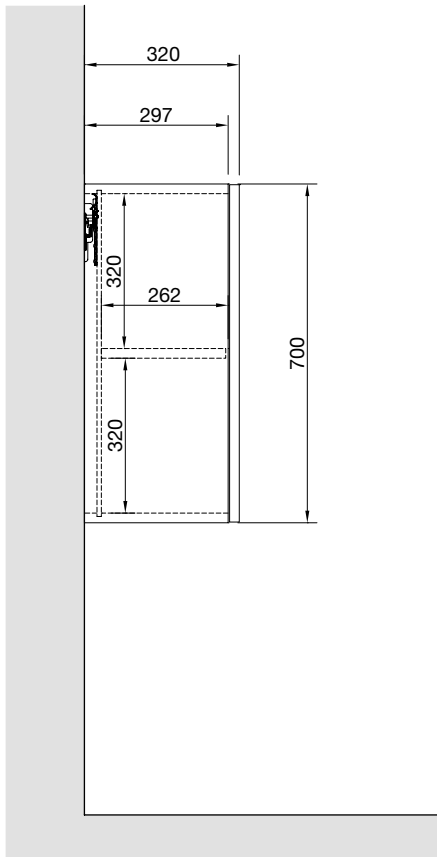

Glass door

glass shelves th 8 mm

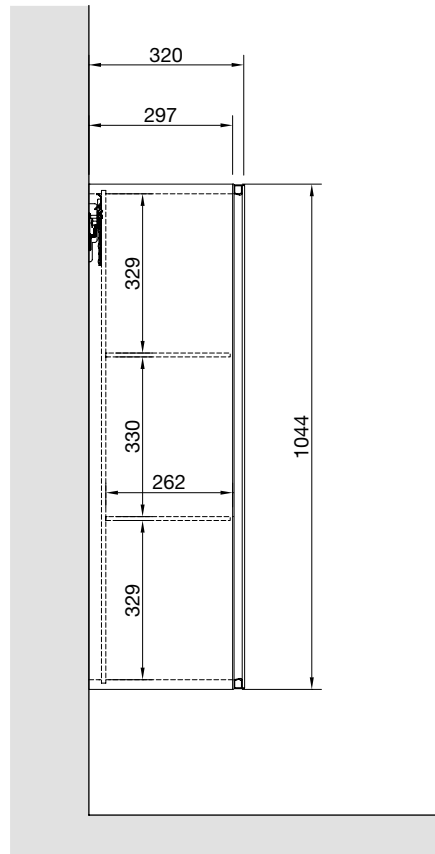
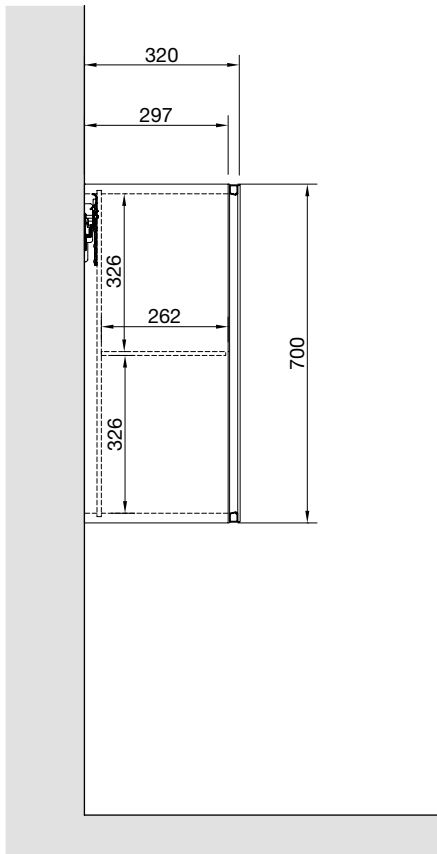

Bookshelves

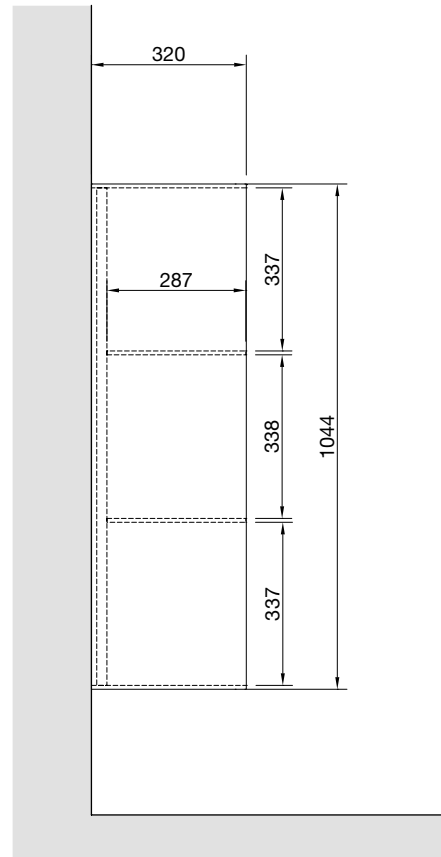
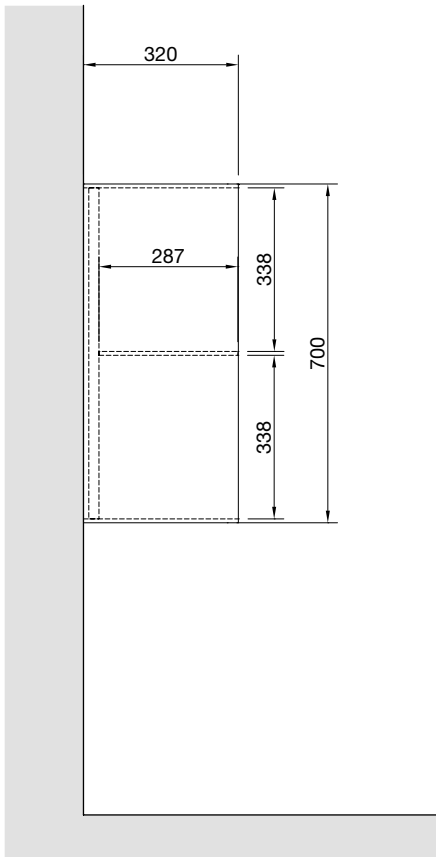

Shelf

For wall fixing
thickness 8 mm

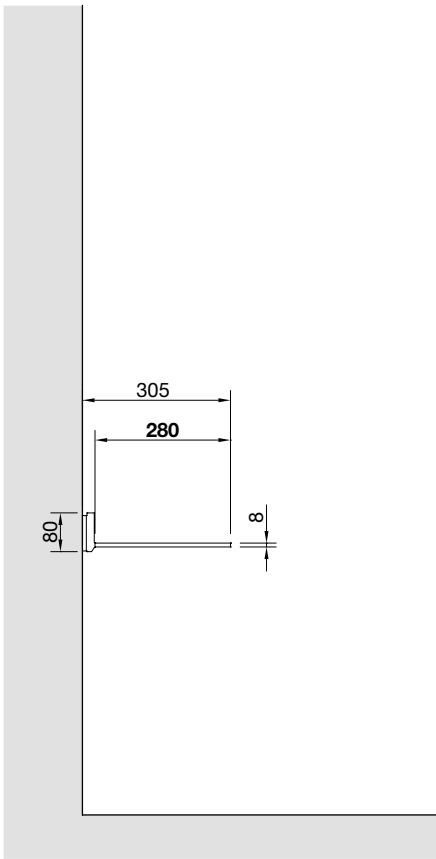

For wall fixing with light
thickness 8 mm

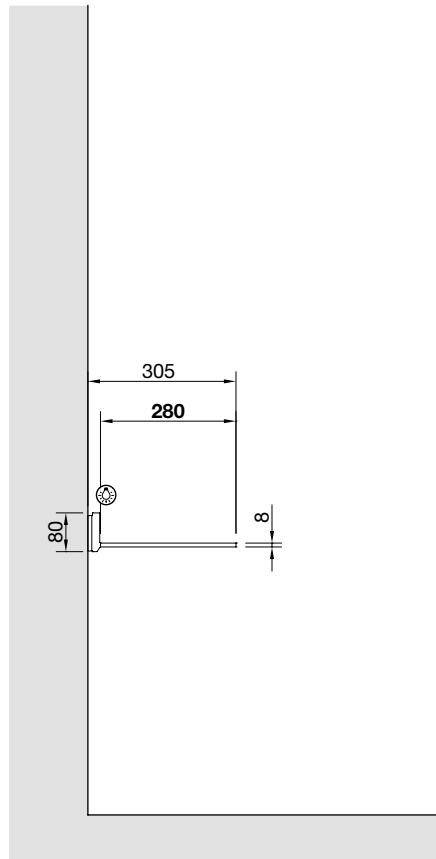

For SURFACE wall panelling
thickness 8 mm

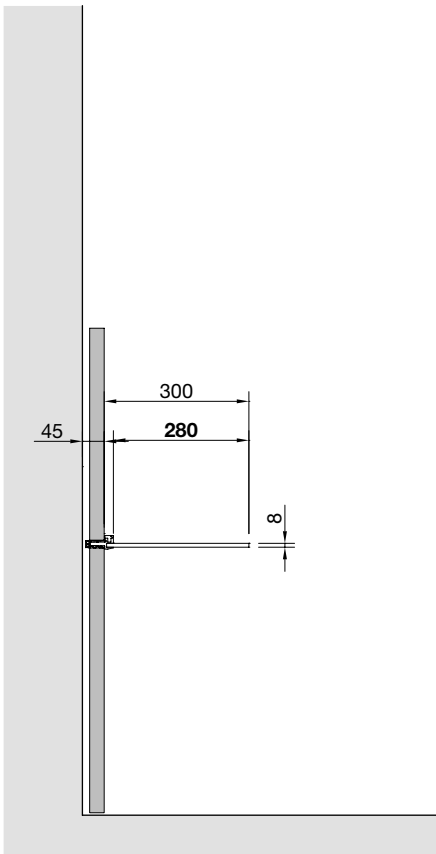

For SURFACE wall panelling with light
thickness 8 mm

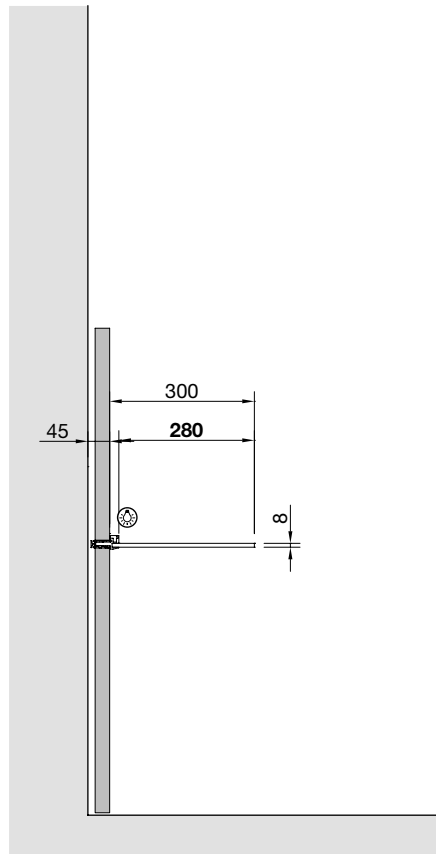

Hanging thick shelf

Note:

Suggested height 730 mm for desk use

For wall fixing

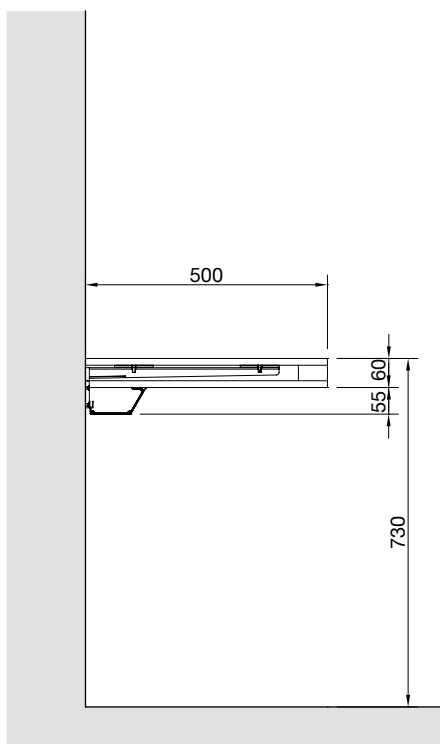

**For wall fixing
with electrified channel**

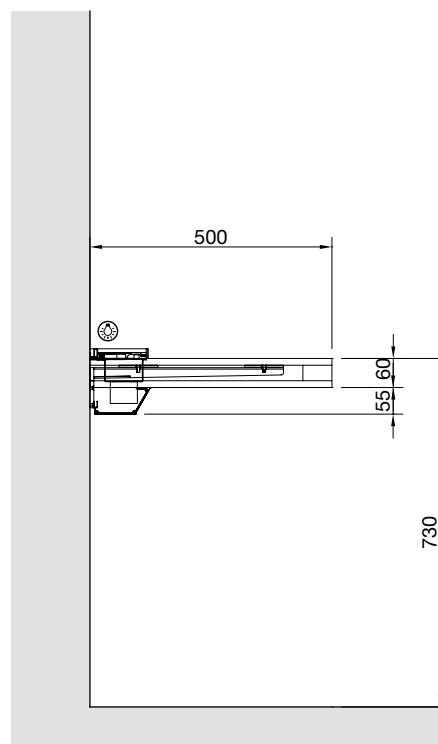

For SURFACE wall panelling

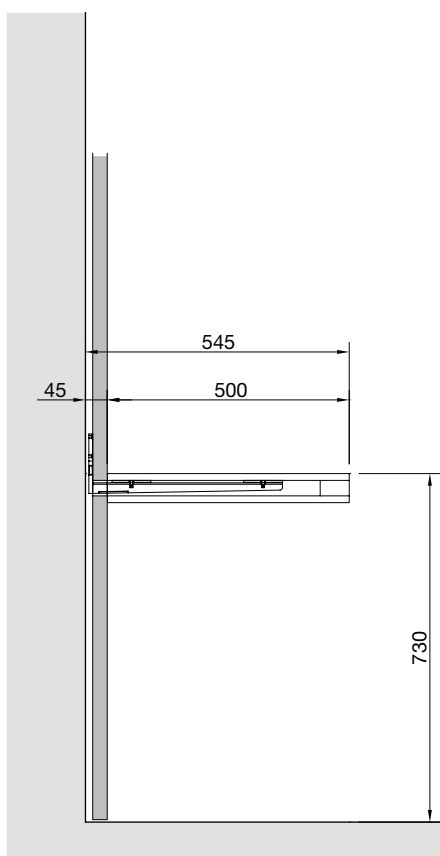

**For SURFACE wall panelling
with electrified channel**

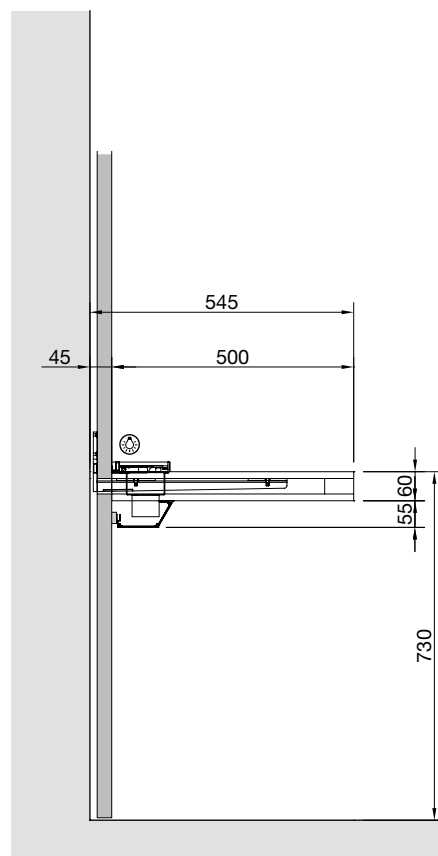

Finishing top

Wood
thickness 14 mm with spacers

Storage units

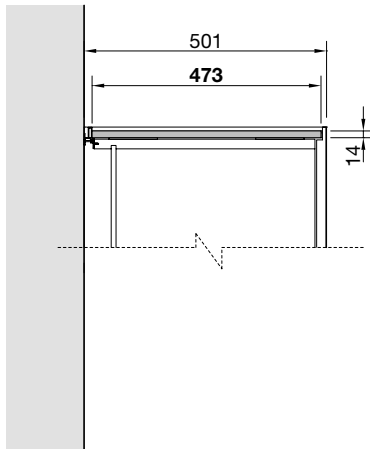

Marble
thickness 18 mm with profile

Storage units

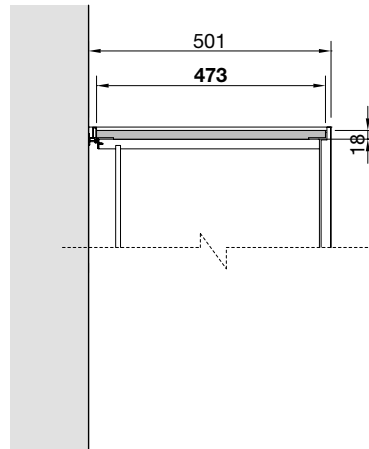

Open storage units

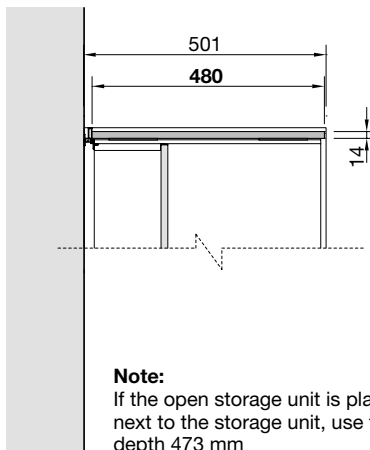

Open storage units

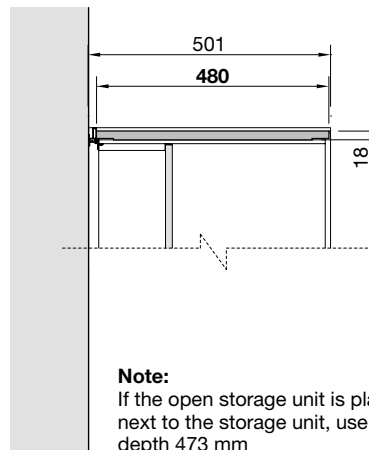

Storage units Living - Open storage units Living

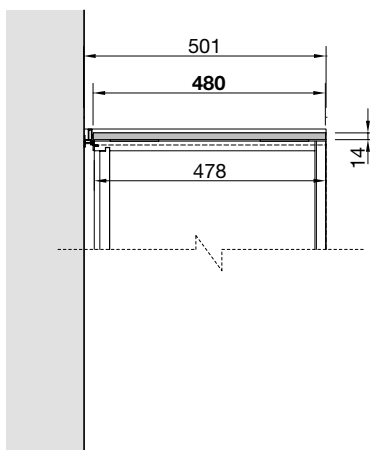

Storage units Living - Open storage units Living

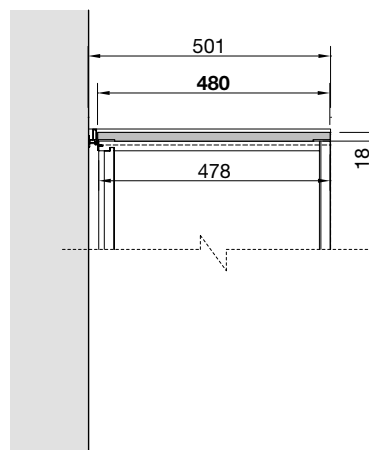

Finishing top

Wood
thickness 14 mm with spacers

TV-portal

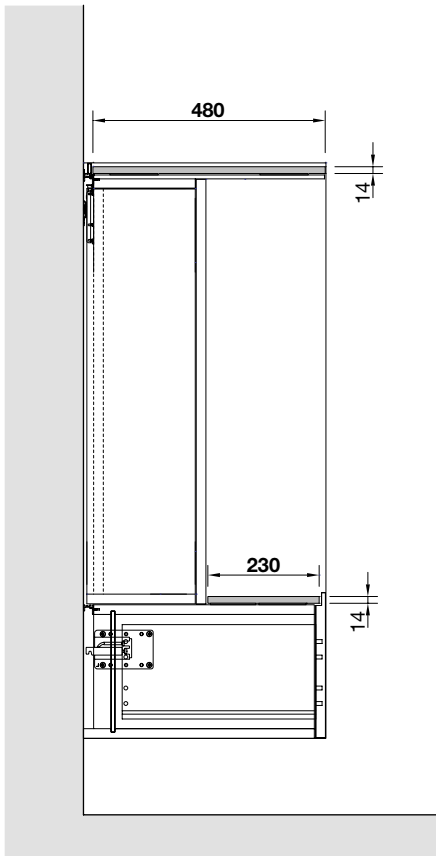

Finishing top - construction rules

Storage units

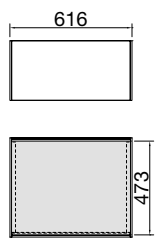

Open storage unit on storage units + Storage unit

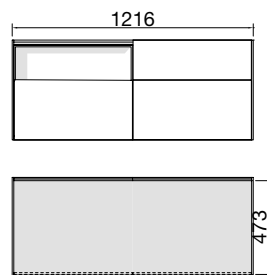

Open storage unit

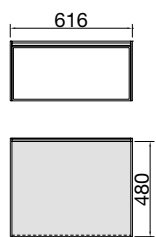

Open storage unit on storage units

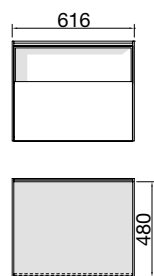

Storage unit + Open storage unit

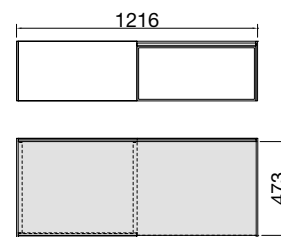

Finishing top - construction rules

Storage units Living

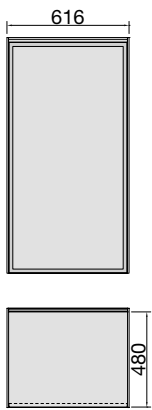

Open storage units Living

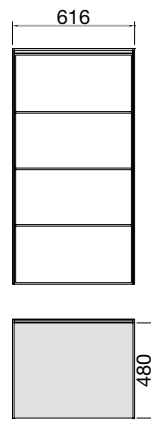

Storage unit Living + Open storage units Living

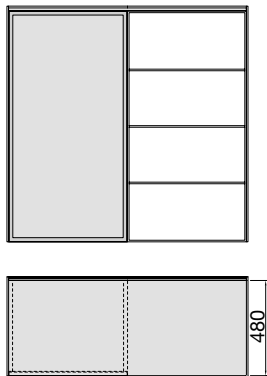

Inner lamps: positioning

Suspended storage units Living

Note:

The positioning of the lamp is the same also for the floorstanding version.

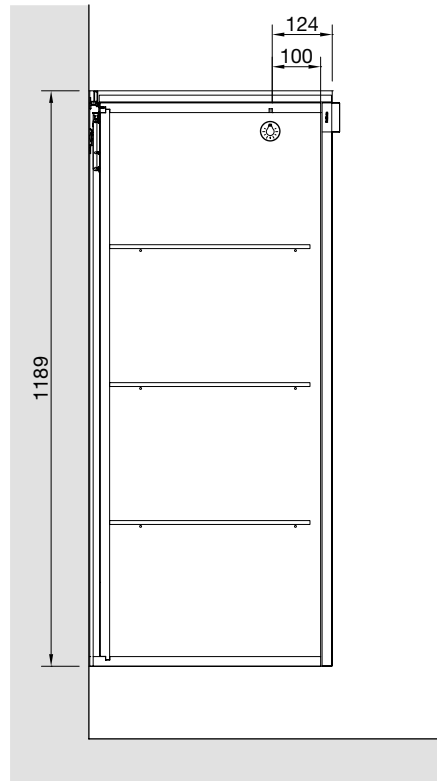
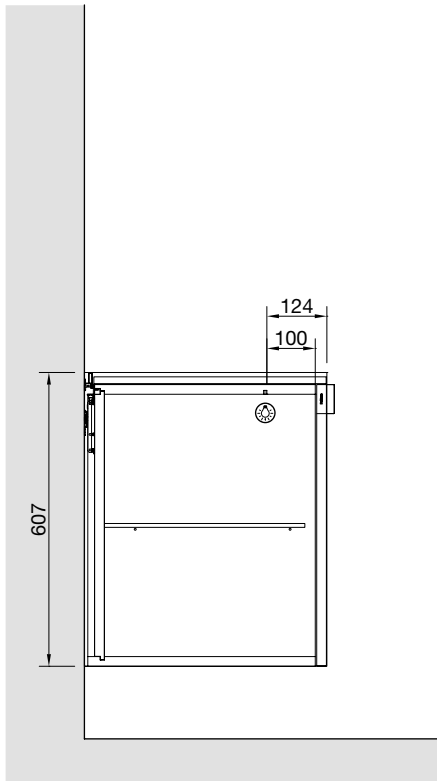

Open storage units Living

Note:

The positioning of the lamp is the same also for the floorstanding version.

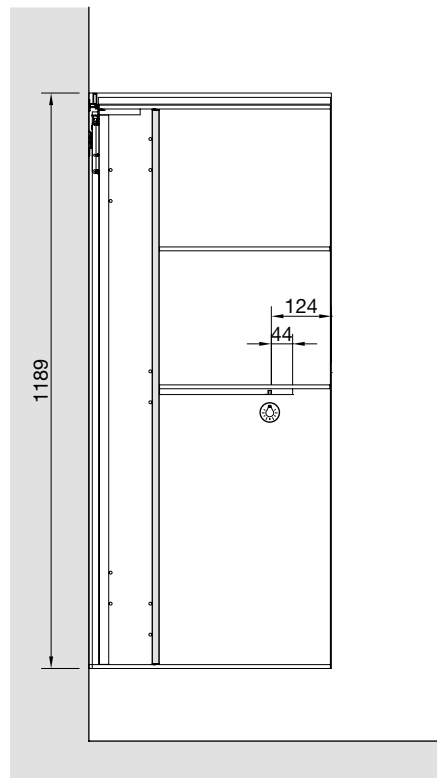
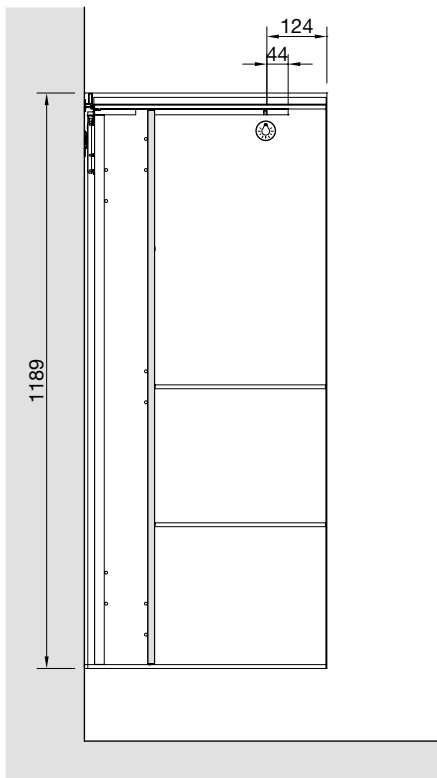

Inner lamps: positioning

Hanging storage units

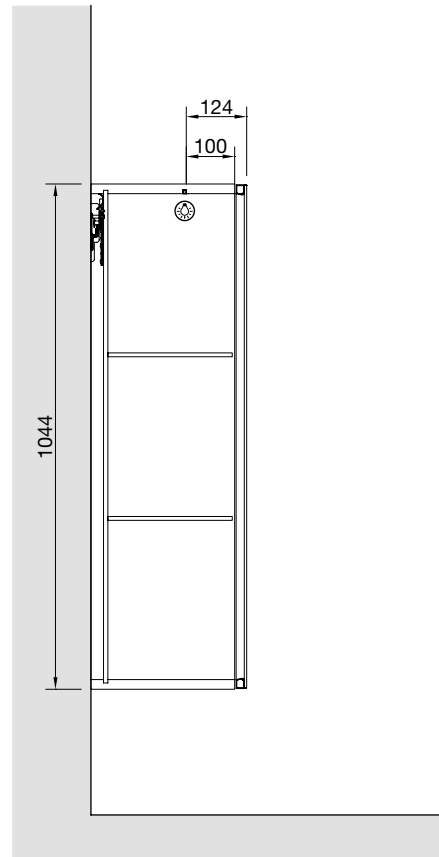
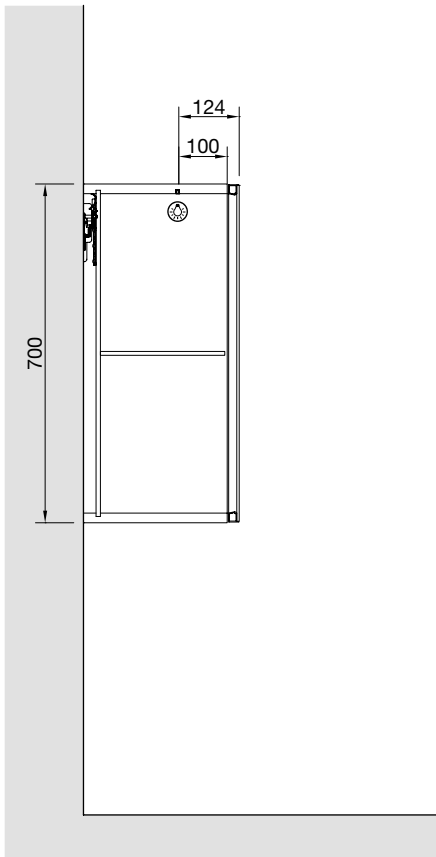

Lamps on storage units profile

Note:

If there are storage units placed side by side, the profile and the lamp will be as long as the composition up to a maximum width of 3000 mm. In case of longer compositions it is necessary to divide the lamp following the finishing top junctions.

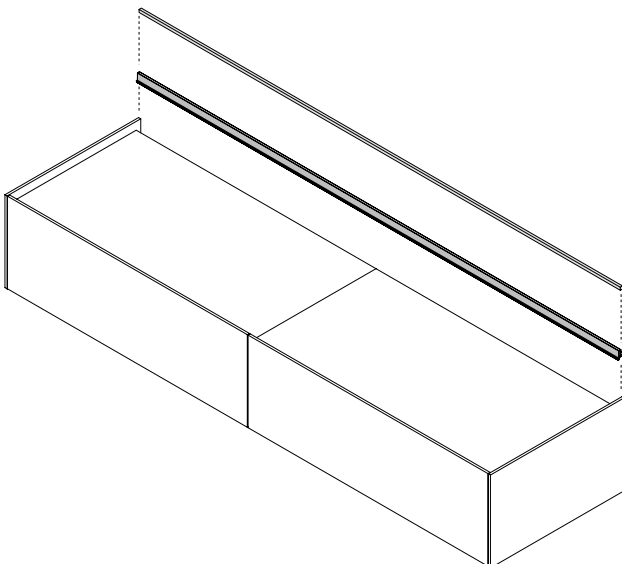

Cables passage

Floorstanding storage unit with leaf door

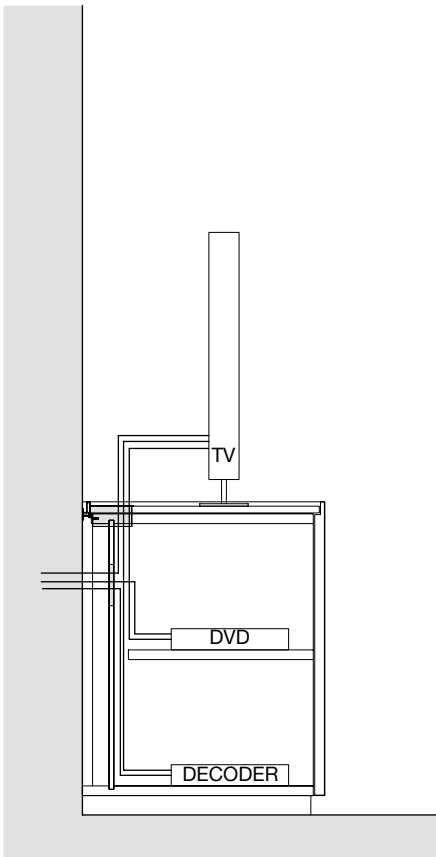

Floorstanding storage unit with flap door

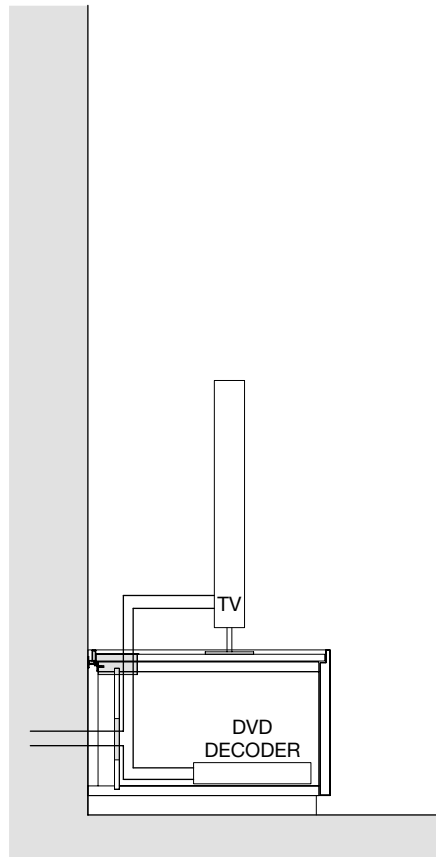

Suspended storage unit with leaf door

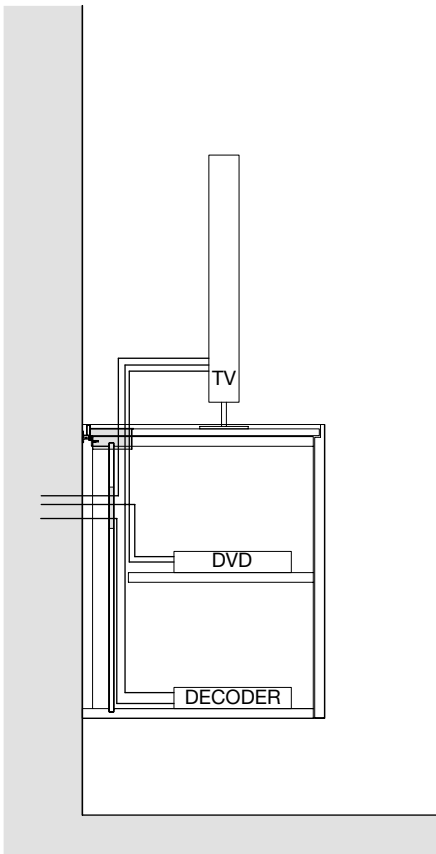

Suspended storage unit with flap door

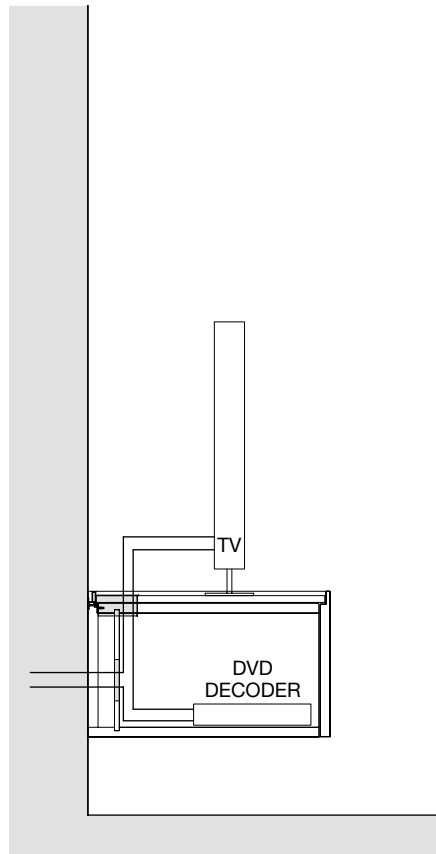

Cables passage

Suspended storage unit with coplanar door

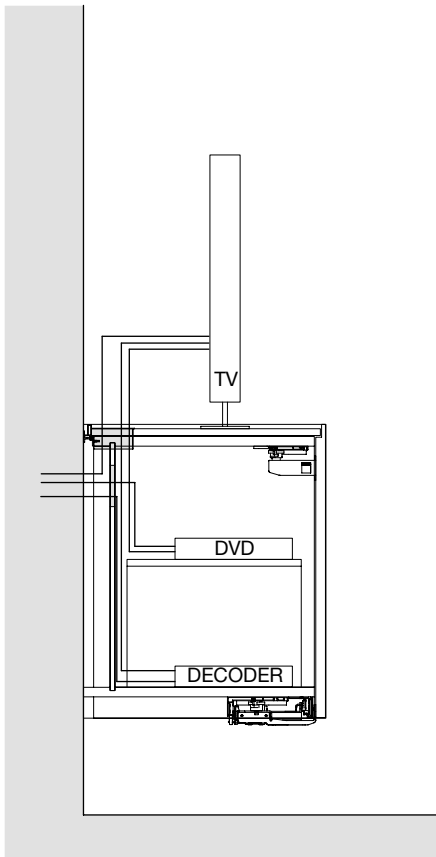

TV-portal

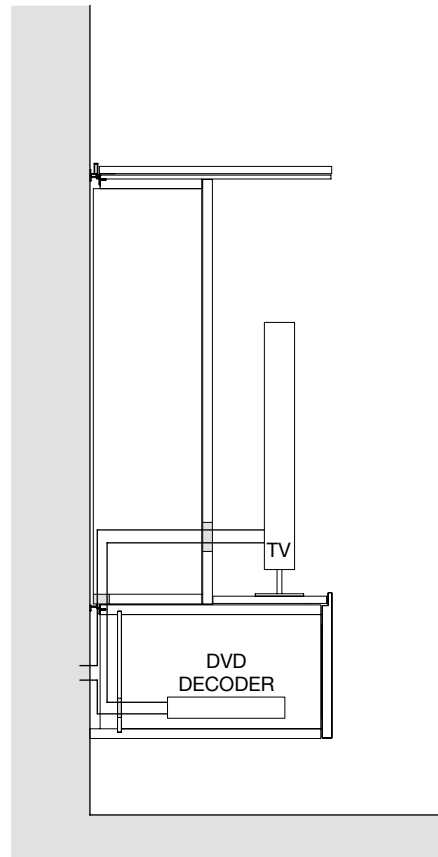

SURFACE wall panelling with thick shelf

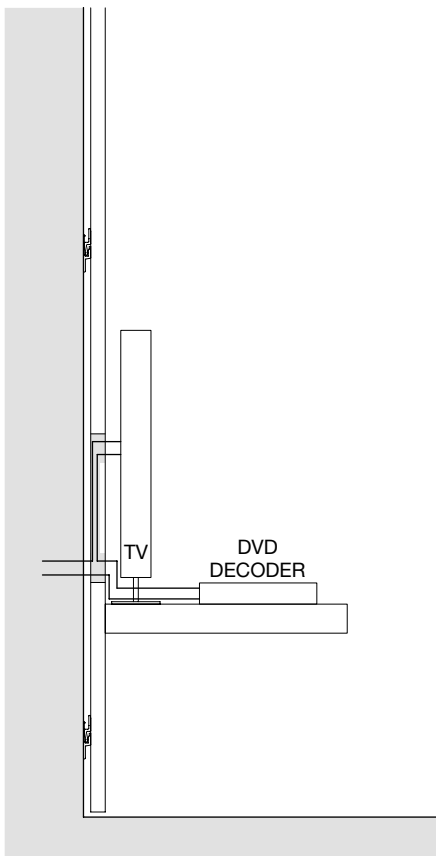

SURFACE wall panelling with storage unit

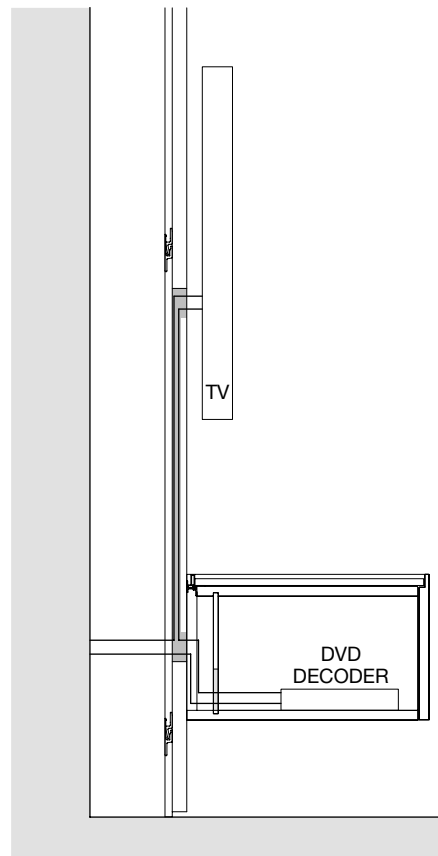

Cables passage

IR remote control

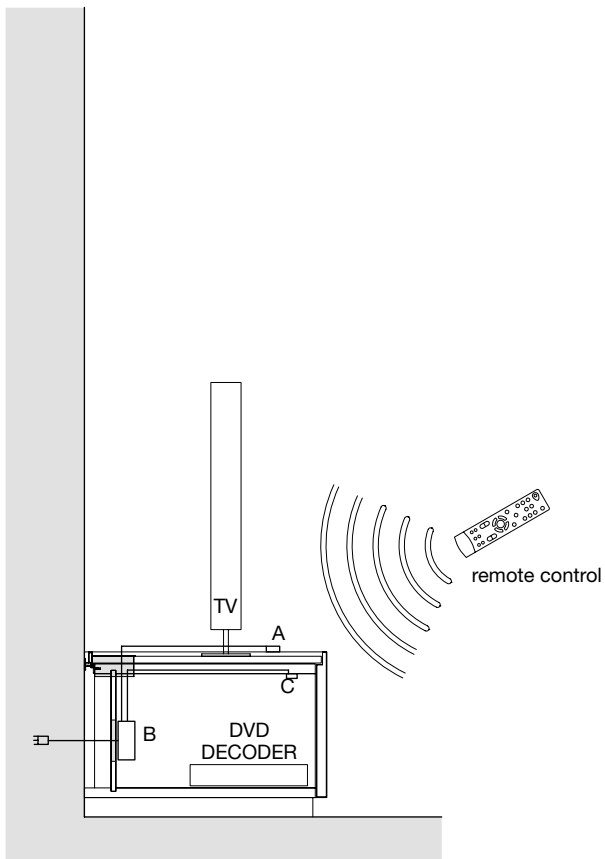

A = Signal receiver
B = Control unit
C = Repeater

Cables passage

Storage units Living

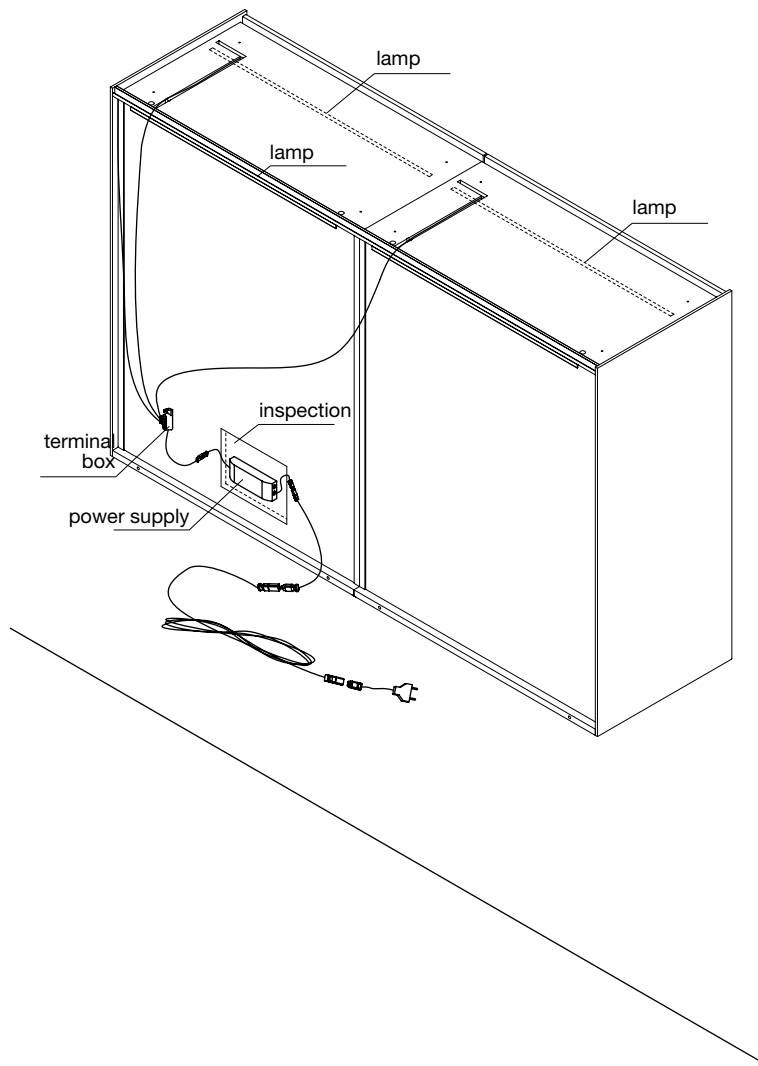

Cables passage

Single storage unit

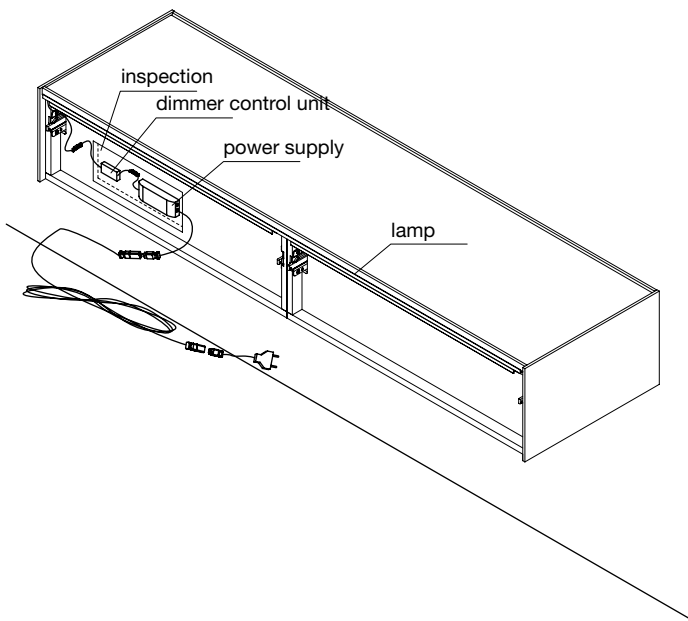

Storage units side by side

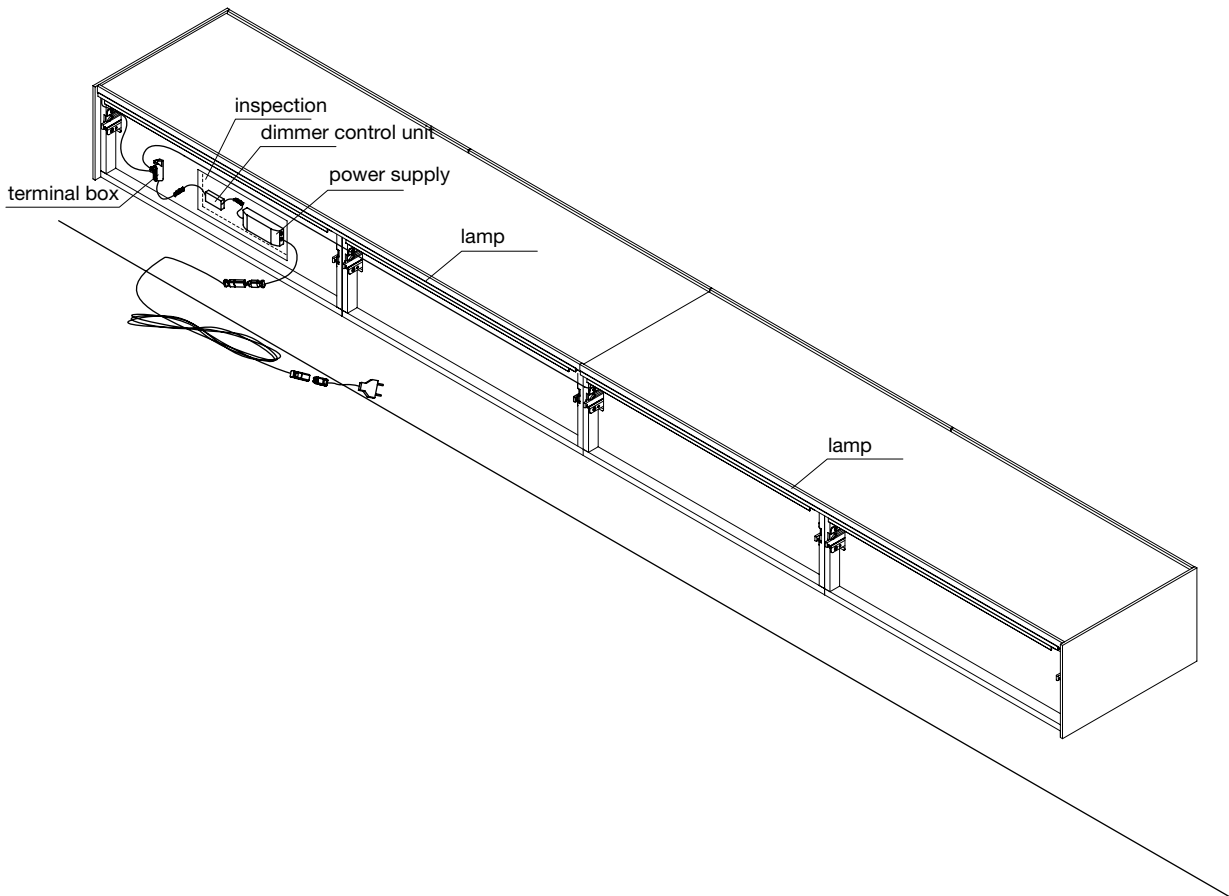

Cables passage

Open storage units

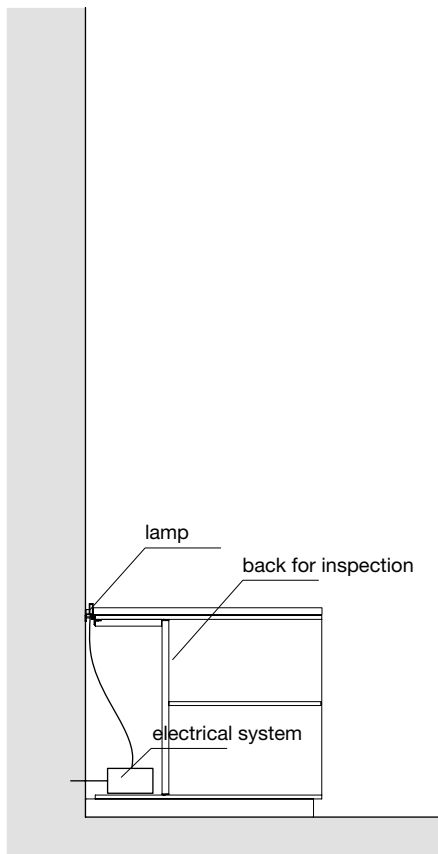
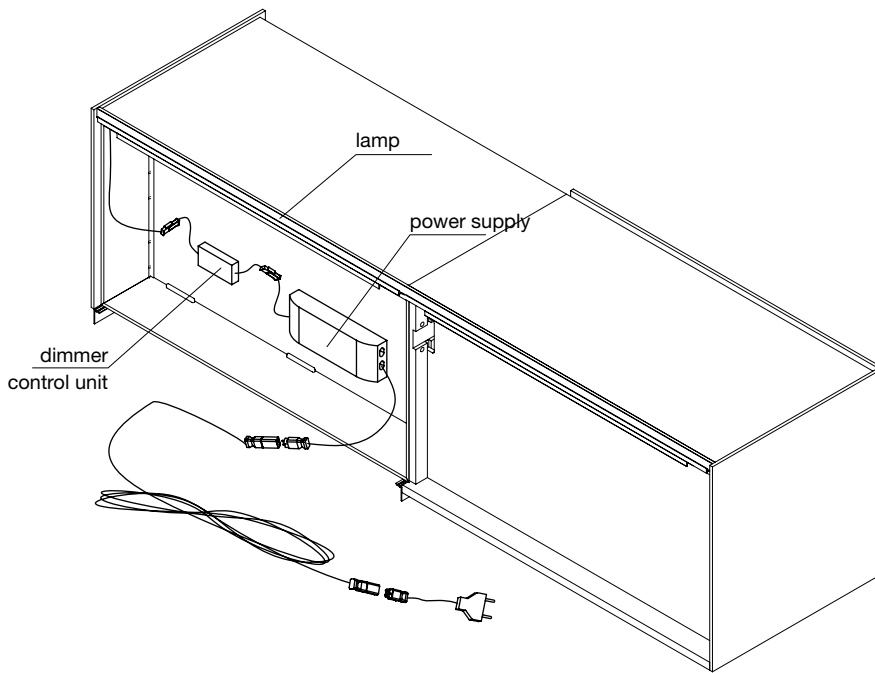

Cables passage

Open storage units

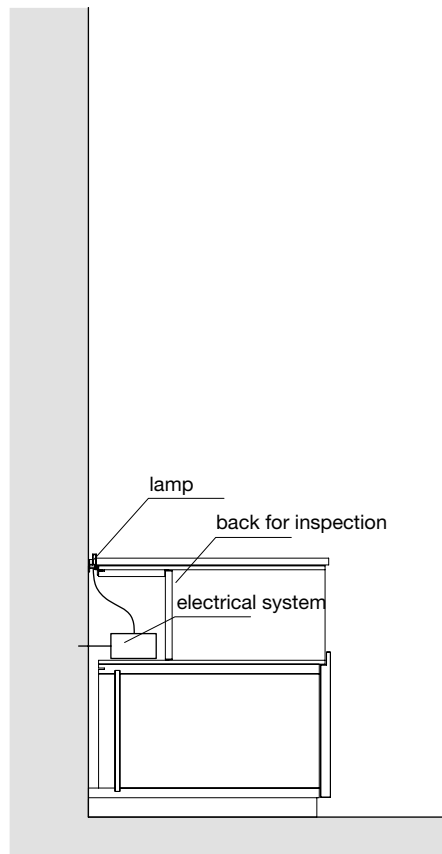
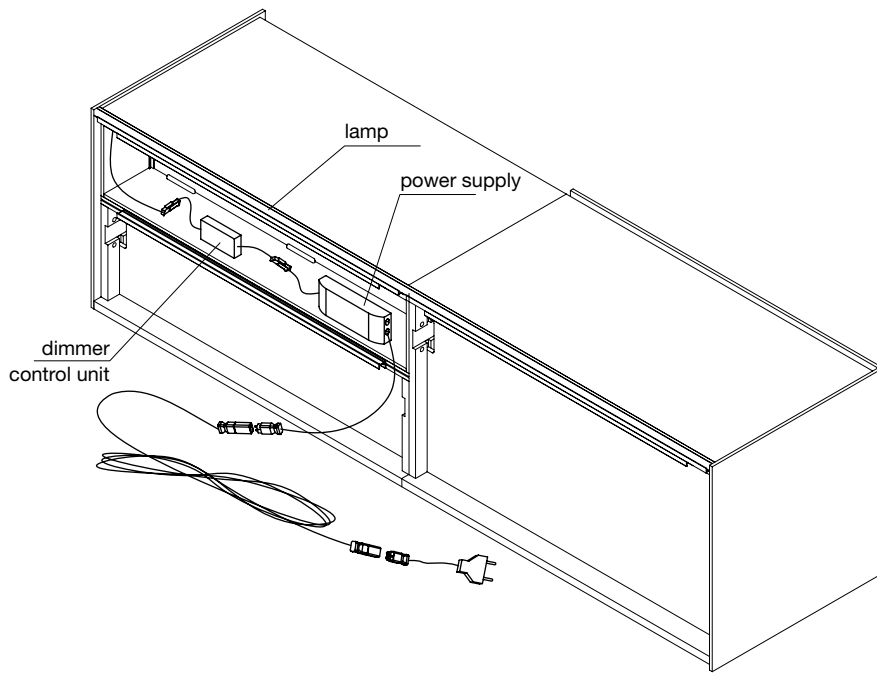

Cables passage

Open storage units Living

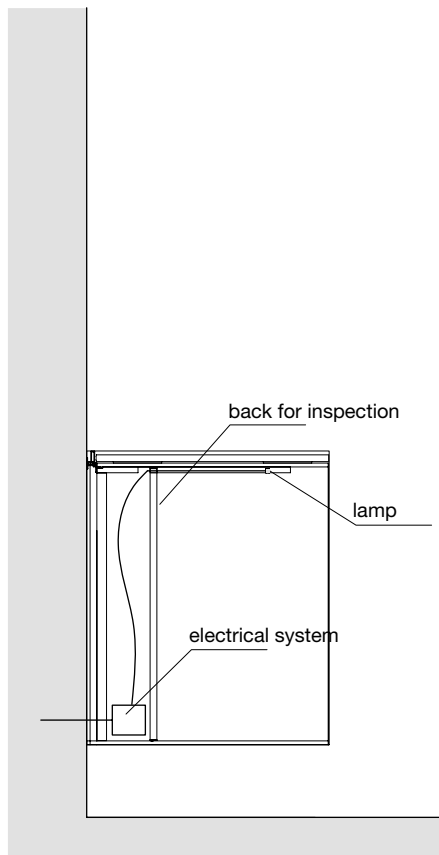
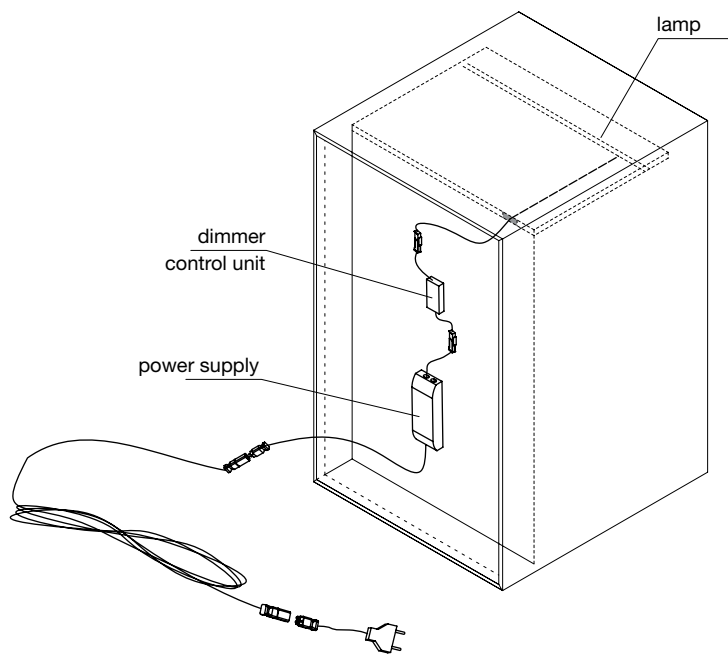

Cables passage

Hanging storage units

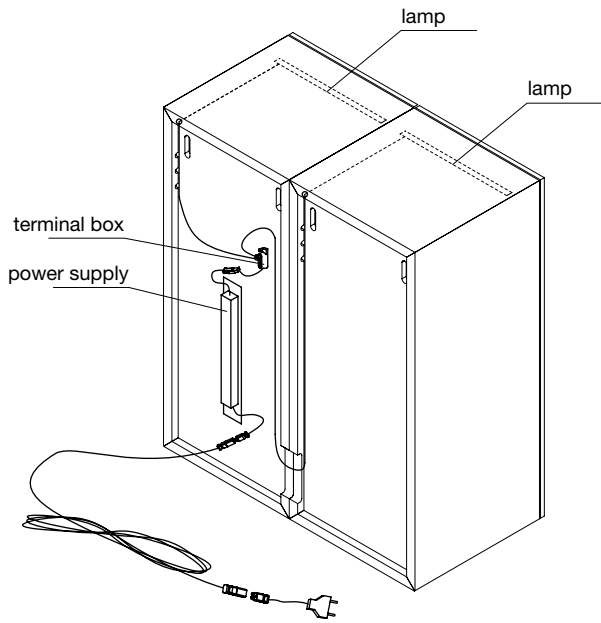

Cables passage

Hanging storage units, composition example

Hanging storage units side by side and aligned, it can be used one power supply for a number of hanging storage units according to the sum of watt.

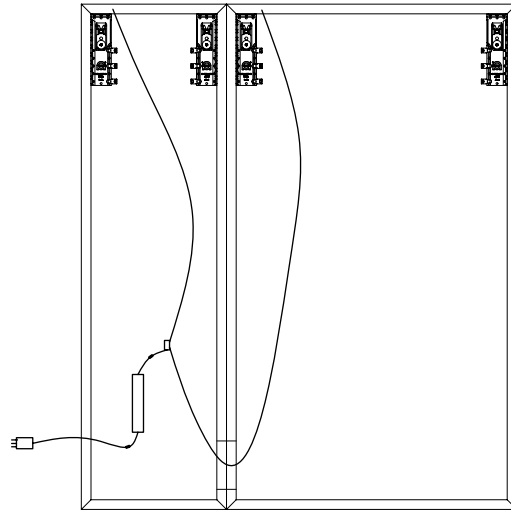
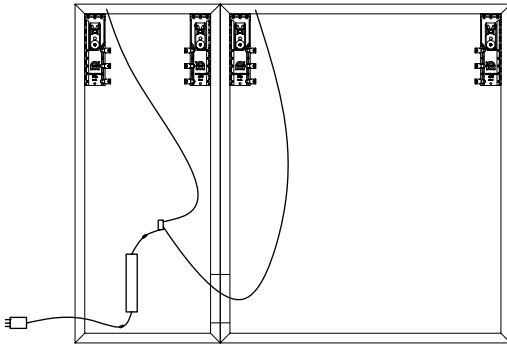

Not aligned hanging storage units h 700

Not aligned hanging storage units. In this case the hanging storage units can be electrified with one power supply (for a number of hanging storage units according to the sum of watt) as long as the misalignment is no more than 380 mm.

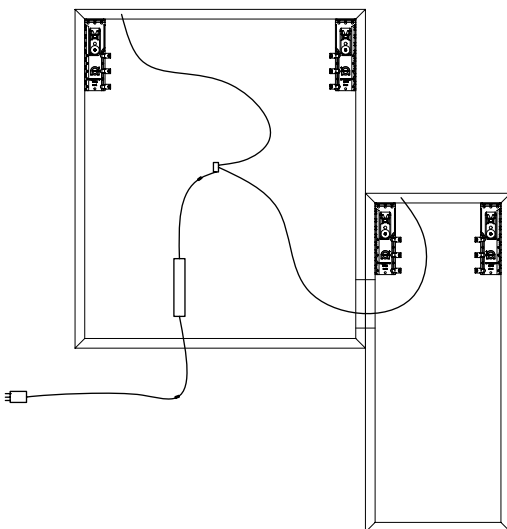

Cables passage

Not aligned hanging storage units h 1044

Not aligned hanging storage units. In this case the hanging storage units can be electrified with one power supply (for a number of hanging storage units according to the sum of watt) as long as the misalignment is no more than 724 mm.

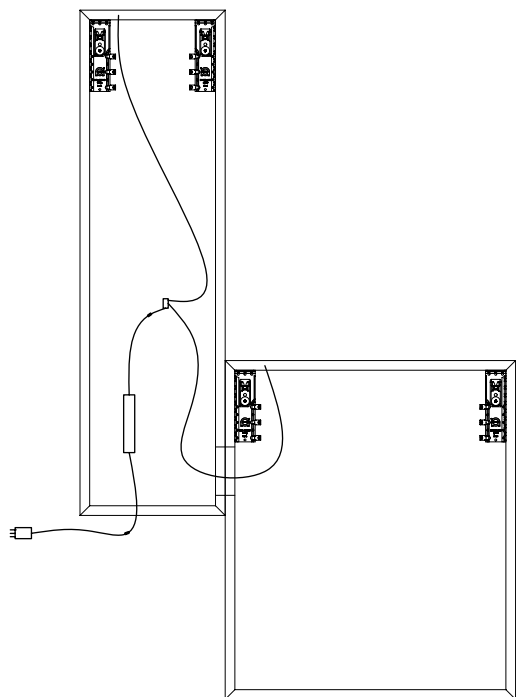

Cables passage

Shelves th 8 for wall fixing

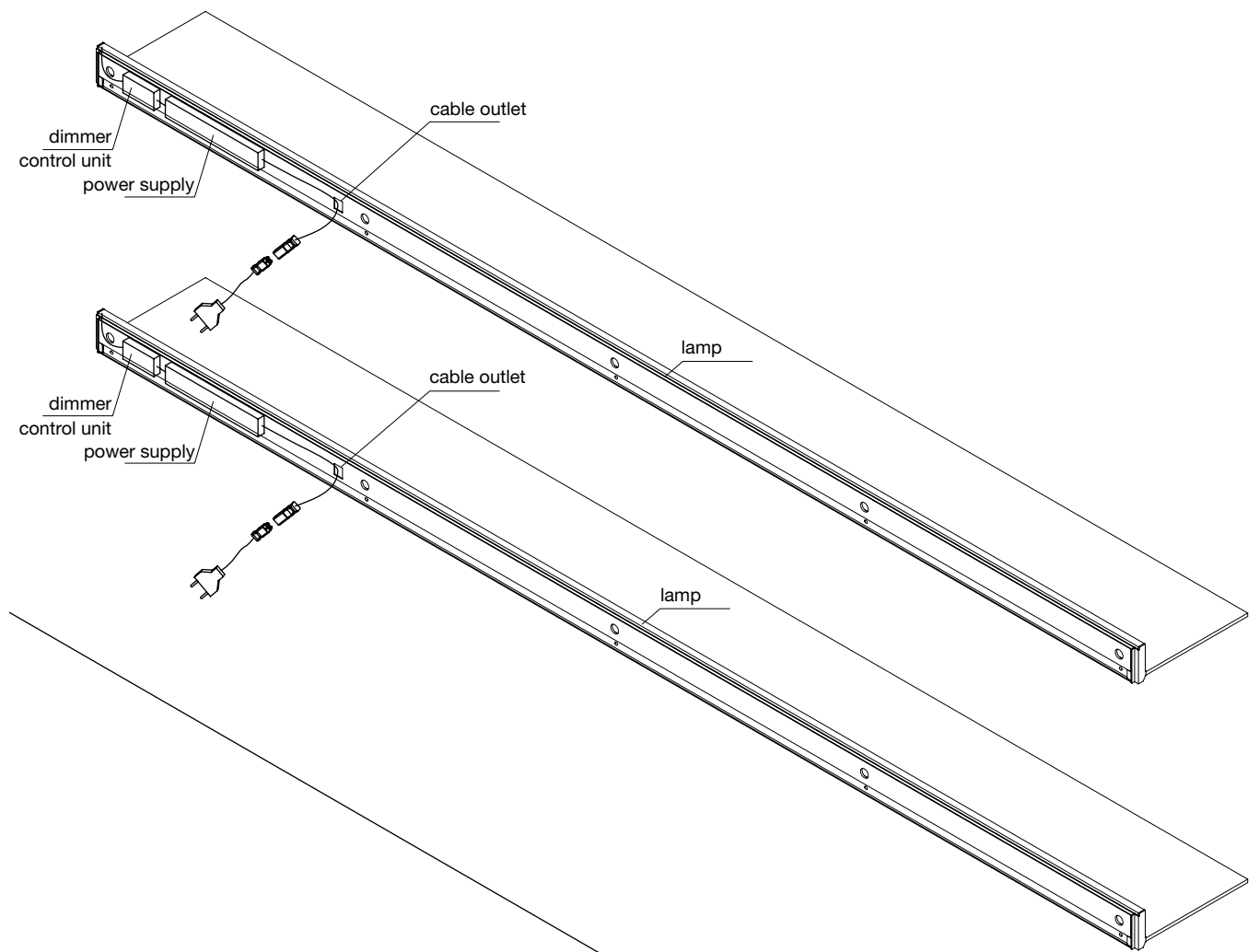

Cable outlet positioning for wall socket connection

width 600



width 900



width 1200

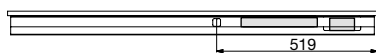

width 1800



width 2400

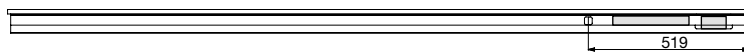

width 2700

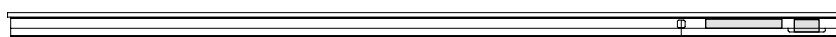

Cables passage

Thick shelf for wall fixing / thick shelf for SURFACE wall panelling

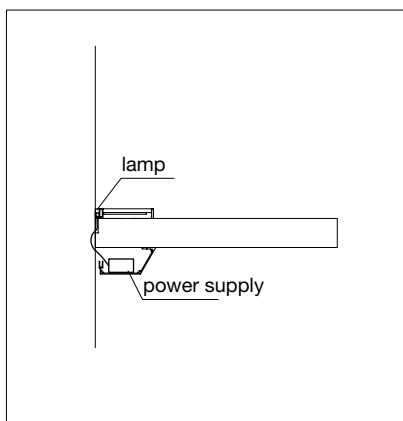
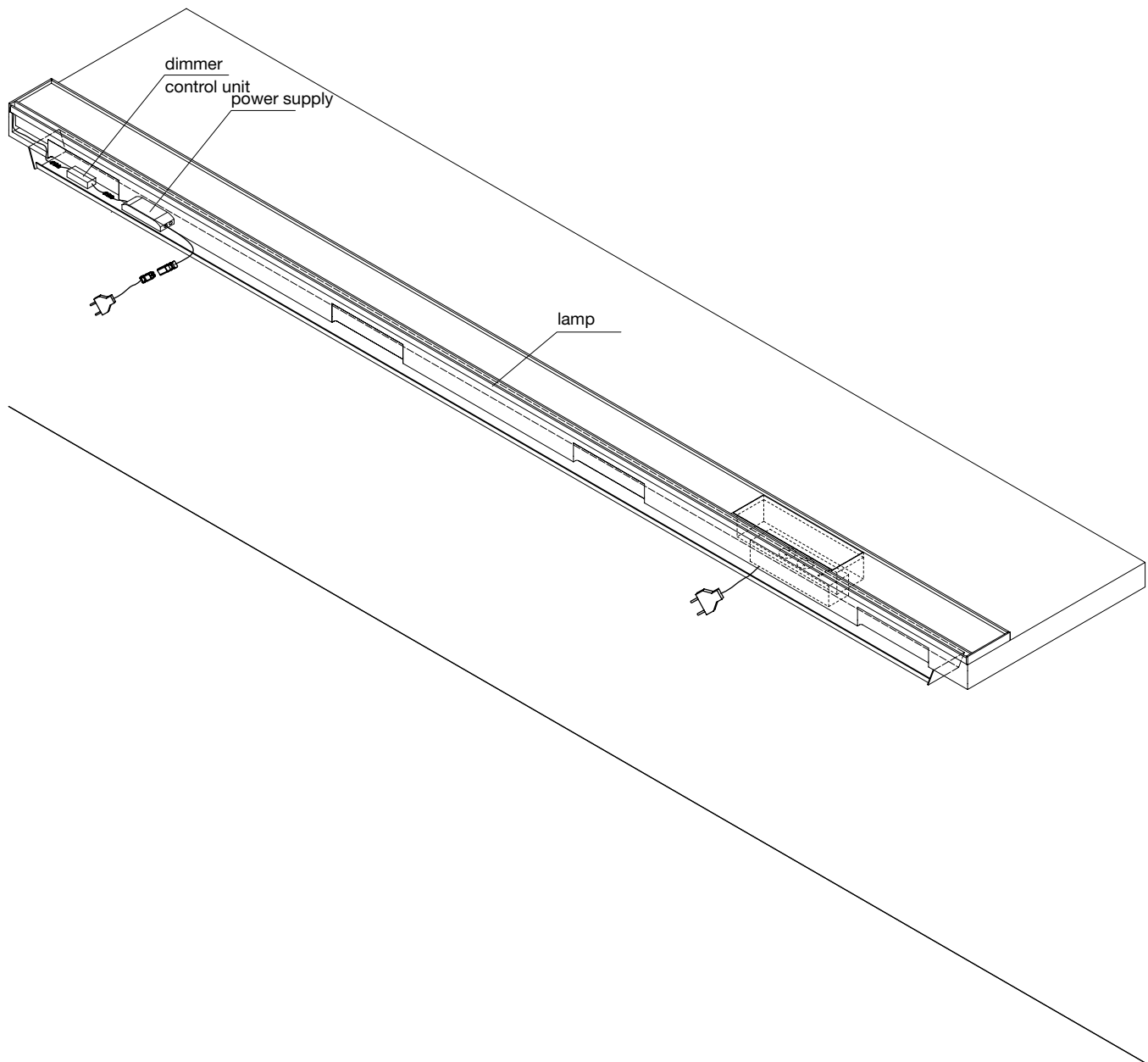

Technical description of materials

STORAGE UNITS STRUCTURE (BASE - SIDES - COVER)

Material	panel of wooden particles melamine
Thickness	20 mm
Edge	ABS
Features	available for floor positioning with aluminium painted plinth with leveler or for wall fixing and SURFACE wall panelling with height adjustable wall brackets.

STORAGE UNITS LIVING STRUCTURE (BASE - SIDES - COVER)

Material	panel of wooden particles melamine - in veneer - lacquer
Thickness	20 mm
Edge	ABS
Features	available for floor positioning with aluminium painted plinth with leveler or for wall fixing and SURFACE wall panelling with height adjustable wall brackets.

BACKS

Material	panel of wooden particles melamine
Thickness	10 mm

STORAGE UNITS LIVING BACKS

Material	panel of wooden particles melamine, in veneer - lacquer - covered in fabric
Thickness	10 - 15 - 20 mm

WOODEN SHELVES

Material	panel of wooden particles melamine - in veneer - lacquer - glass
Thickness	20 mm - 8 mm
Edge	ABS

WOODEN LEAF DOOR

Material	panel of wooden particles in veneer - lacquer
Thickness	20 mm
Edge	in veneer - lacquer
Features	soft closing mechanism

GLASS LEAF DOOR

Material	aluminium painted profile, glass th. 4 mm with painted perimeter band
Thickness	20 mm
Features	pressure opening

TAPE LEAF DOOR

Material external frame	painted aluminium and glass
Material inner frame and frame	aluminium veneered slats
Thickness	20 mm
Features	soft closing mechanism, removable frame with magnetic fixing

FINISHING TOP

Material	panel of wooden particles in veneer - lacquer - marble
Thickness	14 mm - 18 mm

HANGING THICK SHELF

Material	panel of wooden particles and medium density in veneer - lacquer
Thickness	60 mm
Features	for wall fixing with height adjustable wall brackets.

DRAWER FRONT/WOODEN FLAP DOOR FRONT

Material	panel of wooden particles in veneer - lacquer
Thickness	20 mm
Edge	in veneer - ABS

DRAWERS STRUCTURE

Material	panel of wooden particles melamine
Sides thickness	14 mm
Back thickness	14 mm
Bottom thickness	6 mm
Edge	ABS
Features	metal guides with total pulling-out ball bearings and soft closing mechanism with pressure opening.

LATERAL SIDES

Material	stratified panel in veneer - lacquer
Thickness	8 mm

STORAGE UNITS STRUCTURE FOR HANGING STORAGE UNITS

Material	medium density panel in veneer - lacquer
Structure thickness	20 mm
Back thickness	10 mm
Edge	ABS
Features	for wall fixing with height adjustable wall brackets.

WOODEN LEAF DOOR FOR HANGING STORAGE UNITS

Material	panel of wooden particles in veneer - lacquer
Thickness	20 mm
Edge	in veneer - ABS
Features	pressure opening

GLASS LEAF DOOR FOR HANGING STORAGE UNITS

Material	aluminium painted profile and glass th 4 mm
Thickness	20 mm
Features	pressure opening

SHELF FOR SURFACE WALL PANELLING

Material	aluminium plated medium density fibre panel 2 sides lacquer - glass
Thickness	8 mm

OPEN COMPARTMENTS - OPEN COMPARTMENTS LIVING STRUCTURE

Material	aluminium plated medium density fibre panel 2 sides lacquer
Thickness	8 mm
Edge	ABS
Features	equipped for adjustable wall fixing.

OPEN COMPARTMENTS - OPEN COMPARTMENTS LIVING BACK

Material	medium density fibre panel melamine - in veneer - lacquer
Thickness	15 mm
Edge	ABS + rubber

Notes

Reductions / cuts

Reductions and special manufacturing are not possible for all the other elements of the system.

Notes for order development

Unless otherwise specified:

- plinth / profiles / handles / glass doors frame in ardesia
- lateral sides in the same finish of the fronts
- finishing top in the same finish of the fronts
- storage units Living inner structure / backs in melamine ardesia
- open storage units Living backs in mat lacquer in the same finish of the structure
- hanging storage units backs in the same finish of the structure
- bookshelves backs in mat lacquer
- inner equipment excluded
- lamps excluded.

Storage units composition elements

Legenda:

- A - plinth
- B - storage unit
- D - profile
- E - open compartment
- F - lateral sides
- G - finishing top

STORAGE UNITS

two versions: floorstanding / suspended

6 widths:
450 - 600 - 900 - 1200 - 1800 - 2400

4 heights:
341/301 - 444/404 - 544/504 - 647/607

1 depth: 501

drawer - flap door - leaf doors - coplanar doors

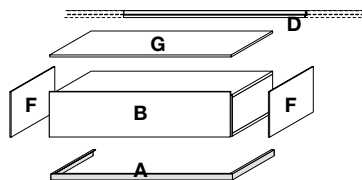

OPEN STORAGE UNITS

two versions: floorstanding / suspended

4 widths:
450 - 600 - 900 - 1200

4 heights:
341/301 - 444/404 - 544/504 - 647/607

1 depth: 501

only with open compartments

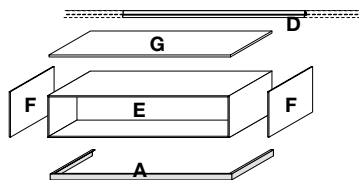

OPEN STORAGE UNITS ON STORAGE UNIT

two versions: floorstanding / suspended

4 widths:
450 - 600 - 900 - 1200

1 height:
203

1 depth: 501

only on storage units

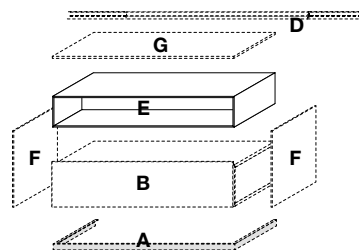

A - PLINTH

metal:

- ardesia mat
- champagne mat

D - PROFILE

metal:

- ardesia mat
- champagne mat

Note:

can be equipped with lighting system 

The plinth and the profile are already included in the price of the storage unit

B - STORAGE UNIT

INNER STRUCTURE

melamine:
- ardesia

FRONT

mat lacquer colours
metal lacquer colours

wood:

- gold oak
- walnut c
- Spessart oak
- black elm

E - OPEN COMPARTMENT

mat lacquer colours

F - LATERAL SIDES

mat lacquer colours
metal lacquer colours

wood:

- gold oak
- walnut c
- Spessart oak
- black elm

G - FINISHING TOP

mat lacquer colours
metal lacquer colours

wood:

- gold oak
- walnut c
- Spessart oak
- black elm

mat and glossy marble:

- bianco carrara
- stardust
- calacatta
- verde lepanto
- sahara noir (polyester)

mat marble:

- zecevo

glossy marble:

- saint laurent

Storage units Living composition elements

Legenda:

- A - plinth
- B - storage unit Living
- C - handle
- E - open compartment Living
- D - profile
- F - lateral sides
- G - finishing top

STORAGE UNITS LIVING

two versions: floorstanding / suspended

4 widths:
450 - 600 - 900 - 1200

2 heights:
647/607 - 1229/1189

1 depth: 501

drawer - leaf doors

OPEN STORAGE UNITS LIVING

two versions: floorstanding / suspended

4 widths:
450 - 600 - 900 - 1200

2 heights:
647/607 - 1229/1189

1 depth: 501

only with open compartments

If there are storage units placed side by side, the profile and the lamp will be as long as the composition up to a maximum width of 3000 mm. In case of longer compositions, it is necessary to divide the lamp following the finishing top junctions.

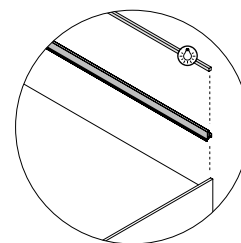
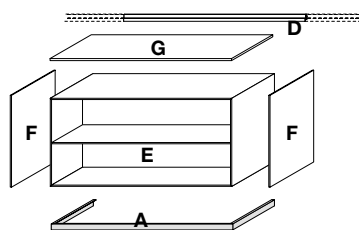
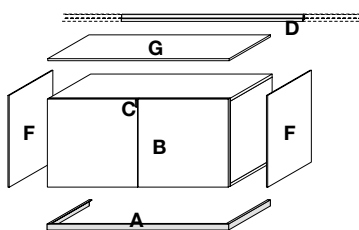

A - PLINTH

metal:
- ardesia mat
- champagne mat

C - HANDLE

metal:
- ardesia mat
- champagne mat

D - PROFILE

metal:
- ardesia mat
- champagne mat

Note:
can be equipped
with lighting system 

The plinth, the handle and the profile are already included in the price of the storage unit

B - STORAGE UNIT LIVING

INNER STRUCTURE
melamine:
- ardesia

mat lacquer colours

wood:
- gold oak
- walnut c
- Spessart oak
- black elm

BACK
melamine:
- ardesia

mat lacquer colours
metal lacquer colours

wood:
- gold oak
- walnut c
- Spessart oak
- black elm

fabric:
- lino chiaro
- lino scuro
- lino ecrù
- lino bruciato
- lino mesh ecrù
- lino mesh peltro
- lino mesh moka
- lino mesh bronzo
- lino mesh ruggine

FRONT
mat lacquer colours
metal lacquer colours

wood:
- gold oak
- walnut c
- Spessart oak
- black elm

GLASS FRONT
frame:
- ardesia mat
- champagne mat

glass:
- transparent glass 1000
- fumé glass 3050
- reflecting glass 5000
- reflecting fumé glass 5059

TAPE FONT:
- transparent glass 1000 and gold oak
- walnut c
- Spessart oak
- black elm
- fumé glass 3050 and gold oak
- walnut c
- Spessart oak
- black elm

E - OPEN COMPART. LIVING

STRUCTURE
mat lacquer colours

BACK
mat lacquer colours
metal lacquer colours

wood:
- gold oak
- walnut c
- Spessart oak
- black elm

fabric:
- lino chiaro
- lino scuro
- lino ecrù
- lino bruciato
- lino mesh ecrù
- lino mesh peltro
- lino mesh moka
- lino mesh bronzo
- lino mesh ruggine

F - LATERAL SIDES

mat lacquer colours
metal lacquer colours

wood:
- gold oak
- walnut c
- Spessart oak
- black elm

G - FINISHING TOP

mat lacquer colours
metal lacquer colours

wood:
- gold oak
- walnut c
- Spessart oak
- black elm

mat and glossy marble: *
- bianco carrara
- stardust
- calacatta
- verde lepanto
- sahara noir (polyester)

mat marble: *
- zecevo
glossy marble: *
- saint laurent

* not available on h 1189 suspended storage units

Hanging storage units composition elements

Legenda:

B - hanging storage unit

HANGING STORAGE UNITS

one version: suspended

3 widths:

300 - 450 - 600

2 heights:

700 - 1044

1 depth: 320

leaf doors

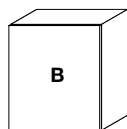

B - HANGING STORAGE UNIT

STRUCTURE

mat lacquer colours

wood:

- gold oak
- walnut c
- Spessart oak
- black elm

BACK

mat lacquer colours

metal lacquer colours

wood:

- gold oak
- walnut c
- Spessart oak
- black elm

fabric:

- lino chiaro
- lino scuro
- lino ecrù
- lino bruciato
- lino mesh ecrù
- lino mesh peltro
- lino mesh moka
- lino mesh bronzo
- lino mesh ruggine

FRONT

mat lacquer colours

metal lacquer colours

wood:

- gold oak
- walnut c
- Spessart oak
- black elm

GLASS FRONT

frame:

- ardesia mat
- champagne mat

glass:

- transparent glass **1000**
- fumé glass **3050**
- reflecting glass **5000**
- reflecting fumé glass **5059**

Bookshelves composition elements

Legenda:

B - bookshelf

BOOKSHELVES

one version: suspended

3 widths:

300 - 450 - 600

2 heights:

700 - 1044

1 depth: 320

only with open compartments

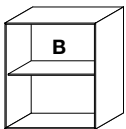

B - BOOKSHELF

STRUCTURE

mat lacquer colours

BACK

mat lacquer colours

metal lacquer colours

wood:

- gold oak
- walnut c
- Spessart oak
- black elm

fabric:

- lino chiaro
- lino scuro
- lino ecru
- lino bruciato
- lino mesh ecru
- lino mesh peltro
- lino mesh moka
- lino mesh bronzo
- lino mesh ruggine

Construction examples

Storage units / Storage units Living

- 1 Single storage unit
- 2 Storage units placed side by side
- 3 Storage unit placed side by side to open storage unit
- 4 Storage units with different heights cannot be placed side by side

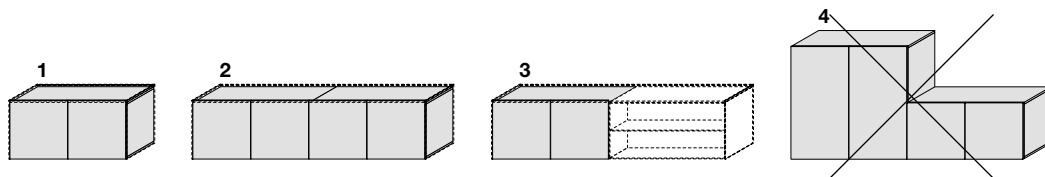

Open storage units / Open storage units Living

- 1 Single open storage unit
- 2 Open storage units placed side by side (both must have the same height)
- 3 Open storage unit placed side by side to storage unit (both must have the same height)
- 4 Open storage units with different heights cannot be placed side by side

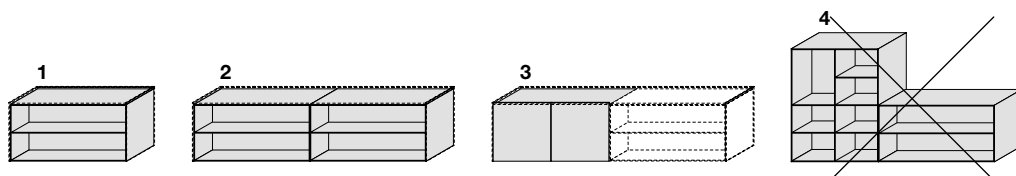

TV-portal

Note:

* Storage units Living or open storage units Living placed side by side to the TV-portal do not need the lateral sides (th 8 mm).

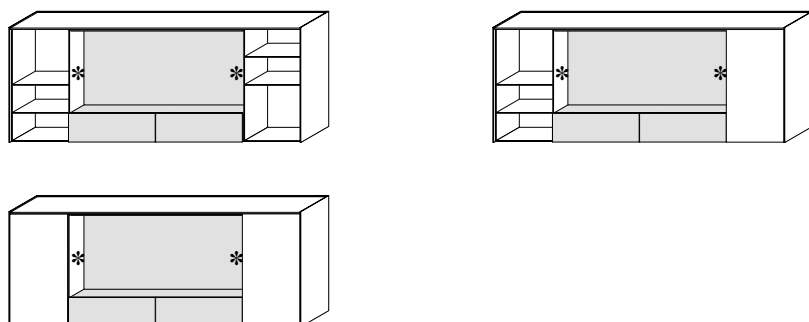

Hanging storage units

- 1 Single hanging storage unit
- 2 Hanging storage units placed side by side (both must have the same height)
- 3 Hanging storage unit placed side by side to a bookshelf (both must have the same height)
- 4 Hanging storage units with different heights can be placed side by side

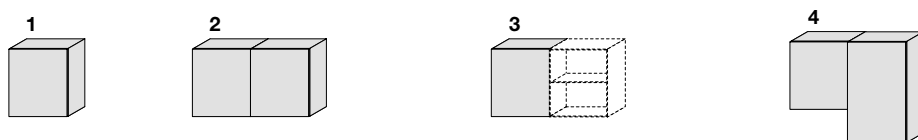

Bookshelves

- 1 Single bookshelf
- 2 Bookshelves placed side by side (both must have the same height)
- 3 Bookshelf placed side by side to the hanging storage unit (both must have the same height)
- 4 Bookshelves with different heights can be placed side by side

