





# Index

---

<b>UBIK walk-in closet</b>	
Finishes	p. 4
Technical notes	p. 8
Height positioning and alignments	p. 9
<b>UBIK walk-in closet without back panels</b>	p. 10
<b>UBIK walk-in closet with back panels</b>	p. 12
Technical drawings and sections	p. 13
Technical description of materials	p. 33
Notes	p. 34
<b>Structural elements</b>	p. 36
<b>Inner equipment</b>	p. 37
<b>Order example</b>	p. 72
<b>Order form</b>	p. 73

Panelling - Inner equipment



\* Only for back panels

\* For colours see page 6.

♣ For colours see page 7.

All the glossy glass and mirror panels, regardless of colour, are supplied with an ardesia / champagne perimetral profile.

Hardware - Metal parts

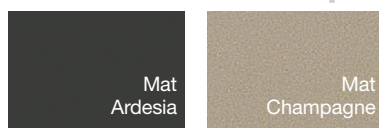

Elements not available in champagne:  
lighting system

Inner shelves - Chests of drawers tops

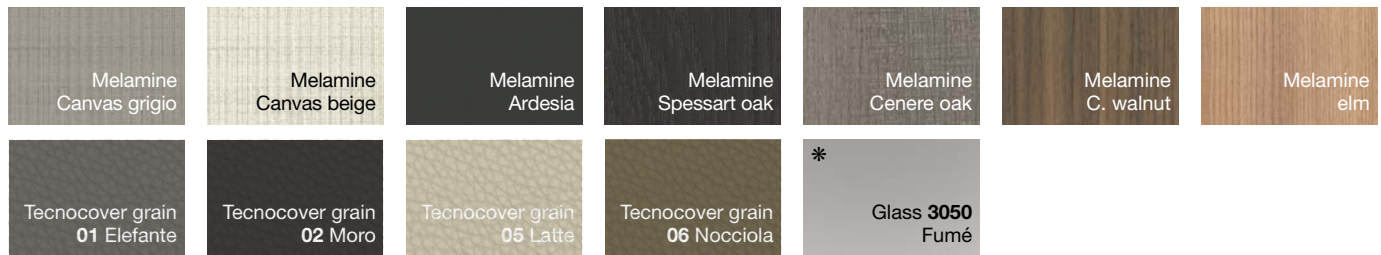

\* Not available for chest of drawers top

Hanging rails

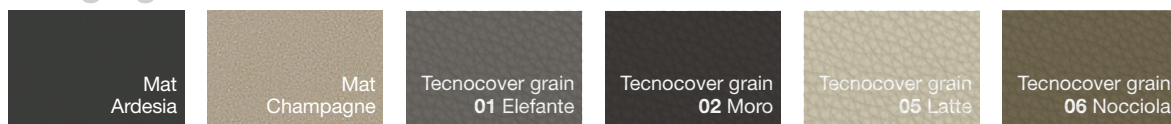

Chests of drawers structure

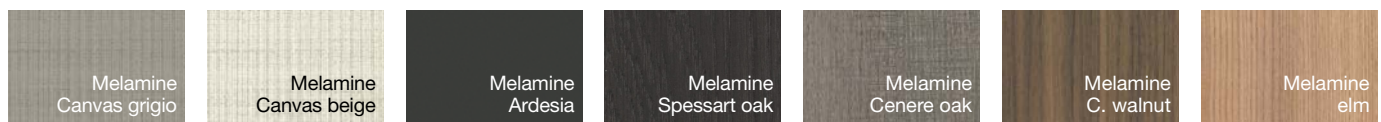

Chests of drawers fronts

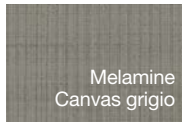

Melamine  
Canvas grigio

Drawers  
Trays  
Shoe trays

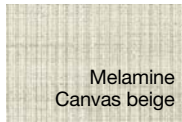

Melamine  
Canvas beige

Drawers  
Trays  
Shoe trays

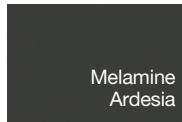

Melamine  
Ardesia

Drawers  
Trays  
Shoe trays

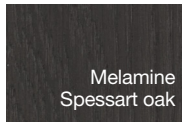

Melamine  
Spessart oak

Drawers  
Trays  
Shoe trays

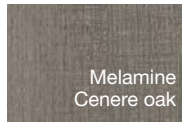

Melamine  
Genere oak

Drawers  
Trays  
Shoe trays

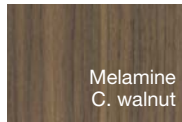

Melamine  
C. walnut

Drawers  
Trays  
Shoe trays

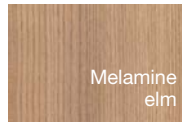

Melamine  
elm

Drawers  
Trays  
Shoe trays



Methacrylate  
Roller ardesia

Drawers

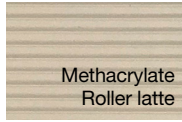

Methacrylate  
Roller latte

Drawers



Glass 5059  
Fumé reflective

Drawers

Drawers inner structure

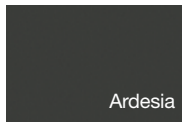

Ardesia

Skin mat lacquer colours



Also available colours:

- 94 Latte
- 93 Moro
- 97 Elefante
- 98 Nocciola

**Notes:**

For special finishes see “Customizations” section.

Metal lacquer



**Notes:**

Metal lacquers are obtained by handcrafted production process that can generate slight colour tone changes.

Glossy glass colours



Etched glass colours

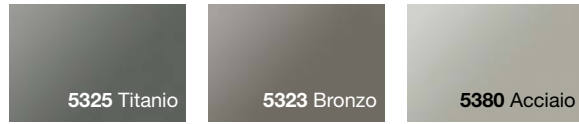

Notes:

No special or on sample paintings are foreseen for glasses.

Mirror



## Top

The shelf cannot be mounted flush with the back panel: always lowered by about 63 mm.

Possibility of further lowering (pitch 32 mm).

Possibility of width and depth reductions.

In case of replacements for corner elements, it is not possible to supply only the left or right part: the entire corner shelf (left + right part) must be supplied.

## Base

Prepared with lateral closing brackets.

Flow rate 100 kg/lm: possibility to have reinforced base (flow rate 300 Kg/lm)

The base is optional: possibility to have walk-in closet without base.

The plinth for walk-in closet is aluminium painted height 37 mm.

Possibility to have optional plinth aluminium painted height 72 mm

Possibility of width and depth reductions.

In case of replacements for corner elements, it is not possible to supply only the left or right part: the whole shelf (left + right part) has to be supplied.

Optional plinth cannot be used for out of square corners.

## Wooden back panel

Possibility of electrification (not possible after sale).

Possibility of height/width reductions.

Possibility for mansard roof, shaping, through holes.

Possibility of inspection.

In case of replacements for corner elements, only the left or right side can be supplied.

Adjustable feet height 6 mm.

## Glass back panel

Possibility of electrification (not possible after sale).

Possibility of height/width reductions.

Impossibility for mansard, shaping, through holes.

Not possible of inspection.

In case of replacements for corner elements, only the left or right side can be supplied.

Adjustable feet height 6 mm.

## Initial / end lateral profile

Width 32 mm x depth 60 mm not modifiable.

Possibility of height reductions.

Impossibility for mansard, shaping.

## Initial / end latera adjusting filler

Minimum allowed technical width: 60 mm (the fixing rack does not allow a smaller width).

If supplied with w. 300 mm as standard: adaptable on site up to minimum w. 60 mm.

Possibility of height/width reductions.

Possibility for mansard roof, shaping.

Adjustable feet height 6 mm.

## Special end profile

Max. width 300 mm / width not modifiable on site / min. available width 60 mm.

Max. depth 150 mm / depth modifiable on site / min. available depth 60 mm.

Possibility of height reductions.

Impossibility for mansard, shaping.

## Linear shelves

Can be raised/lowered (pitch 32 mm).

In the finish TecnoCover grain with front/frame it is recommended to use it up to a maximum height of 1630 mm.

Melamine corner shelves with front and TecnoCover grain cannot be used with out of square corners.

Possibility of width/depth reductions.

Shelf in TecnoCover grain with front: not available.

## Shoestand inclined shelf shelves

Can be raised/lowered (pitch 32 mm).

Possibility of width reductions.

Impossibility of depth reductions.

## Hanging rails

Any reduction in width of the tube can be managed only by Poliform.

Possibility of fixing the tube to the shelf (excluding glass shelf) also after sales.

## Pull down hanging bar

It can not be used in walk-in closet without back panels.

## Chests of drawers

Drawers with full extraction glides and soft closing.

Possibility of reducing drawers in width (except glass drawers).

Possibility of reducing drawers in depth (except shoe trays).

Freestanding chests of drawers tops not available in melamine with front and TecnoCover grain with front.

## Hanging chests of drawers

Not available for Ubik without back panel.

Hanging chests of drawers tops not available in TecnoCover grain with front.

## Shirt storage / handbags hanger / shoe shelf

They can not be reduced.

## Hanging chests of drawers display case

Not available for Ubik without back panel.

It can be used individually or equipped at the bottom with hanging drawers or tray / trousers hanger.

Inner light and TecnoCover grain bottom already included in the price of the element.

## Trousers hanger / Trays

They can not be used with Ubik without back panel.

Impossibility of width/depth reductions.

## Lamps

They can not be used in walk-in closets without back panels.

Possibility of width reduction.

With lamps, the electrification of the plate is already included in the price of the shelf, while the electrification of the back panel has to be calculated separately.

## Structural elements, equipment customization

See section "Customizations".

## Hardware

See section "Customizations".

## Price calculation of the walk-in closet with back panels

Sum the prices of the individual structural components (method used in order confirmation).

For back panels the price of the fixing rack is already included.

Shelf already includes the price of shelf brackets.

In the top of the hanging chests of drawers the price of shelf brackets is already included.

In the base the price of the side brackets is already included.

With lamps on the shelves, the electrification of the plate is already included in the price of the shelf, while the electrification of the back panel has to be calculated separately.

## Notes for order development

Unless otherwise specified:

- walk-in closet depth 605
- walk-in closet with back panel and with bases
- bases with plinth standard height 37 mm
- inner shelves and chests of drawers tops: finish in melamine
- hanging rails and metal parts: finish in ardesia
- inner drawers: with Track handle
- adjusting fillers: standard width 300 mm
- possible presence of lamps: wall switching by the customer (no remote control)

## Height assembly

A space greater than 20 mm is recommended.

## Width assembly

Ubik with back panel: a minimum lateral space of 20 mm is required.

Ubik without back panel: minimum lateral space of 10 mm is required.

## Depth assembly

A front space of at least 50 mm is required with respect to the finished total obstruction of the composition (ex. Ubik with back panels total depth 605-460 / Ubik without back panels total depth 579-434).

## Notes for the assembly

No mounting on plasterboard walls.

The hardware supplied does not include screws for the racks fixing on the wall (as we do not know the features of the wall to which they have to be fixed).

## Adjustment and levelling

The composition levelling is achieved by adjustable feet mounted on the back panels.

## Colour variations

Elements with wooden finishes may be subject to colour variations over time due to light and ageing of the wood.

In case of completion, differences in tone may occur which will fade over time.



# Height positioning and alignments

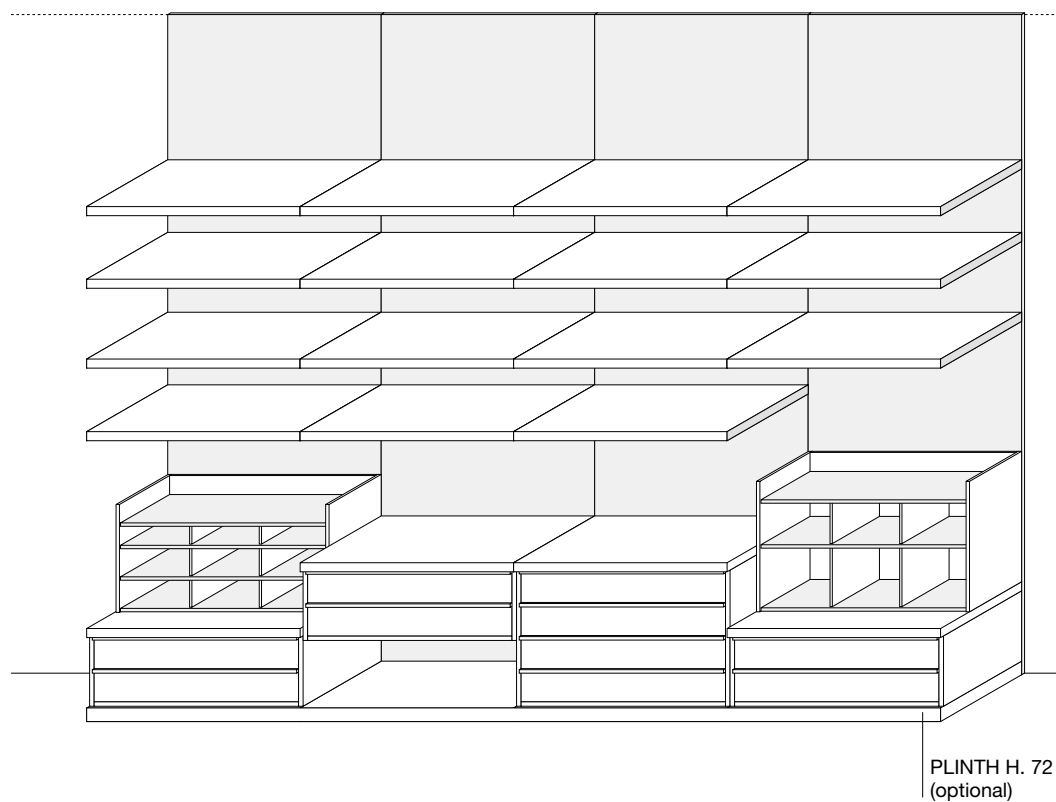
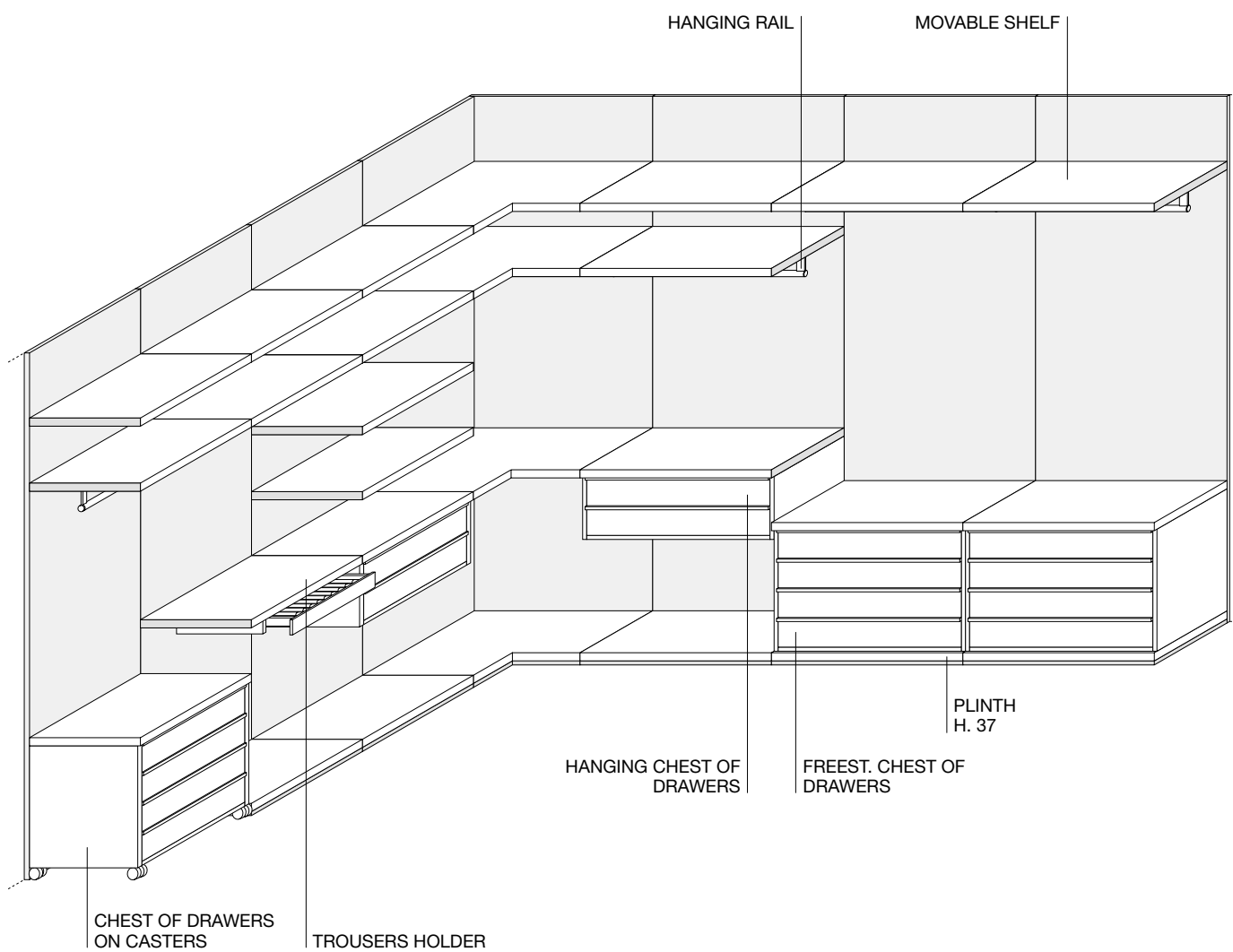

# UBIK walk-in closet without back panels

## Height positioning and alignments

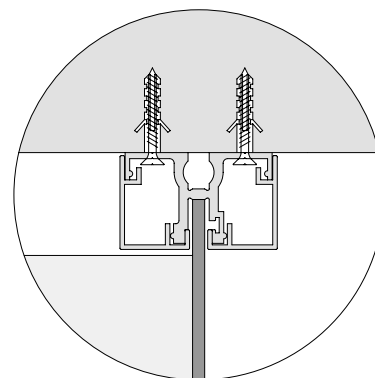
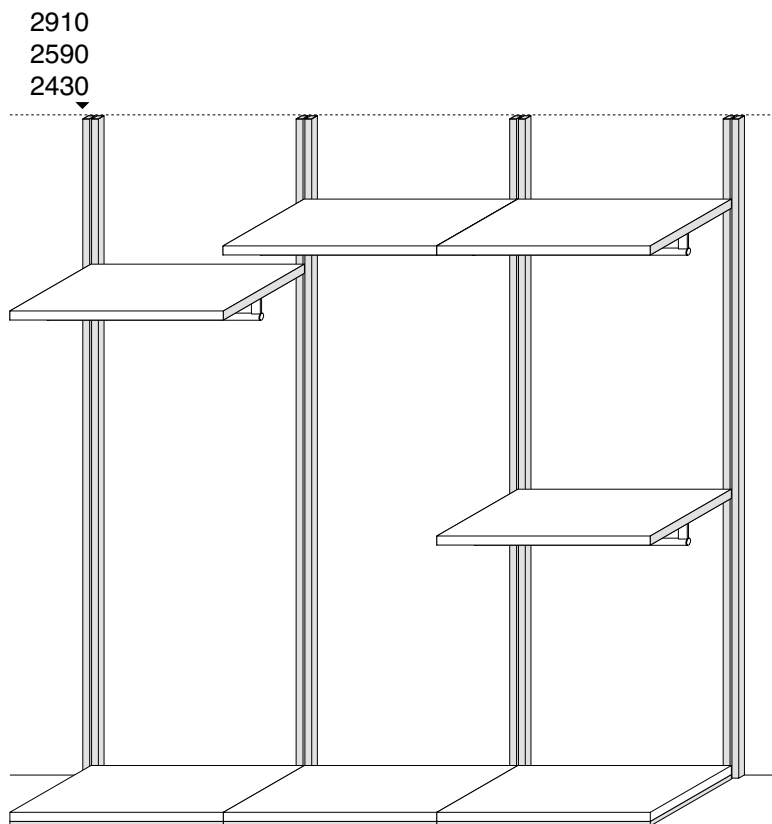

dimensions	description finishes	code price
------------	-------------------------	---------------

**Profile with rack for walk-in without back panels**  
wall fixed



height	2430	2590	2910
<b>width 52 - depth 34</b>	<b>PCE</b>	<b>PC8</b>	<b>PC9</b>
ardesia	207	207	231
champagne	207	207	231

# UBIK walk-in closet without back panels

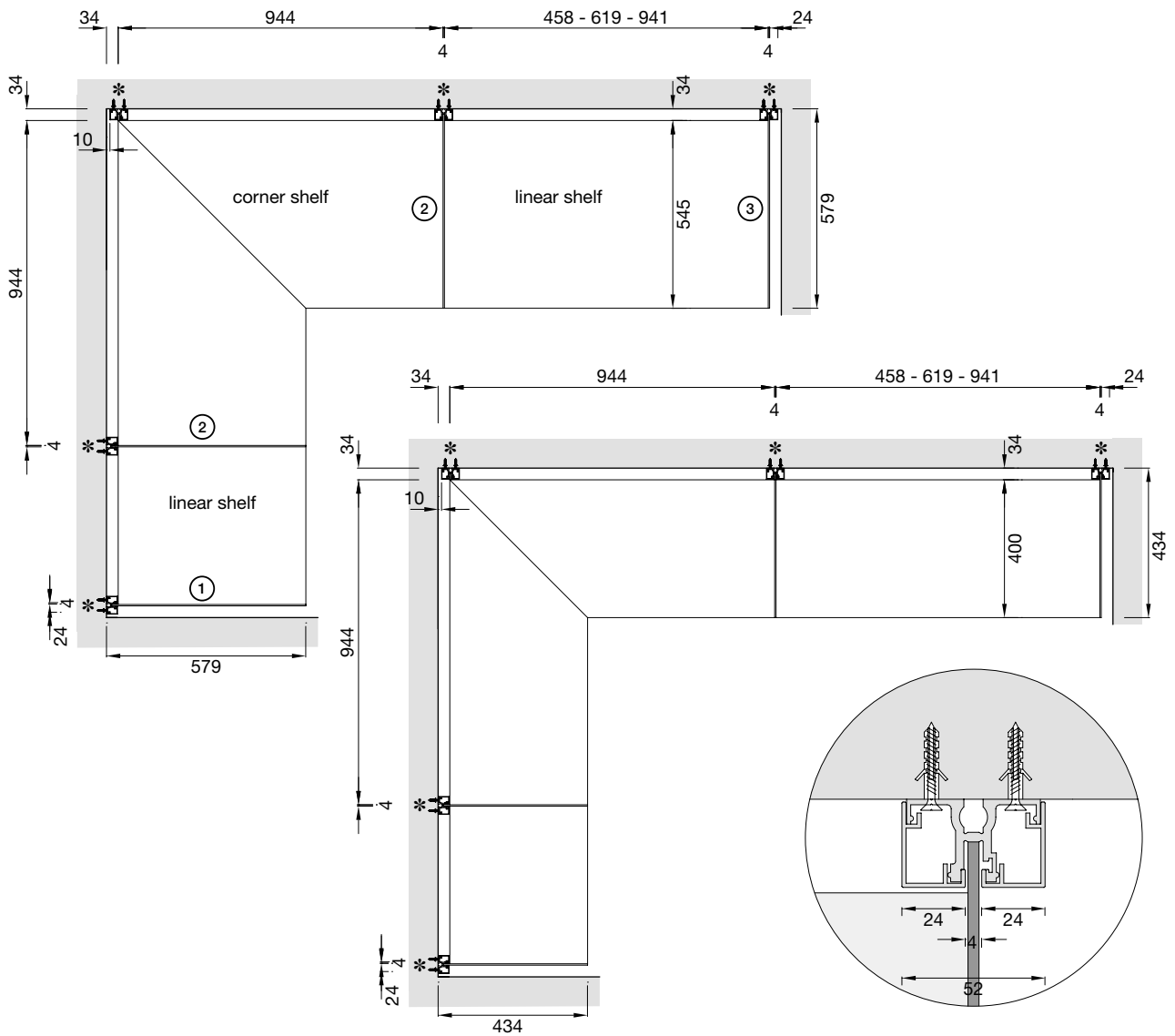

## UBIK walk-in closet without back panels with equipped linear corner

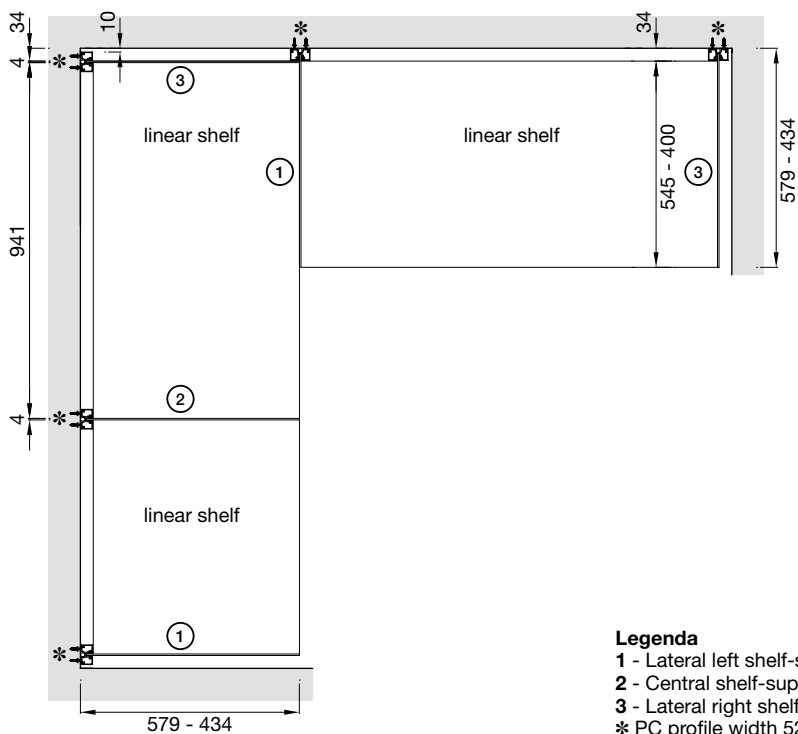

### Legenda

- 1 - Lateral left shelf-supporting plate
- 2 - Central shelf-supporting plate
- 3 - Lateral right shelf-supporting plate
- \* PC profile width 52 depth 34 mm

# UBIK walk-in closet with back panels

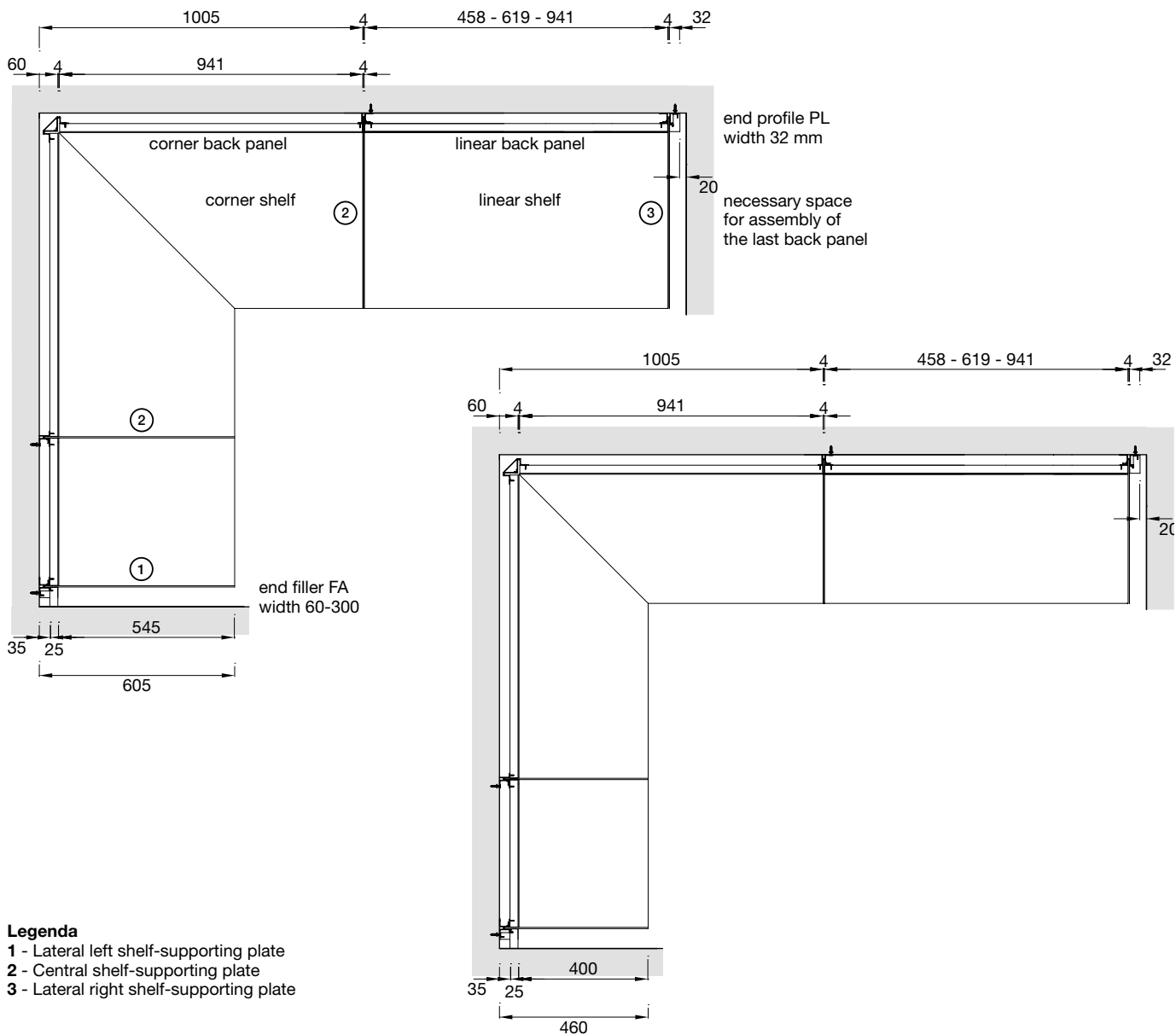

- Legenda**
- 1 - Lateral left shelf-supporting plate
  - 2 - Central shelf-supporting plate
  - 3 - Lateral right shelf-supporting plate

## End adjustment filler

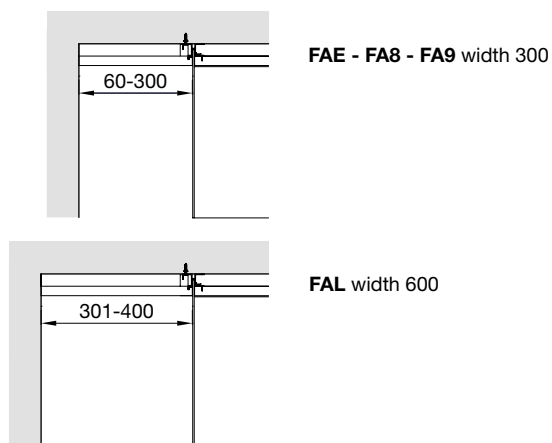

## Option to the PL end profile

PT profile for out of square wall

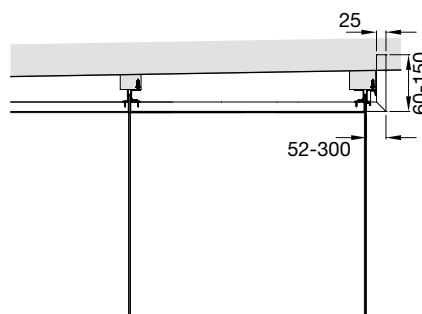

## Notes:

- final width PT: to specify on the order (cannot be reduced locally)
- depth PT: it is possible to reduce it locally (min. 60 mm)

# Racks typology

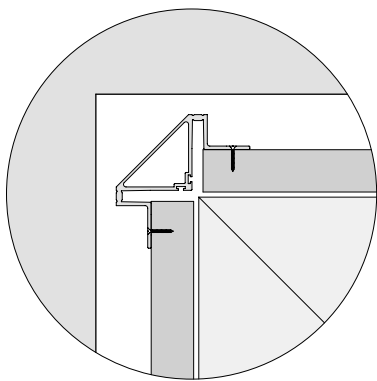
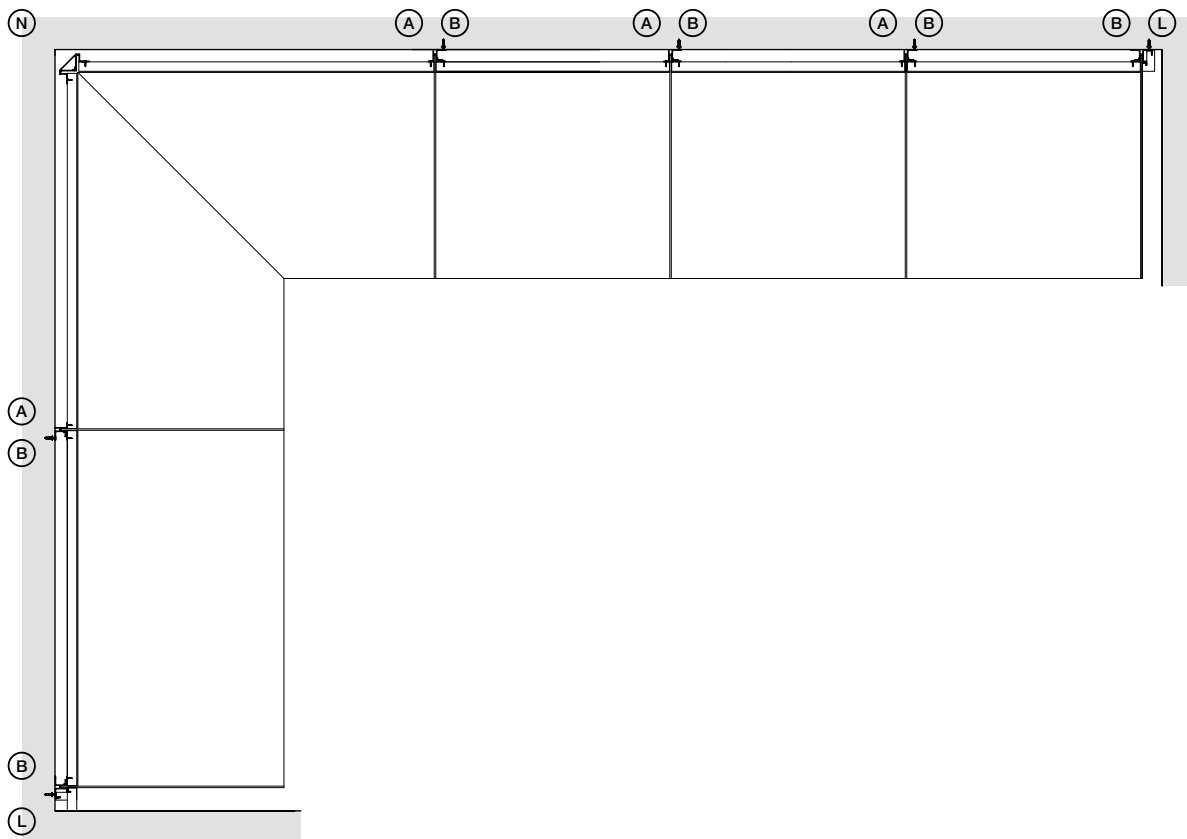

**N = Corner racks**

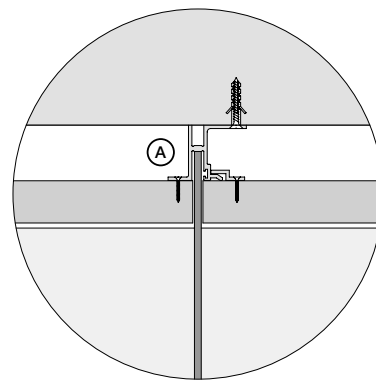

**A = High central racks**

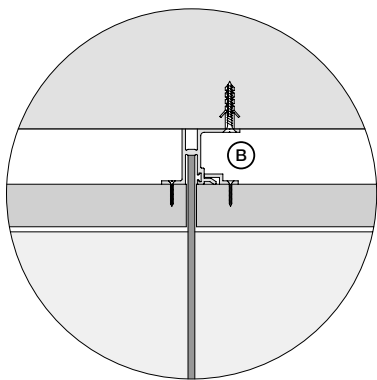

**B = Low central racks**

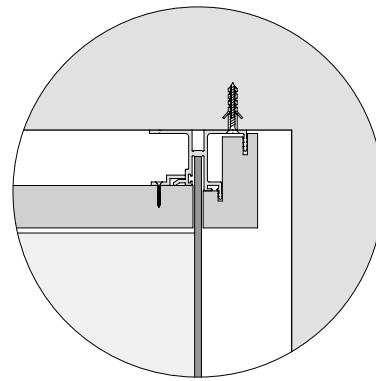

**L = Lateral racks**

# Lateral closing

## Ubik walk-in closet placed next to wardrobe

no end profile: special rack "F"

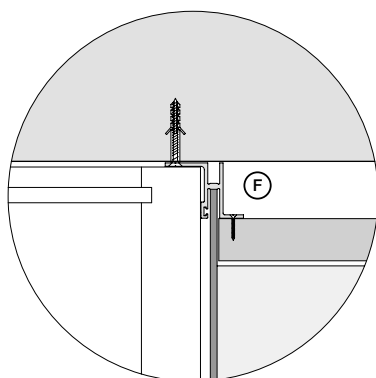
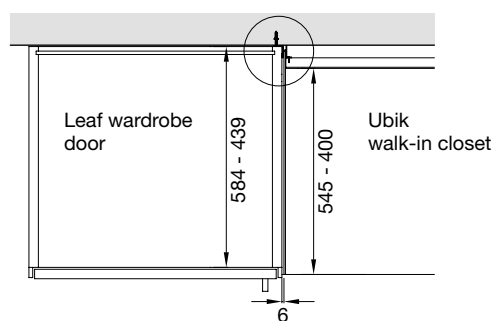

## Panels used as lateral closing

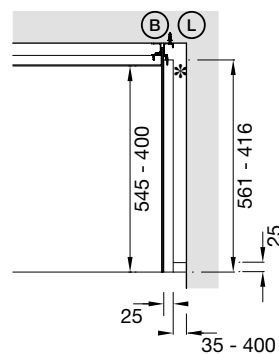
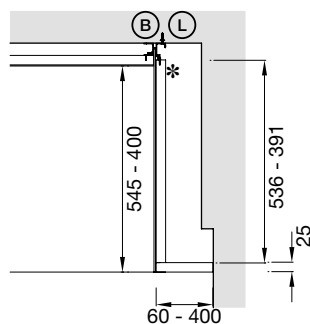
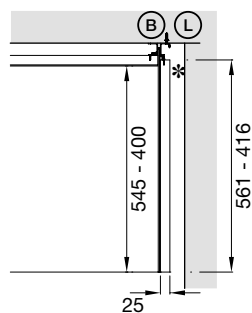

composition management  
- extra customized back panel (1 cut)

Code: **SL001**  
melamine **€348**  
melamine skin mat colours (\*\*\*) **€ 766**  
roller (\*\*\*) **€ 1.240**

Code: **SL002**  
melamine **€348**  
melamine skin mat colours (\*\*\*) **€ 766**  
roller (\*\*\*) **€ 1.240**

### Notes:

\* central low rack B assembled in milled on the edge of the panel

With back panel in melamine skin mat lacquer colours the visible edge th 25 mm will be in mat lacquer colours.

# Out of square corner

## Profile for out of square corner

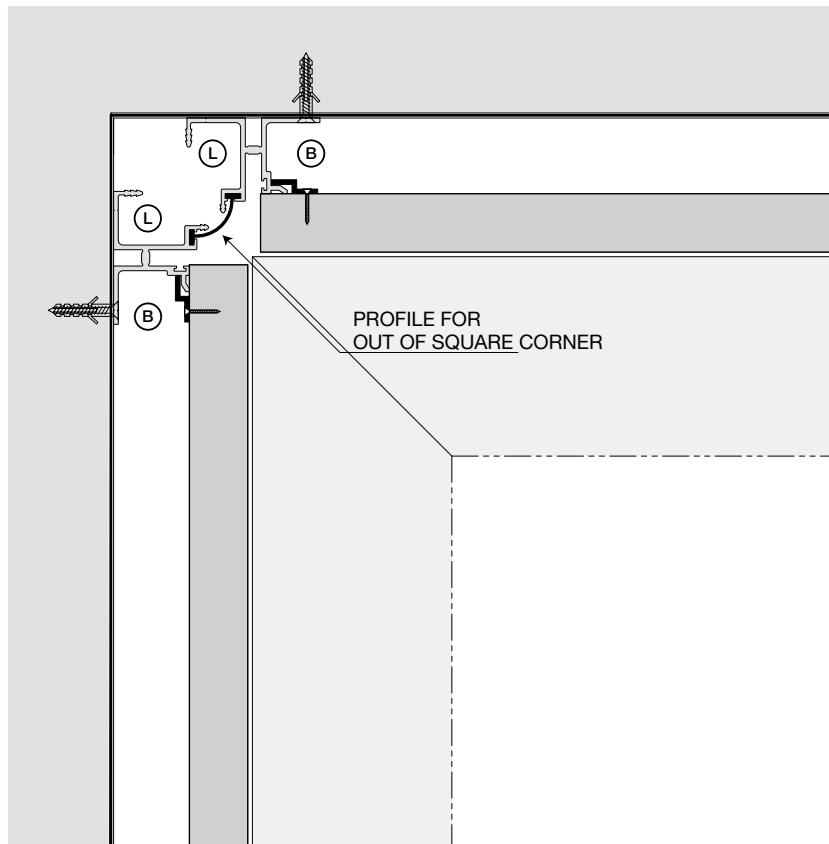

## Out of square corner

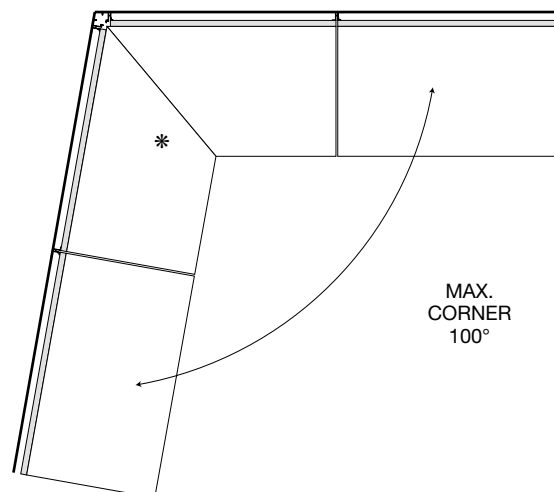
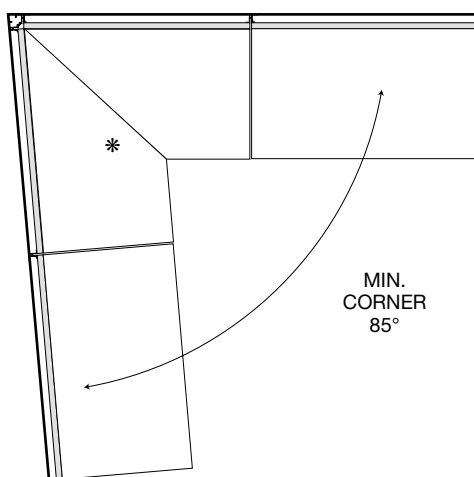

### Notes:

For out of square corners, consider a surcharge of € 107 for each shelf or base.  
It is possible to make out of square corners also with walk-in closet without back panels.  
In out of square corner it is not possible to assemble hanging chest of drawers.

\* it is not possible to use elements:

- optional plinth height 72 mm
- corner shelves with painted ardesia front
- corner shelves in Tecnocover grain with painted ardesia front
- corner shelves in Tecnocover grain with painted ardesia frame
- hanging chests of drawers

# Back panels and shelves on corner units

standard corner back panel  
equipped with standard corner shelf

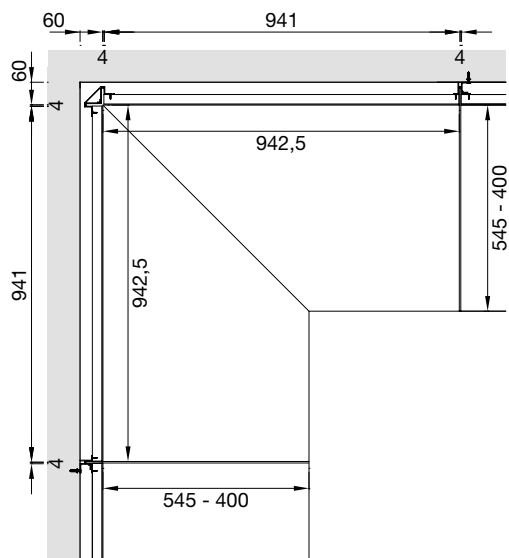

standard corner back panel  
equipped with standard shelf width 941

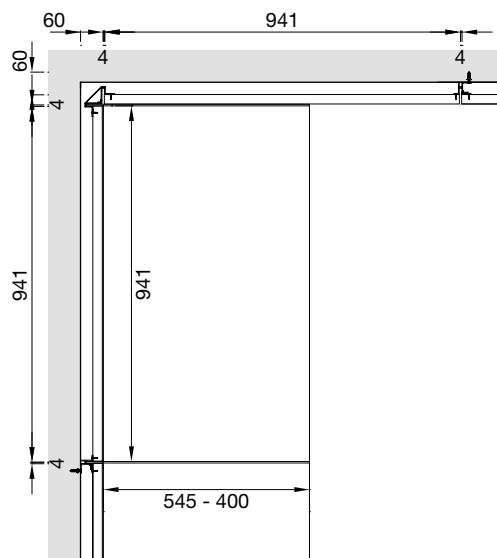

corner back panel with 1 customized side  
equipped with standard shelf width 941

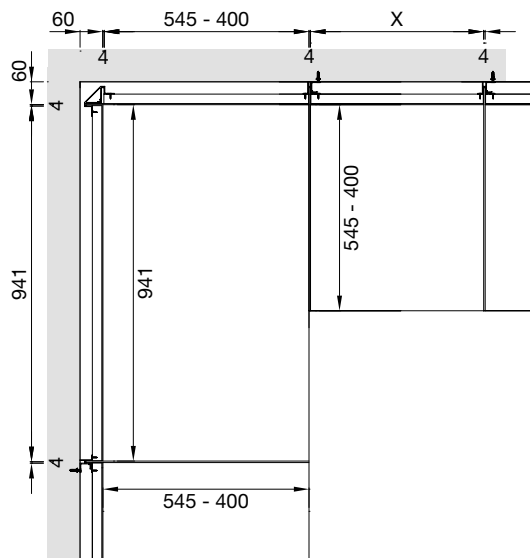



# Heights and shelves

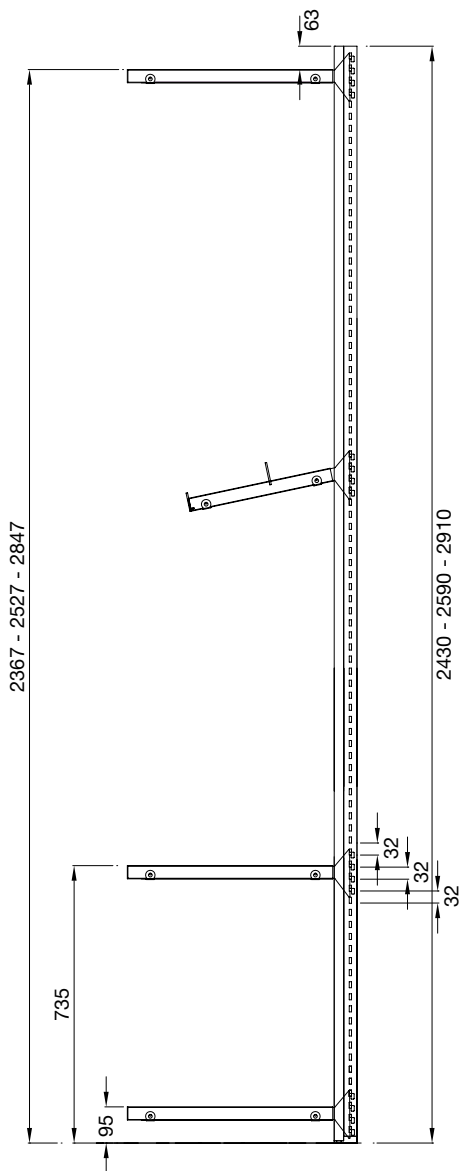

**Notes:**

rack with continuous drilling 32 mm.  
to calculate shelf top height: for example h. 735, consider +/- 32 mm to have all possible heights

**Ubik with back panel**

linear shelf  
(min. feasible depth) 200 mm

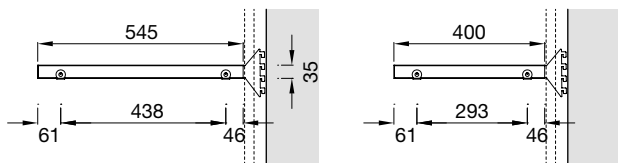

inclined shoes shelf  
(cannot be reduced in depth)

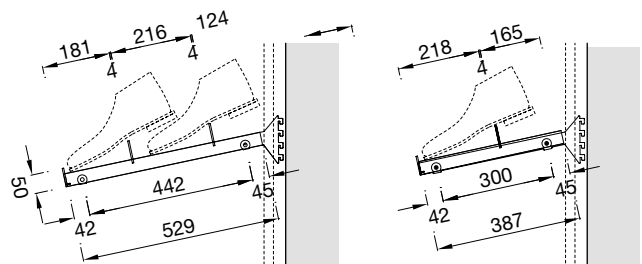

**Ubik without back panel**

linear shelf  
(min. feasible depth) 200 mm

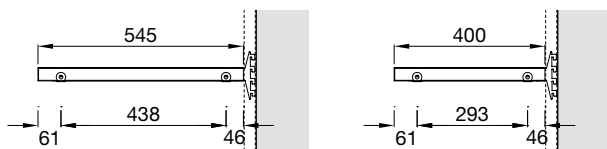

inclined shoes shelf  
(cannot be reduced in depth)

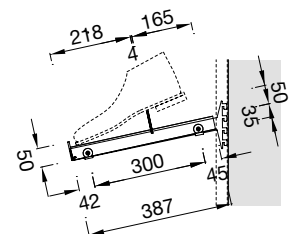

# Heights and shelves

- ① Freestanding chest of drawers height 359 leaning on the base: **not aligned** with the shelf besides
- ② Freestanding chest of drawers height 663 leaning on the base: **aligned** with the shelf besides
- ③ Freestanding chest of drawers height 967 leaning on the base: **not aligned** with the shelf besides

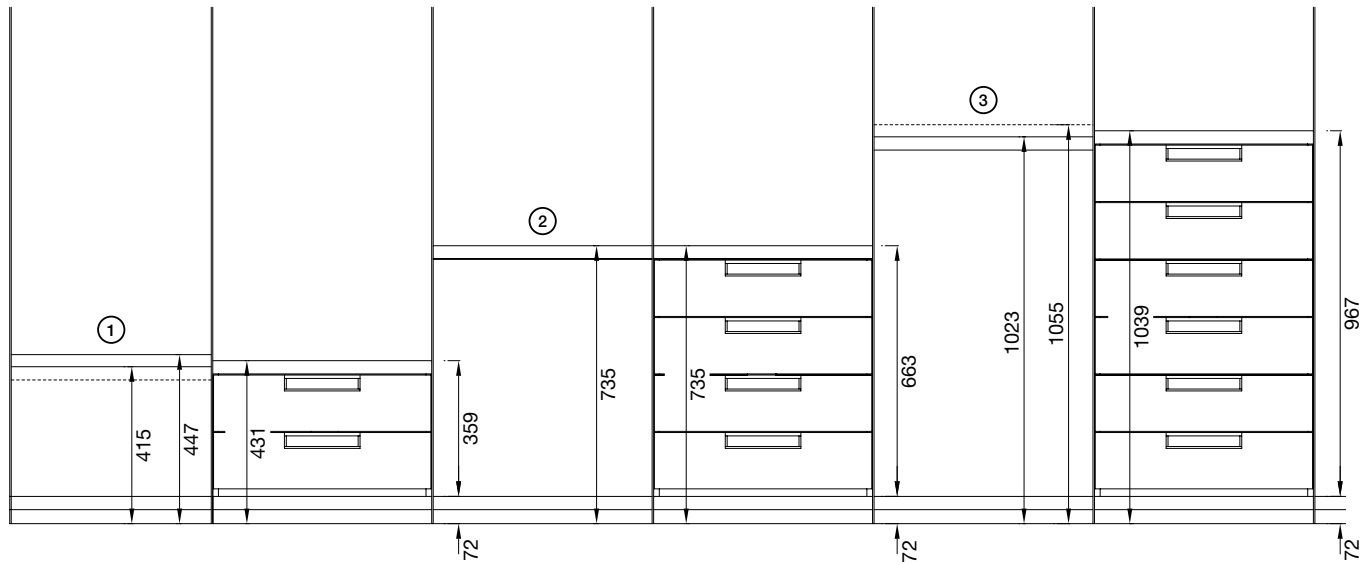

# Typology of shelf-supporting plates

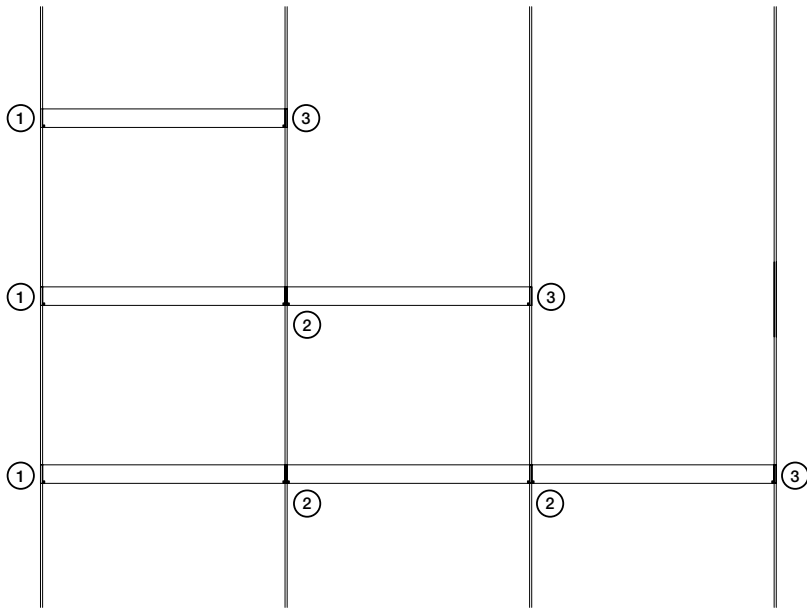

## Notes:

It is important to immediately define if the shelf is aligned with an other shelf or not, because the typology of rack change. If the position of the shelves (aligned or not) is changed during assembly, there will be racks missing.

### how ordered

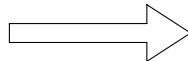
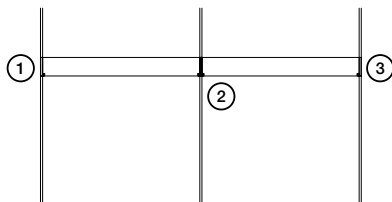

### changing during assembly

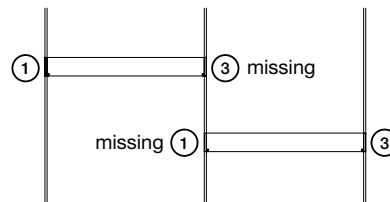

### how ordered

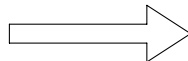
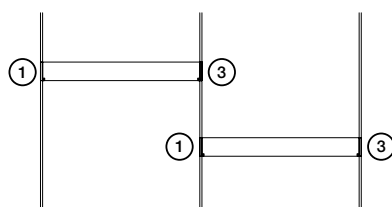

### changing during assembly

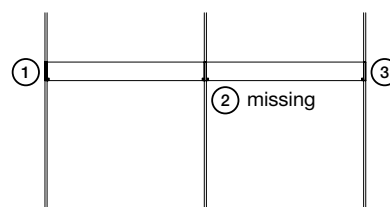

## Legenda

- 1 - Lateral left rack
- 2 - Central rack
- 3 - Lateral right rack

# Customizations: corner element

**Special processing (example with wider right side max. +161 mm)**  
 (available only for melamine elements)

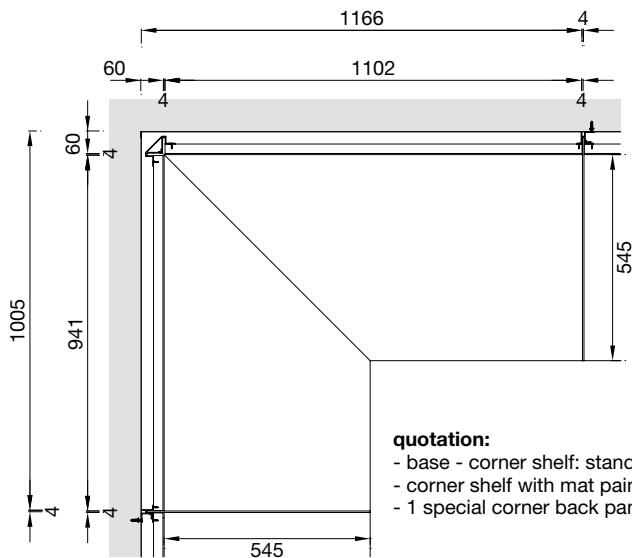

**quotation:**

- base - corner shelf: standard + € 115 surcharge
- corner shelf with mat painted front: standard + € 170 surcharge
- 1 special corner back panel (S9LN max width 1102) € 584 melamine
- € 1.035 melamine skin mat colours
- € 1.543 roller

**Corner walk-in closet with different depth (right side customized depth 400 / left side depth 545 standard)**

Cut example on a standard corner element

Dimensions on cut corner element

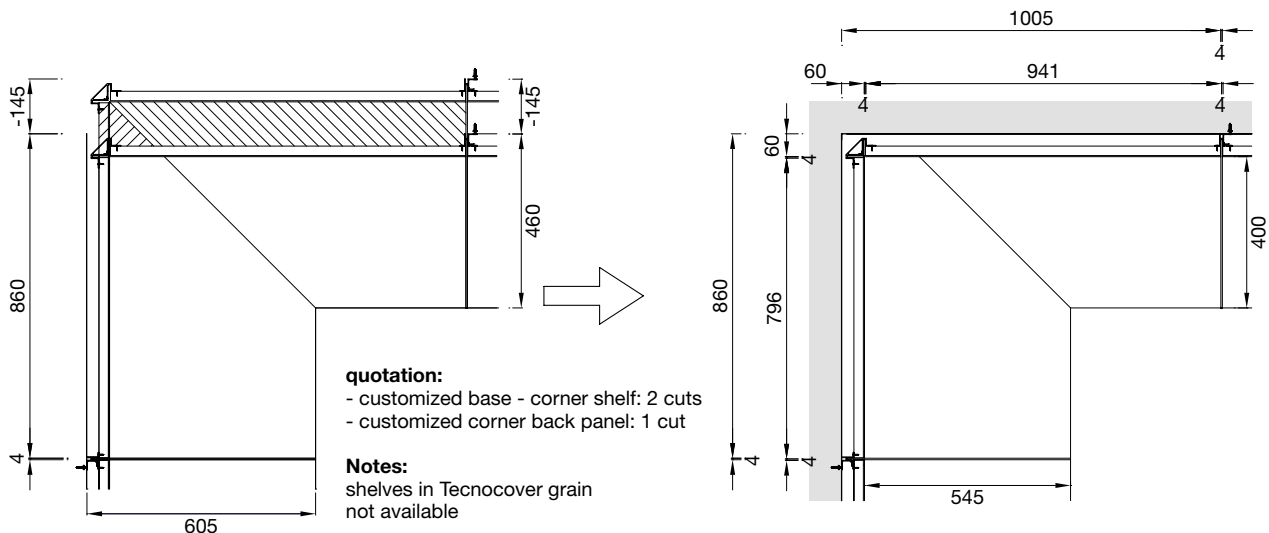

**quotation:**

- customized base - corner shelf: 2 cuts
- customized corner back panel: 1 cut

**Notes:**

shelves in Tecnocover grain  
 not available

# Customizations: corner element - back panel for inspection

## Corner walk-in closet with back pillar profiling

Cut example on a standard corner element

Dimensions on cut corner element

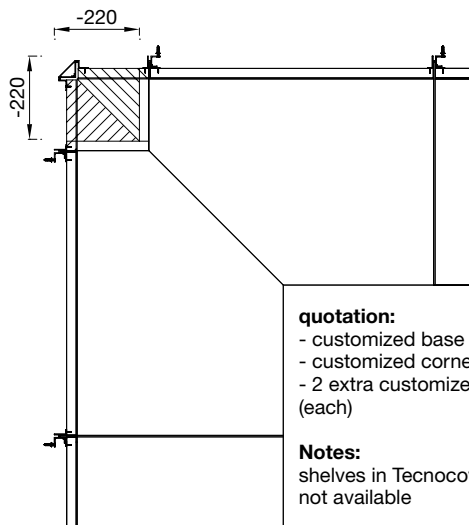

**quotation:**

- customized base - corner shelf: 2 cuts
- customized corner back panel: 2 cuts
- 2 extra customized back panels: 1 cut (each)

**Notes:**

shelves in Tecnocover grain not available

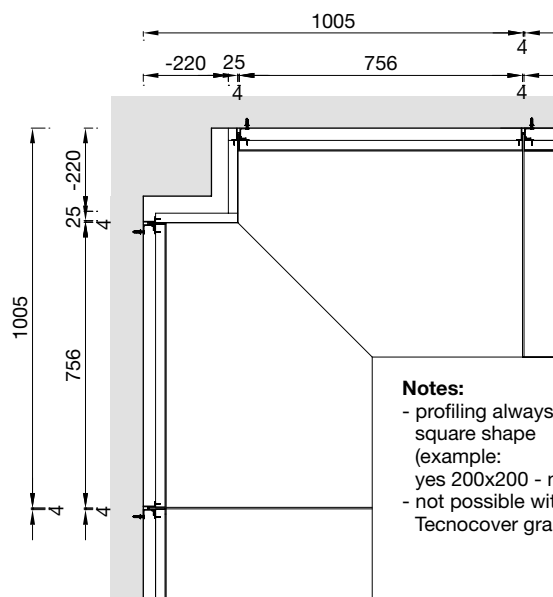

**Notes:**

- profiling always done in the square shape (example: yes 200x200 - no 200x250)
- not possible with shelves in Tecnocover grain

## Back panel for inspection

min. frame 100 mm. for each side

min. milling dimensions: height 350 width 250

opening panel th 25 mm with aligned hinge and built-in handle

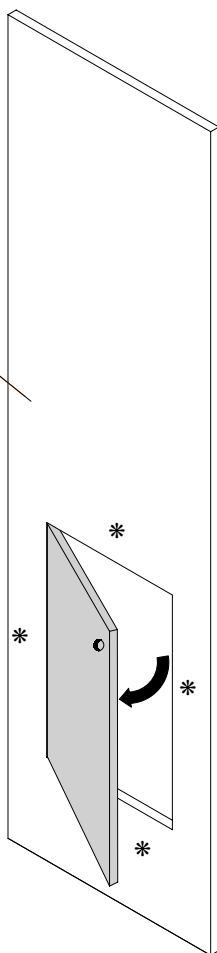

surcharge (processing + opening panel) to add to the back panel price: € 428 .

# Customizations: depth change

## Examples of depth change solutions

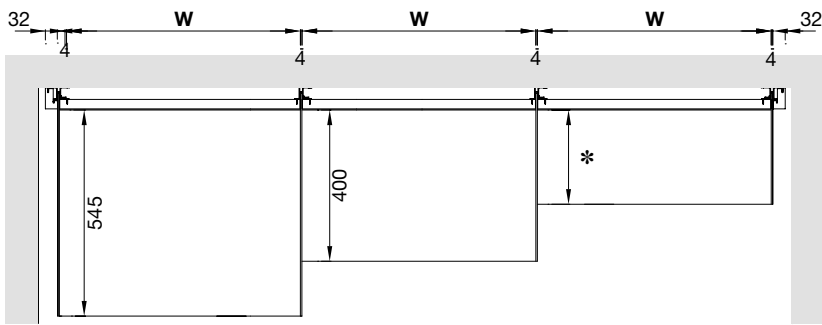

### How to manage:

- \* shelves customized in depth (for shelves see "Customizations" section)

## Modified walk-in closet for back central pillar

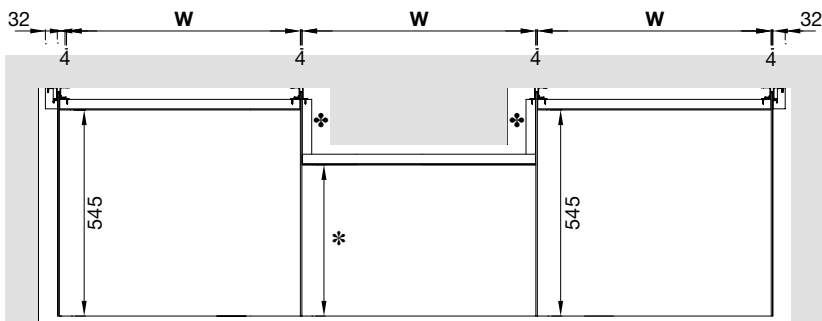

### How to manage:

- \* shelves customized in depth (for shelves see "Customizations" section)
- \* lamps cannot be inserted
- ✕ 1 extra customized back panel: +2 cuts to have partial panels

### Notes:

- not possible with:
  - glass / mirror back panels

# Customizations: mansard

## Examples of modified height solutions

different heights: standard linear cut

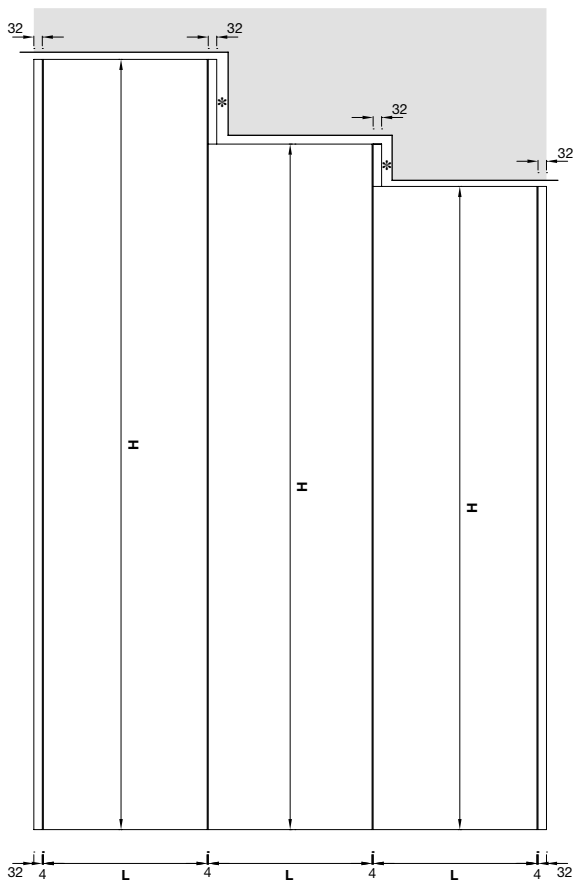

### How to manage:

- standard back panels with cut in height (1 cut)
- 1 extra PLE profile to have partial PL (\*)

## Examples of modified height solutions

different heights: inclined cut

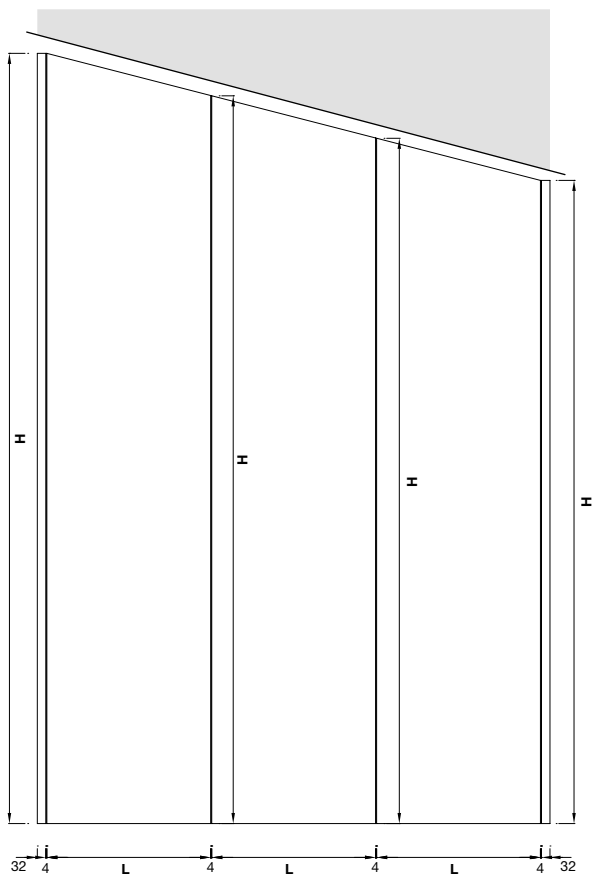

### Notes:

not possible with glass / mirror back panels

### How to manage:

- back panels cut in height (1 cut)

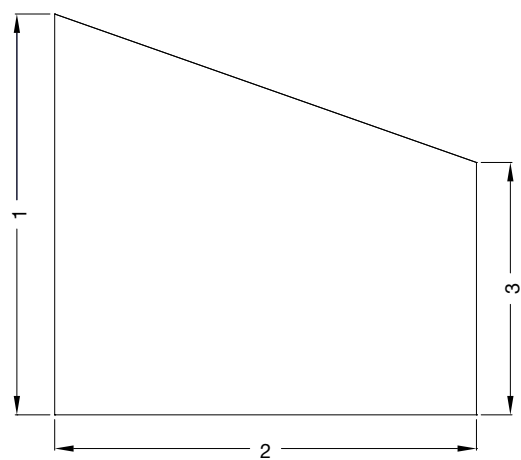

### Notes:

measurements verification required by our technical office, for compositions with inclined ceilings, communicate the following measures:

- 1 - wall left height
- 2 - wall width
- 3 - wall right height

# Customizations: change of height

## Central panel "below window"

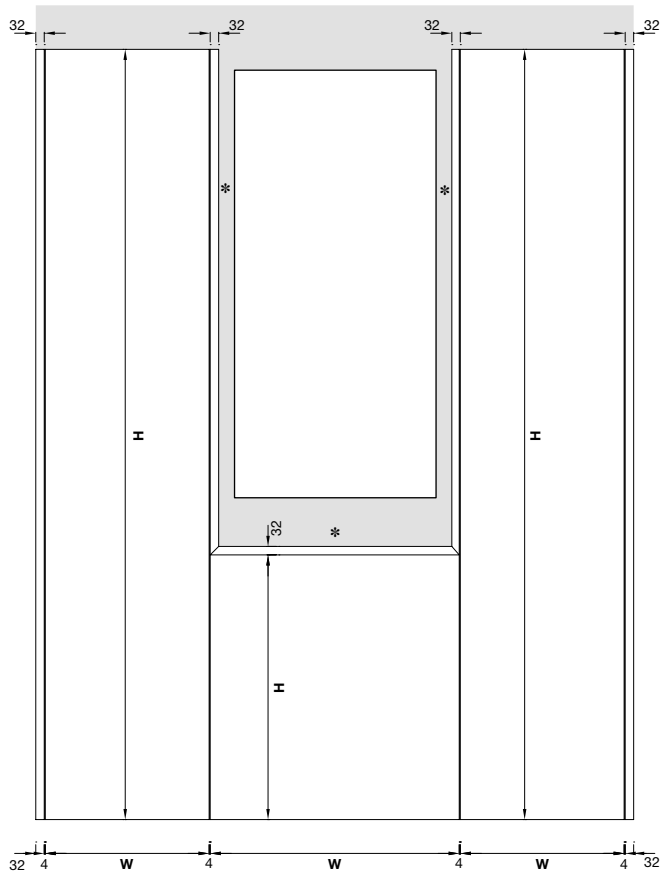

### How to manage:

- back panel with cut in height (1 cut)
- 3 PL profiles (\*):  
supplied as standard for 45° reduction and cut on site by customer

## Central panel "hanging"

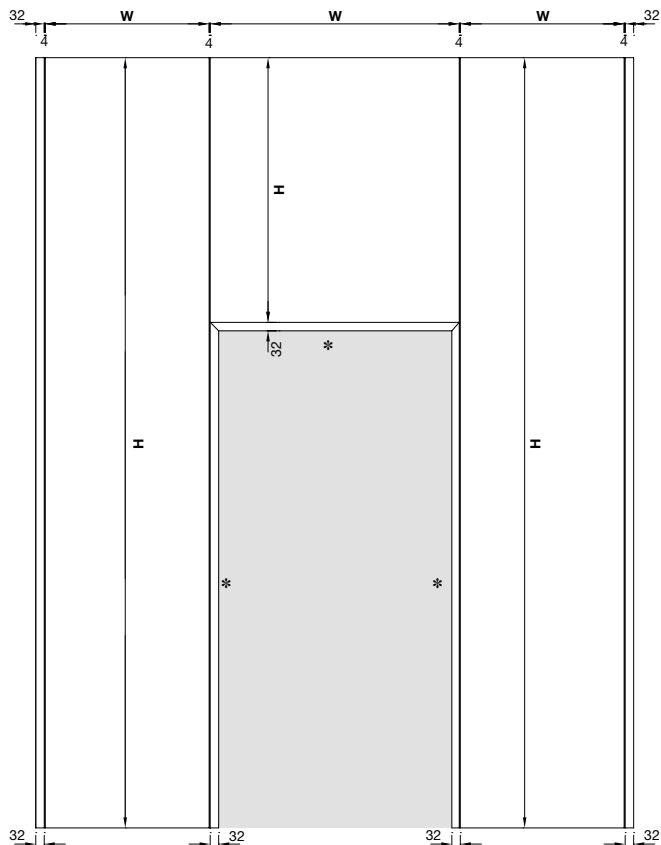

### How to manage:

- back panel with cut in height (1 cut)
- 3 PL profiles (\*):  
supplied as standard for 45° reduction and cut on site by customer



# Customizations: change of height

**Lateral panel on raised wall**

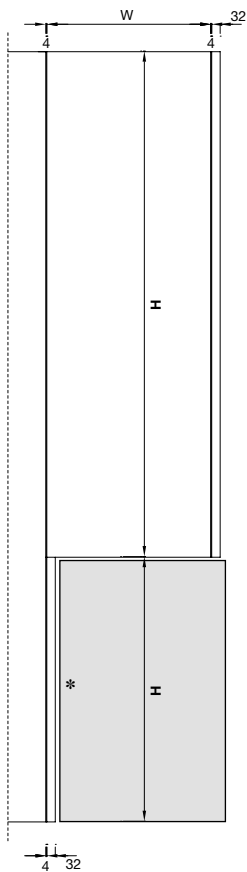

**How to manage:**  
 - back panel with cut in height (1 cut)  
 - 1 extra PLE profile to have partial PL (\*)

**Lateral panel "hanging"**

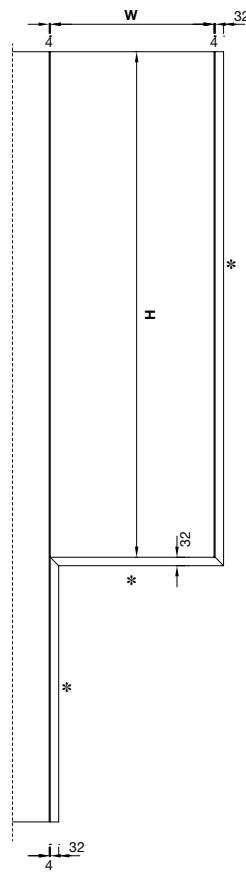

**How to manage:**  
 - back panel with cut in height (1 cut)  
 - 3 extra PL profile have partial PL (\*)  
 supplied as standard for 45° reduction and  
 4 cut on site by customer

**Back panel with shaping  
upper shaping**

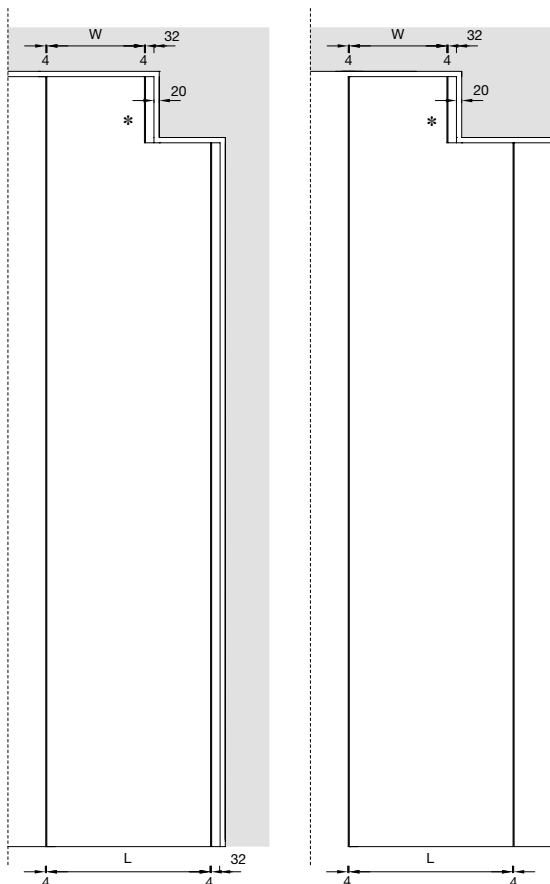

**lower shaping**

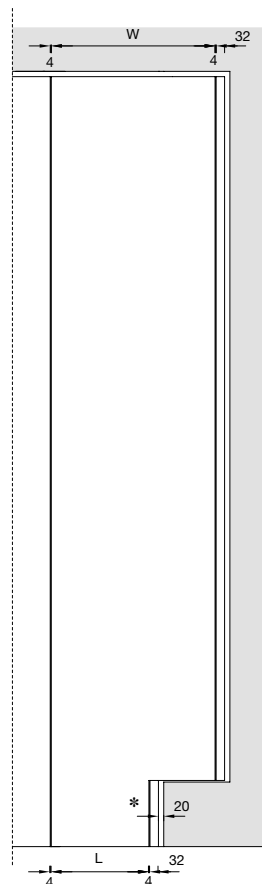

**How to manage:**  
 - back panel with shaping (2 cuts)  
 - 1 extra PL profile to have partial PL (\*)

**Notes:**  
 not possible with glass back panels / mirror

# Hanging rails and pull down hanging bars

## Hanging rails: positioning

walk-in closet Ubik d 605 standard

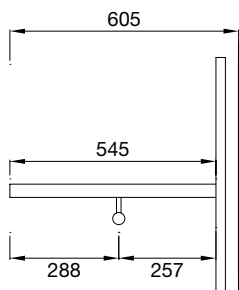

customized depth (ex. 531)

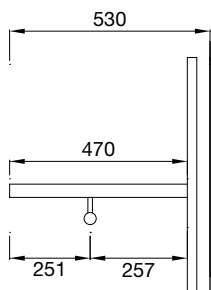

## hanging rail dimensions

hanging rail width:  
shelf width - 2

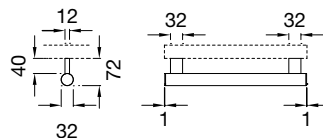

walk-in closet Ubik d 460 standard

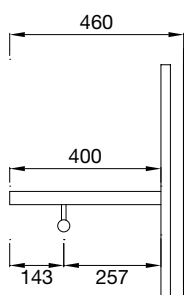

walk-in closet Ubik d 460 standard

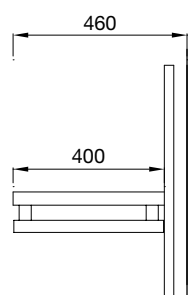

## Notes:

with walk-in closet d 460 standard or customized consider possible positioning of the hanging rail on the shelf depth (except for glass shelf)

## Pull down hanging bar

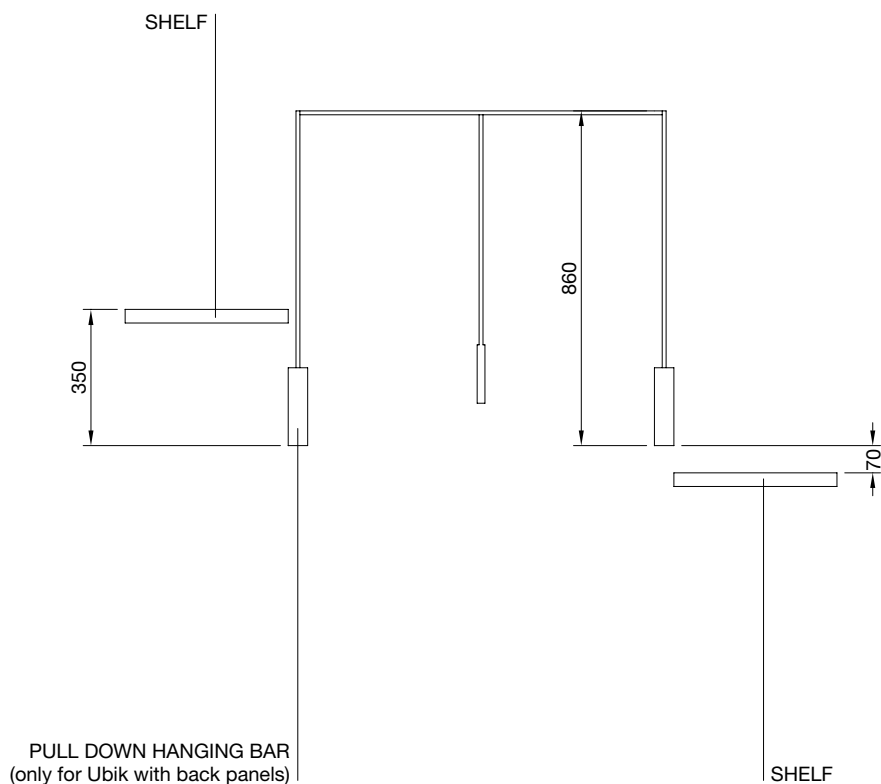

# Lighting system: scheme

Poliform remote control switching

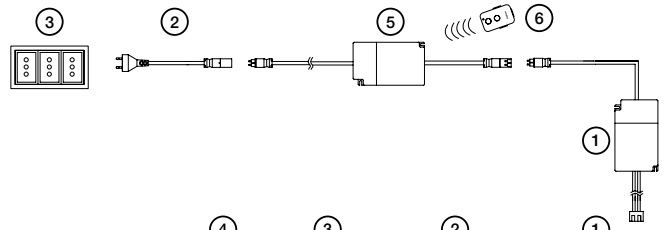

Wall switching

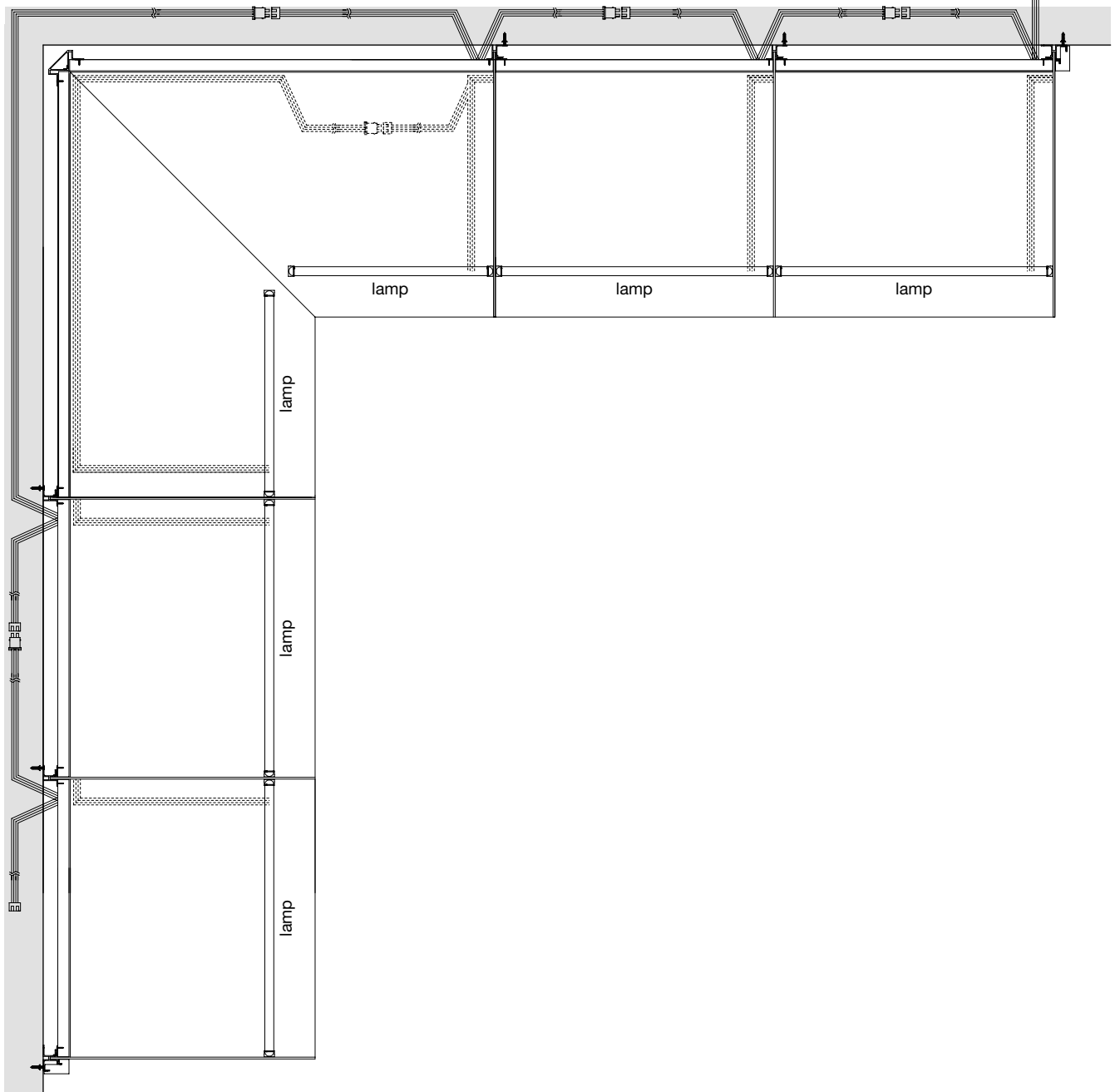
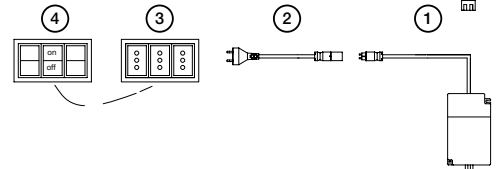

## Legenda

- 1 - power supply 30-70-150w (built-in on the back of the last back panel)
- 2 - plug
- 3 - electric socket
- 4 - wall switch
- 5 - remote control unit
- 6 - remote control

# Lighting system

## Electric system example

### Legenda:

-  shelf with LED
- E electrification (on the back panel)
- S shelf-supporting electrified plate

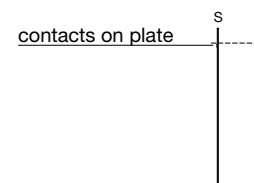
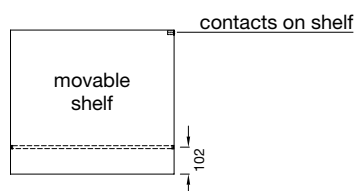
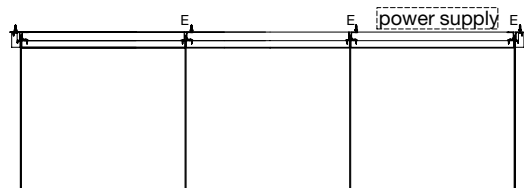
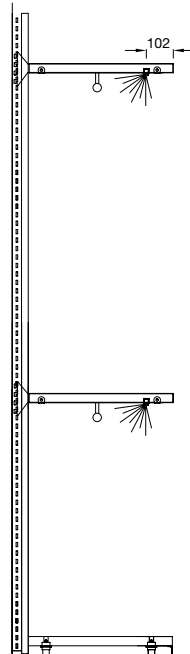
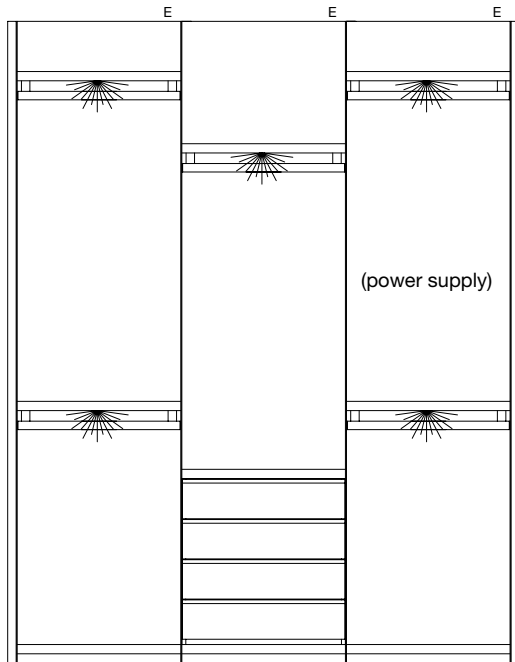

# Lighting system

Examples of after sale LED addition: elements to order

Ordered and delivered walk-in closet without LED

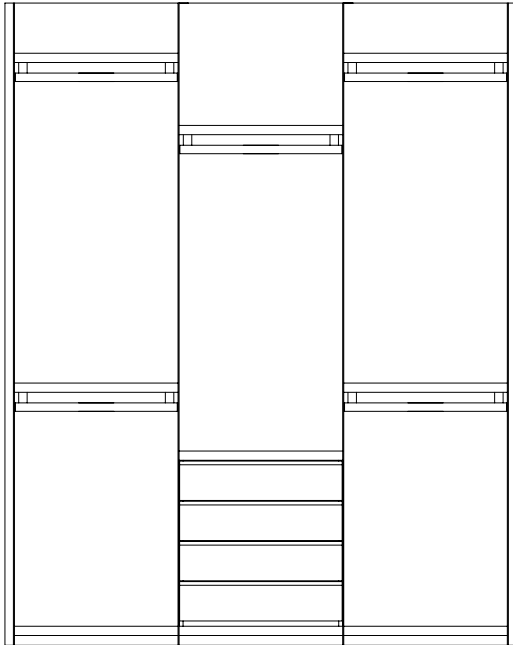

**elements to be ordered:**  
3 electrified back panels  
5 shelves with LED  
5 shelf-supporting electrified plates

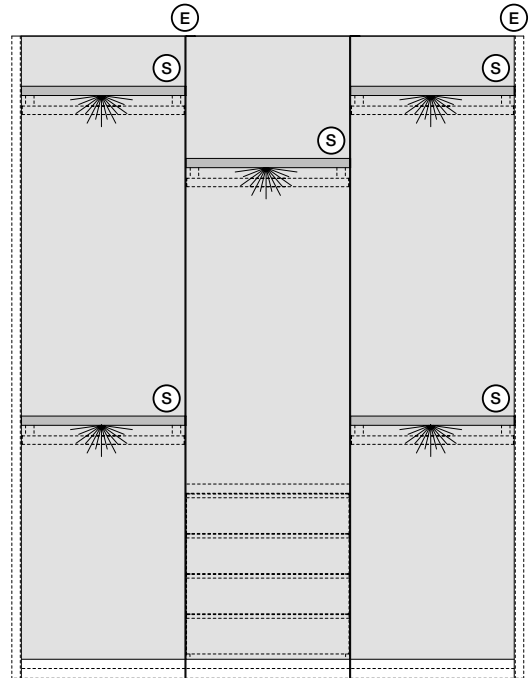
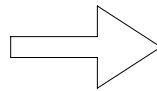

**elements to be ordered:**  
2 shelves with LED  
2 shelf-supporting electrified plates

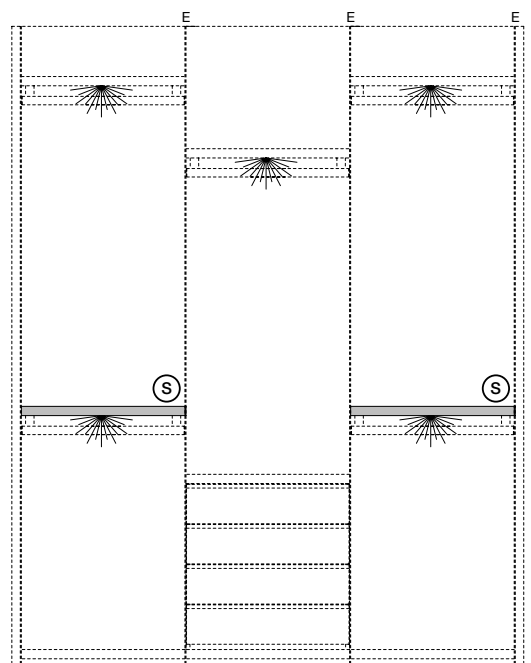
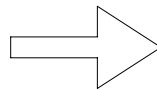
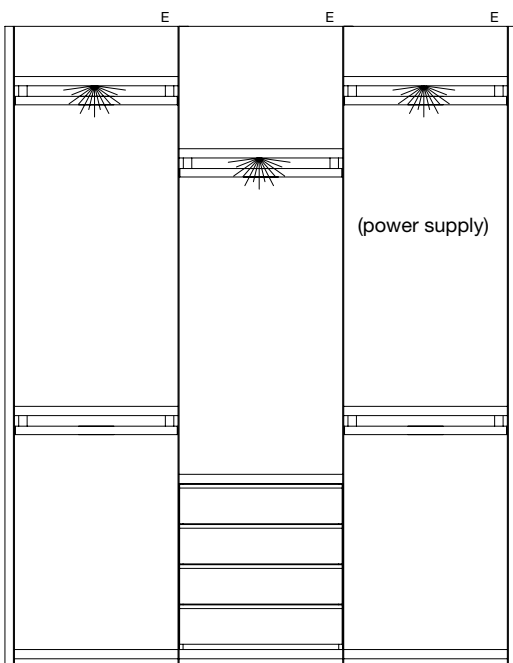

# Chest of drawers display case

## Standard solution:

the bottom of the chest of drawers display case element (\*) is aligned flush with the bottom of movable shelf or trousers hanger / tray / hanging or free-standing chest of drawers

**Notes:** not available for Ubik without back panel

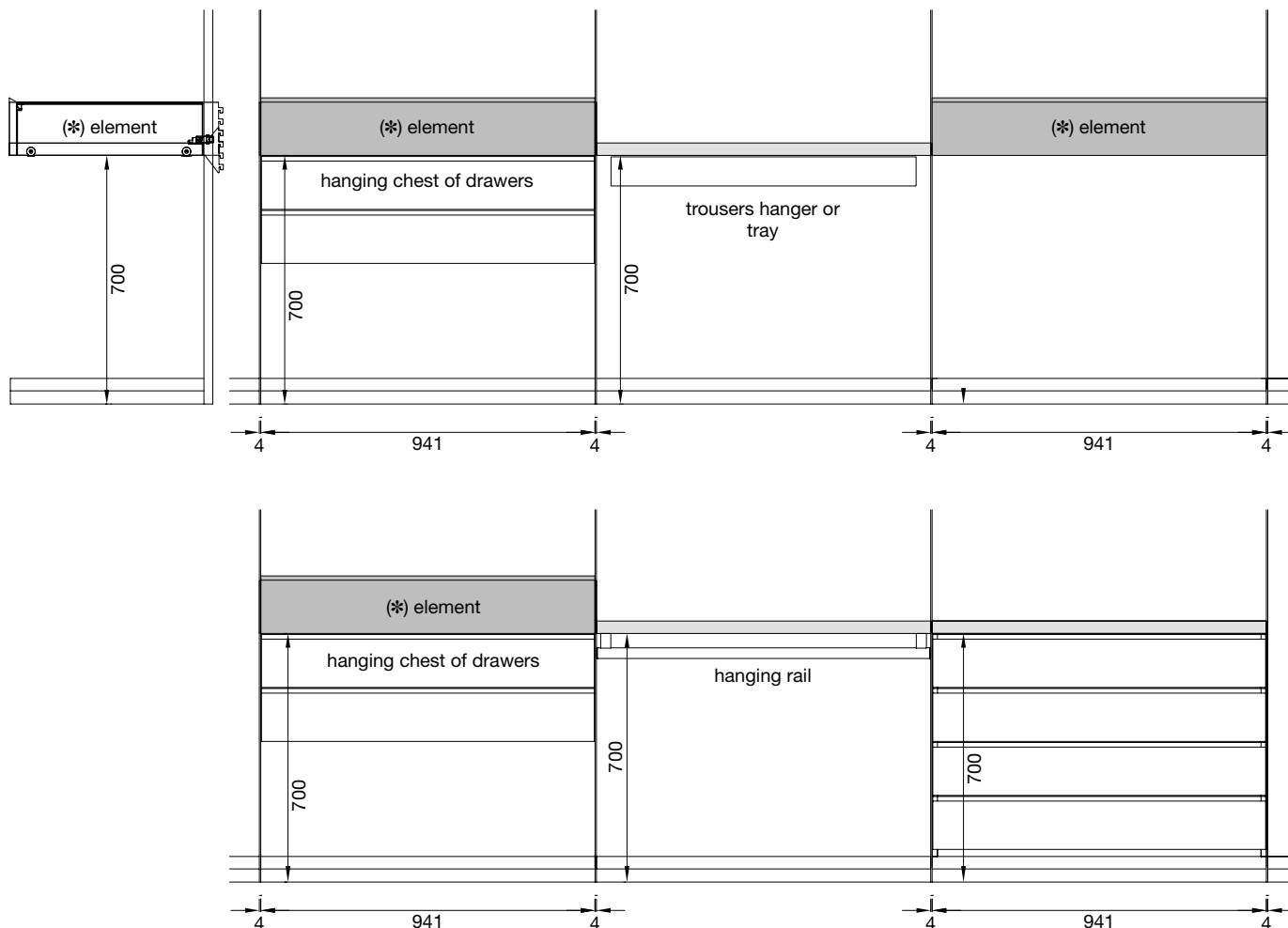

element dimensions: width 941 - depth 545 - height 162 / 150

inner dimensions of the pull-out drawer: width 855 - depth 500 - height 95

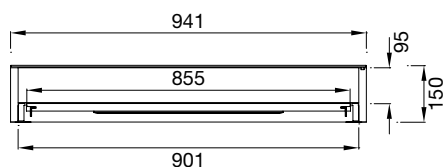
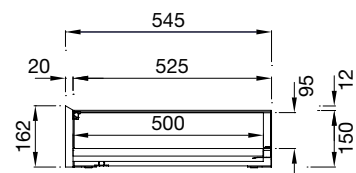

front for walk-in closet

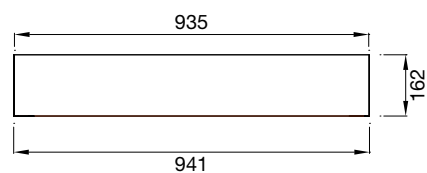

# Shirt storage

## Shirt storage

### 3 Elements

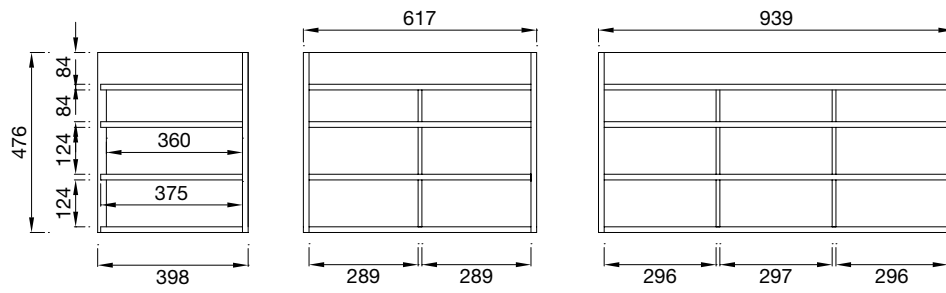

### 4 Elements

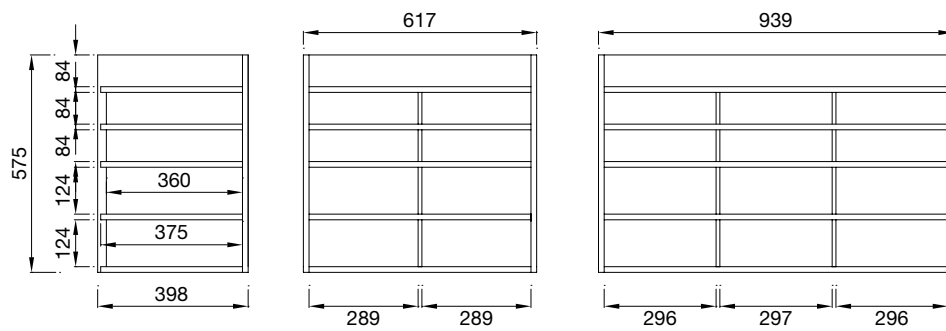

### Drawers

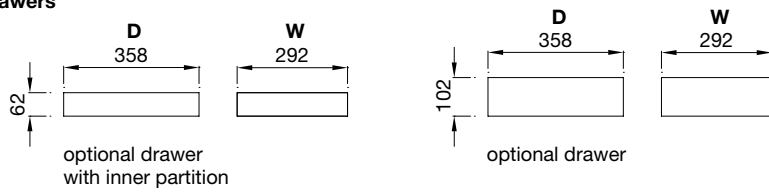

# Handbags storage - Shoes storage

## Handbags storage

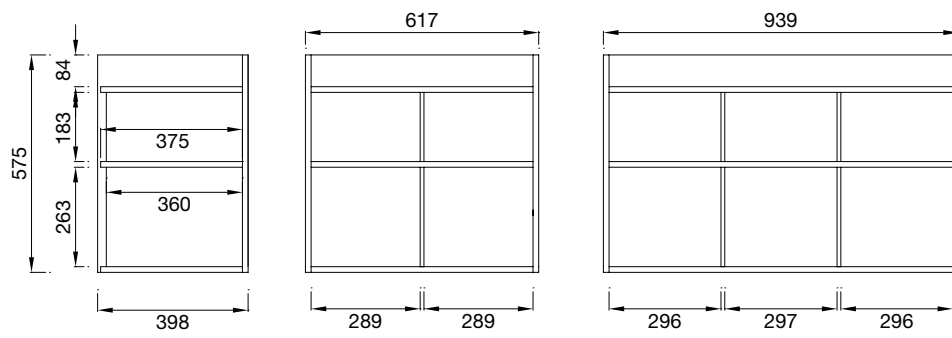

## Shoes storage

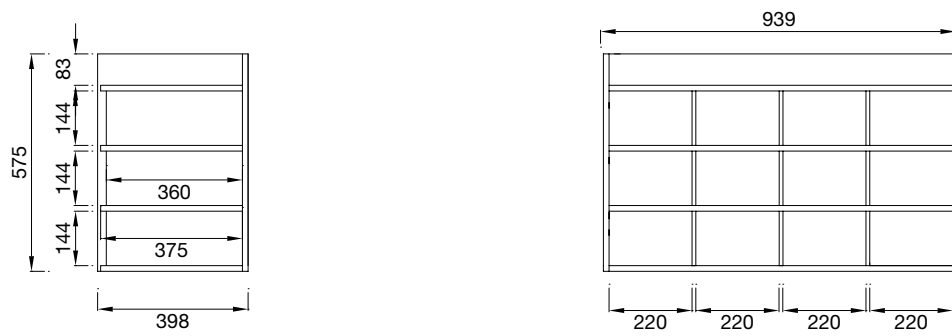

## Drawers

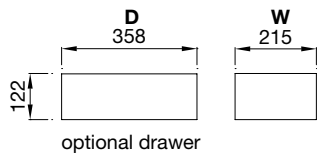



# Technical description of materials

## BACK PANEL

Structure	panel of wooden particles melamine
Thickness	25 mm
Edge	ABS
Features	supplied with profile in aluminium painted with rack for shelves fixing. Adjustable feet.

## SKIN BACK PANEL

Structure	panel of wooden particles melamine mat lacquer
Thickness	25 mm
Features	supplied with profile in aluminium painted with rack for shelves fixing. Adjustable feet.

## ROLLER BACK PANEL

Material	panel of wooden particles melamine with methacrylate
Thickness	25 mm
Features	supplied with profile in aluminium painted with rack for shelves fixing. Adjustable feet.

## GLASS BACK PANEL

Structure	panel of wooden particles with glass or mirror applied
Thickness	25 mm
Features	supplied with profile in aluminium painted with rack for shelves fixing. Adjustable feet.

## SHELF

### CHEST OF DRAWERS TOP IN MELAMINE

Material	panel of wooden particles melamine
Edge	ABS
Thickness	35 mm
Features	supplied with iron plates painted for back panel fixing.

## SHELF

### CHEST OF DRAWERS TOP IN MELAMINE WITH FRONT

Material	panel of wooden particles melamine
Thickness	35 mm
Lateral edge	ABS
Front	aluminium painted
Features	supplied with iron plates painted for back panel fixing.

## SHELF

### CHEST OF DRAWERS TOP IN TECNOCOVER GRAIN WITH FRONT

Material	panel of wooden particles melamine
Finitura	Tecnocover grain
Thickness	35 mm
Front	aluminium painted
Features	supplied with iron plates painted for back panel fixing.

## SHELF

### CHEST OF DRAWERS TOP IN TECNOCOVER GRAIN WITH FRAME

Material	panel of wooden particles melamine
Finitura	Tecnocover grain
Thickness	shelf 35 mm
Frame	aluminium painted
Features	supplied with iron plates painted for back panel fixing.

## GLASS SHELF

### GLASS WITH LIGHT

Material	tempered fumé glass
Thickness	shelf 35 mm - glass 4 mm
Frame	aluminium painted
Features	supplied with iron plates painted for back panel fixing.

## BASE

Material	panel of wooden particles melamine
Edge	ABS
Thickness	35 mm
Features	supplied with plinth in aluminium painted and adjustable feet.

## CHEST OF DRAWERS STRUCTURE

Material	panel of wooden particles melamine
Thickness	8/15/25 mm
Edge	ABS
Features	also available with casters

## DRAWER FRONT

Material	panel of wooden particles melamine
Thickness	20 mm
Edge	ABS
Features	TRACK handle in aluminium painted - STEP handle (optional)

## GLASS DRAWER FRONT

Material	fumé reflective glass
Thickness	4 mm
Frame	birch plywood melamine
Features	handle in aluminium painted

## ROLLER DRAWER FRONT

Material	panel of wooden particles melamine with methacrylate
Thickness	25 mm
Edge	ABS

## TROUSERS HOLDER

Front	panel of wooden particles melamine
Edge	ABS
Sides	medium density panel melamine
Back panel	panel in solid wood with melamine
Features	can be equipped with a trouser holder / tray with partition elements.

## DRAWER STRUCTURE

Material	panel of wooden particles melamine
Thickness	14 mm sides, 14 mm back panel and 6 mm bottom
Edge	ABS
Features	metal runners with ball bearings and soft closing

## TRAY

Front	solid wood faced with melamine
Bottom	panel of wooden particles melamine
Sides	panel of wooden particles melamine
Edge	ABS
Features	the "shoes holder" option is supplied with painted small bars

## SHIRT HOLDER

## BAG HOLDER

## SHOE HOLDER

Structure	panel of wooden particles melamine
Shelves	panel of wooden particles melamine or Tecnocover grain
Thickness	15 mm
Edge	ABS
Features	also available with drawers

## HANGING CHEST OF DRAWERS WITH GLASS TOP

Structure	panel in medium density fibre faced with melamine
Fronts	panel in medium density fibre faced with melamine lacquer
Top	fumé glass with silkscreen
Features	drawers bottom coated with Tecnocover grain equipped with inner light

## Allowances for assembly in width

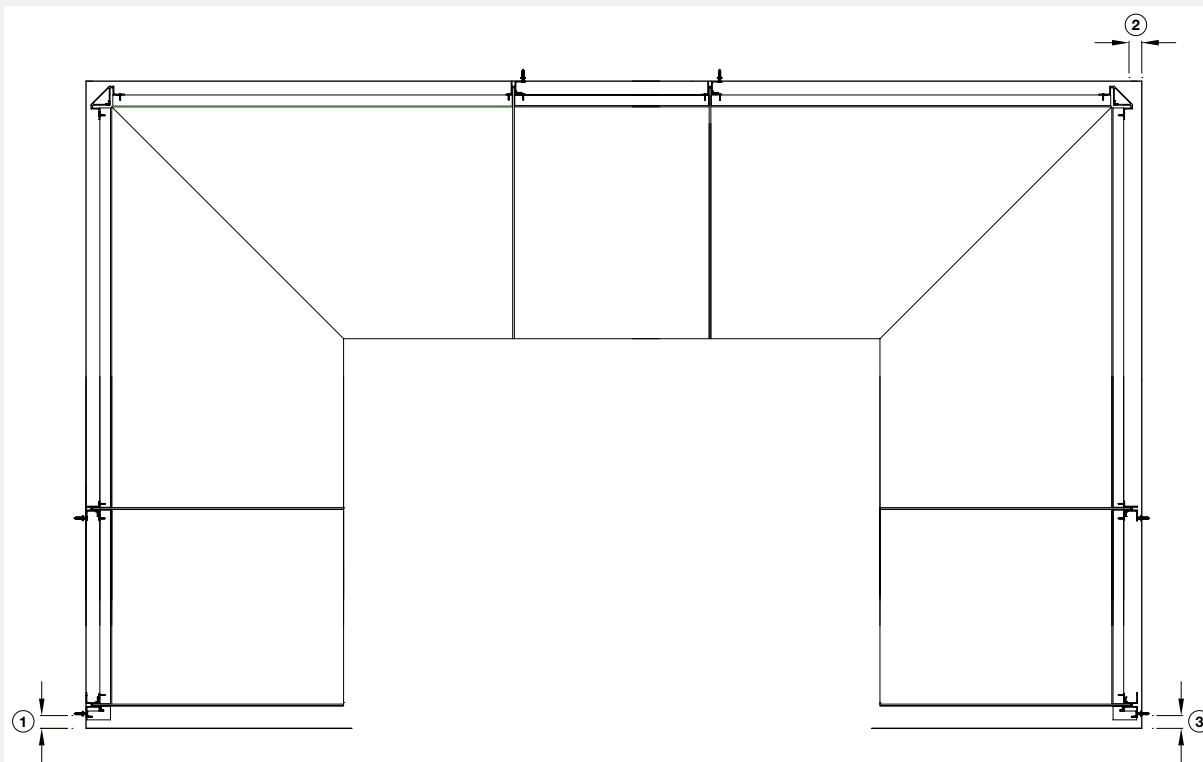

① ③ - min. 20 mm.

② - min. 10 mm.

Allowances for assembly in height  
A space greater than 20 mm is required.



# Structural elements

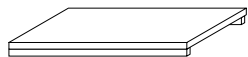

## BASE

### melamine:

- Canvas grigio
- Canvas beige
- Ardesia
- Spessart oak
- Cenere oak
- C. walnut
- Elm

### plinth

- Ardesia
- Champagne

## SHELF-SUPPORTING PLATES PROFILE WITH RACK (UBIK WITHOUT BACK PANELS):

- Ardesia
- Champagne

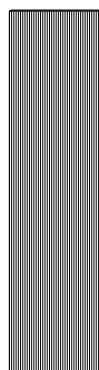
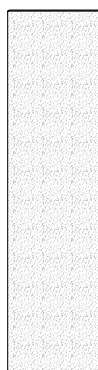

## BACK PANEL LATERAL PROFILE ADJUSTING FILLER SPECIAL END FILLER

### melamine:

- Canvas grigio
- Canvas beige
- Ardesia
- Spessart oak
- Cenere oak
- C. walnut
- Elm

## SKIN BACK PANEL LATERAL PROFILE ADJUSTING FILLER SPECIAL END FILLER

melamine mat lacquer colours

## SPECIAL ROLLER BACK PANEL LATERAL PROFILE ADJUSTING FILLER SPECIAL END FILLER

- ardesia
- latte

## GLASS BLACK PANEL

- mirror bianco 4000

### - glossy glass:

- bianco extralight 2201
- grafite 1204
- nero 1203
- canapa 1235
- ghiaccio 2273
- arena 1264

### - etched glass:

- titanio 5325
- bronzo 5323
- acciaio 5380

# Inner equipment



## SHELVES CHESTS OF DRAWERS TOPS IN MELAMINE

### SHELVES/TOPS:

- Canvas grigio
- Canvas beige
- Ardesia
- Spessart oak
- Cenere oak
- C. walnut
- Elm



## SHELVES CHESTS OF DRAWERS TOPS WITH FRONT

### PAINTED FRONT:

- Ardesia
- Champagne

### SHELVES/TOPS:

#### melamine:

- Canvas grigio
- Canvas beige
- Ardesia
- Spessart oak
- Cenere oak
- C. walnut
- Elm



## SHELVES CHESTS OF DRAWERS TOPS WITH FRAME

### PAINTED FRAME:

- Ardesia
- Champagne

### SHELVES/TOPS:

#### Tecnocover grain:

- 01 elefante
- 02 moro
- 05 latte
- 06 nocciola

#### glass

(not available for chest of drawers top):  
3050 fumé glass



## HANGING RAIL

- Ardesia
- Champagne



## HANGING RAIL COATED

### HANGING RAILS SUPPORTING - SIDE CLOSING CAPS:

- Ardesia
- Champagne

### HANGING BAR:

#### Tecnocover grain:

- 01 elefante
- 02 moro
- 05 latte
- 06 nocciola

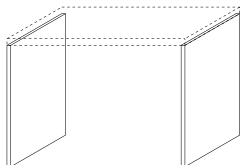

## FREESTANDING/HANGING CHESTS OF DRAWERS STRUCTURE

### melamine:

- Canvas grigio
- Canvas beige
- Ardesia
- Spessart oak
- Cenere oak
- C. walnut
- Elm

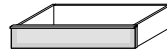
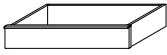

**CHEST OF DRAWERS FRONTS**

**LOW DRAWER**

**melamine:**

- Canvas grigio
- Canvas beige
- Ardesia
- Spessart oak
- Cenere oak
- C. walnut
- Elm

**CHEST OF DRAWERS FRONTS**

**ROLLER LOW DRAWER**

- ardesia
- latte

**CHEST OF DRAWERS FRONTS**

**GLASS DRAWER**

5059 fumé reflective

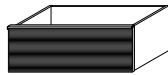
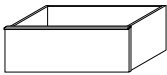

**CHEST OF DRAWERS FRONTS**

**HIGH DRAWER**

**melamine:**

- Canvas grigio
- Canvas beige
- Ardesia
- Spessart oak
- Cenere oak
- C. walnut
- Elm

**CHEST OF DRAWERS FRONTS**

**ROLLER HIGH DRAWER**

- ardesia
- latte

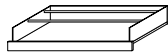
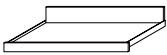

**CHEST OF DRAWERS FRONTS**

**TRAY**

**melamine:**

- Canvas grigio
- Canvas beige
- Ardesia
- Spessart oak
- Cenere oak
- C. walnut
- Elm

**CHEST OF DRAWERS FRONTS**

**SHOE TRAY**

**melamine:**

- Canvas grigio
- Canvas beige
- Ardesia
- Spessart oak
- Cenere oak
- C. walnut
- Elm

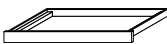

**TRAYS FRONTS**

**TRAY**

**melamine:**

- Canvas grigio
- Canvas beige
- Ardesia
- Spessart oak
- Cenere oak
- C. walnut
- Elm

**TRAYS FRONTS**

**ROLLER TRAY**

- ardesia
- latte

**BOTTOM**

- Tecnocover grain colours

**TRAYS FRONTS**

**TROUSERS HOLDER**

**melamine:**

- Canvas grigio
- Canvas beige
- Ardesia
- Spessart oak
- Cenere oak
- C. walnut
- Elm

**TRAYS FRONTS**

**ROLLER TROUSERS HOLDER**

- ardesia
- latte

**BOTTOM**

- Tecnocover grain colours

# Modularity

## Notes:

total widths with PL lateral 2 profiles width 32 mm

