

MARTEEN — VINCENT VAN DUYSSEN 2021

1—
8



The Marteen is a multifunctional seating and storage system introducing harmony with perfectly balanced volumes, in an alternation of solids and voids.



This symbol shows that the product has removable upholstery. Only qualified personnel can remove the upholstery of some of our products. If this information is pertinent, it will be included in the warnings section.



This symbol shows that the product is available on request in a fire resistant version that complies with the standards BS 5852 and TB 117-2013. The buyer is responsible for checking to make sure that the product is suitable and compliant with the requirements for the designated use and the current applicable laws and standards for the destination and use of the product.

FINISHES

BASE FINISHES

painted pewter colour

TECHNICAL INFORMATION

INTERNAL STRUCTURE

Frame made of solid Firwood (*Picea abies*) and wood particle panels with elastic straps.

STRUCTURE PADDING

High performance variable density polyurethane foam. Cover in bonded velveteen.

BACK CUSHIONS

Solotex. 100% cotton cover.

BASE

Feet in painted hot-welded steel with non-slip plastic ferrules.

REMOVABLE OUTER COVER

(See enclosed sheet, specific for the cover in question).

MODULES WITH DRAWER

Top: Honeycombed panel covered with an Oak (*Quercus*) or Eucalyptus (*Eucalyptus globulus*) wood veneer;
Drawer: Folded and matt lacquered medium-density fibre panel; structure reinforced with metal plates.

SMALL TABLES WITH DRAWER

Top: Honeycombed panel covered with an Oak (*Quercus*) or Eucalyptus (*Eucalyptus globulus*) wood veneer;
Drawer: Folded and matt lacquered medium-density fibre panel; structure reinforced with metal plates.
Base: Wood particle panel, matt lacquered.

SMALL TABLES

Top: Honeycombed panel covered with an Oak (*Quercus*) or Eucalyptus (*Eucalyptus globulus*) wood veneer;
Base: Laminate-faced, matt lacquered honeycombed panel.



AVAILABLE IN FIRE-RESISTANT
VERSION TB117 AND BS5852

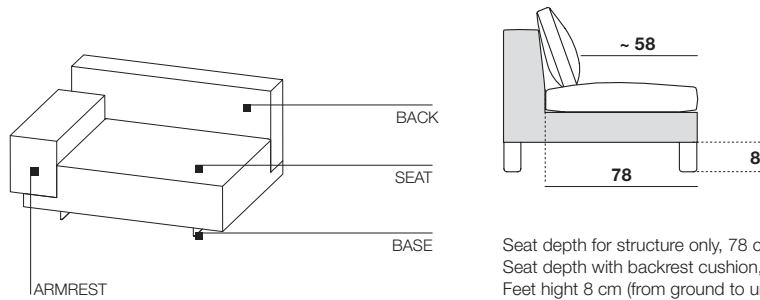

MODULES WITH DRAWER

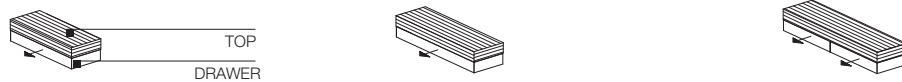

SMALL TABLES WITH DRAWER

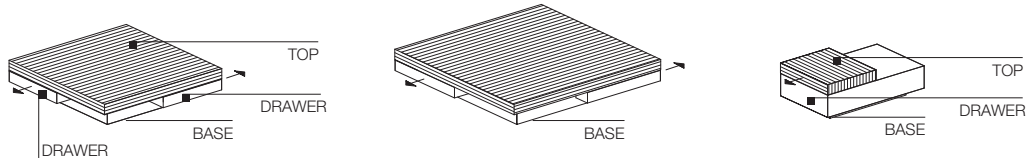

SMALL TABLES

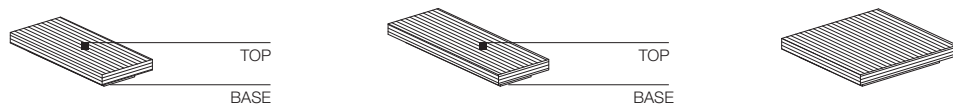

NOTES

For correct ergonomics and maximum comfort, it is advisable to design each module using one or more back cushions, according to the sizes proposed in the price list.

In addition to correct ergonomics, the presence of these elements gives the product a complete and elegant appearance.

When ordering

Specify the type and the number of backrests.

DIMENSIONS

end element with low armrest

TEB128 dx - sx

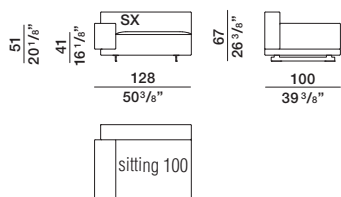

end element with drawer

TEC128 dx - sx

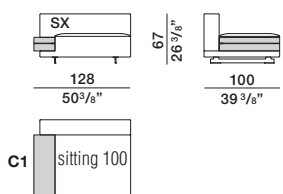

corner end element

TEA120 dx - sx

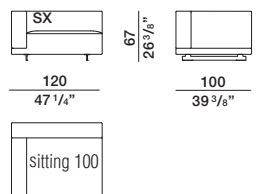

end element with low armrest

TEB108 dx - sx

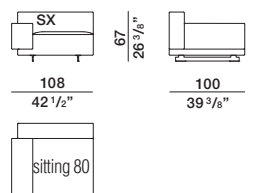

end element with drawer

TEC108 dx - sx

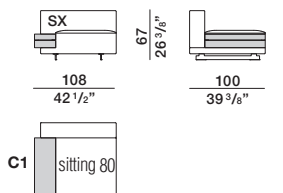

corner end element

TEA100 dx - sx

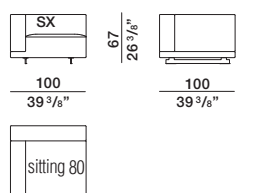

back cushion

CS80/50

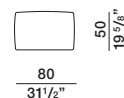

back cushion

CS10/50

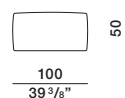

back cushion

CS80/36

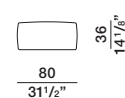

back cushion

CS10/36

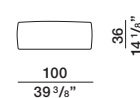

back cushion

CS80/50

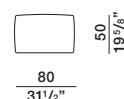

back cushion

CS10/50

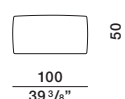

back cushion

CS80/36

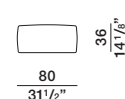

back cushion

CS10/36

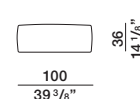

back cushion

CS80/50

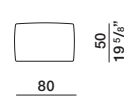

back cushion

CS10/50



back cushion

CS80/36

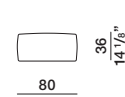

back cushion

CS10/36

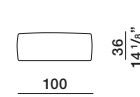

back cushion

CS60/50

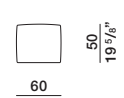

back cushion

CS80/50

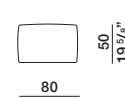

back cushion

CS60/36

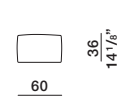

back cushion

CS80/36

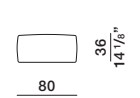

back cushion

CS60/50

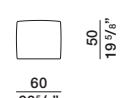

back cushion

CS80/50

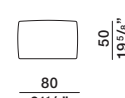

back cushion

CS60/36

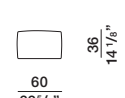

back cushion

CS80/36

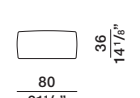

back cushion

CS60/50

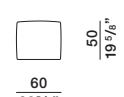

back cushion

CS80/50

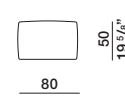

back cushion

CS60/36

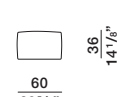

back cushion

CS80/36

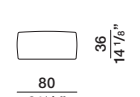

DIMENSIONS

central element

CEN120

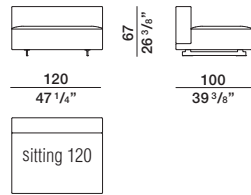

seat with drawer

CEC120

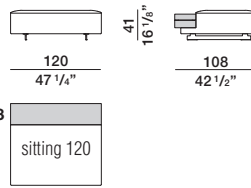

C3

back cushion

CS10/50

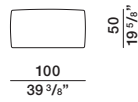

back cushion

CS60/50

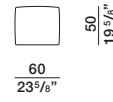

back cushion

CS10/36

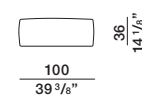

back cushion

CS60/36

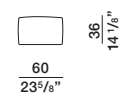

central element

CEN100

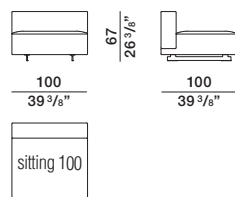

seat with drawer

CEC100

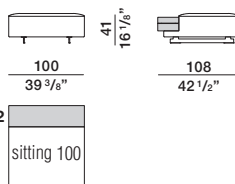

C2

back cushion

CS80/50

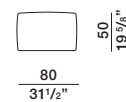

back cushion

CS10/50

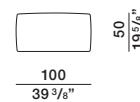

back cushion

CS80/36

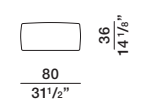

back cushion

CS10/36

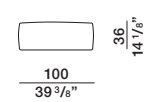

central element

CEN080

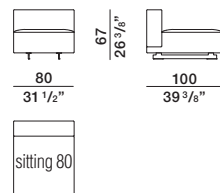

seat with drawer

CEC080

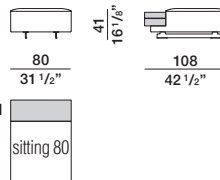

C1

back cushion

CS60/50

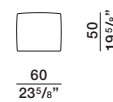

back cushion

CS80/50

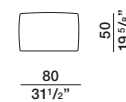

back cushion

CS60/36

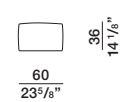

back cushion

CS80/36

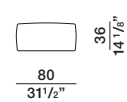

DIMENSIONS

low armrest island

ISB128 dx - sx

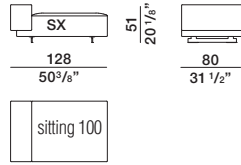

island with drawer

ISC128 dx - sx

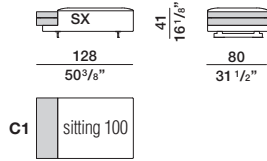

low armrest island

ISB108 dx - sx

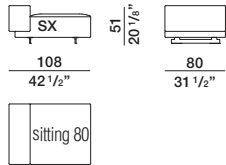

island with drawer

ISC108 dx - sx

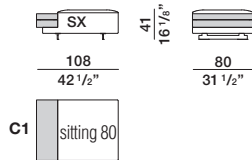

chaise longue with low armrest

CLB128 dx - sx

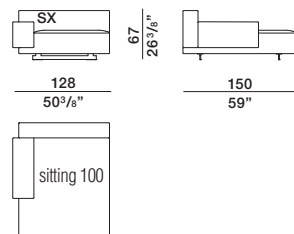

chaise longue with drawer

CLC128 dx - sx

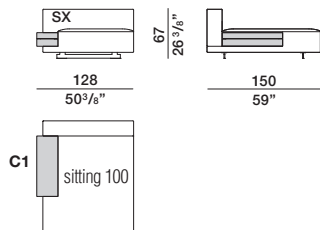

back cushion

CS80/50

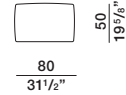

back cushion

CS10/50

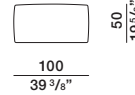

back cushion

CS80/36

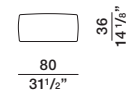

back cushion

CS10/36

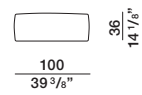

back cushion

CS80/50

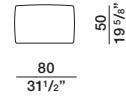

back cushion

CS10/50

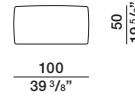

back cushion

CS80/36

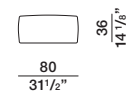

back cushion

CS10/36

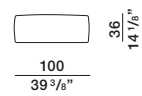

back cushion

CS60/50

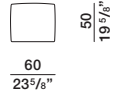

back cushion

CS80/50

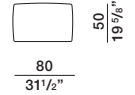

back cushion

CS60/36

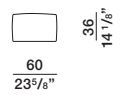

back cushion

CS80/36

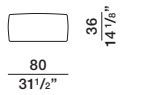

back cushion

CS60/50

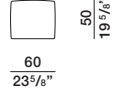

back cushion

CS80/50

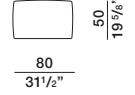

back cushion

CS60/36

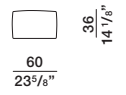

back cushion

CS80/36

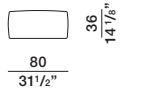

back cushion

CS80/50

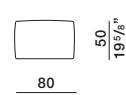

back cushion

CS10/50

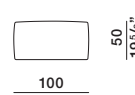

back cushion

CS80/36

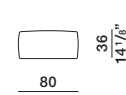

back cushion

CS10/36

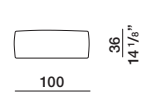

back cushion

CS80/50

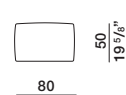

back cushion

CS10/50

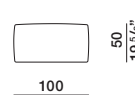

back cushion

CS80/36

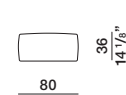

back cushion

CS10/36

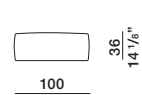

DIMENSIONS

daybed DBE100

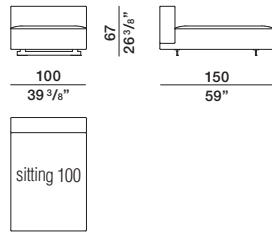

back cushion CS80/50

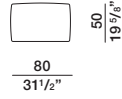

back cushion CS10/50

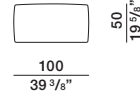

back cushion CS80/36

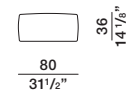

back cushion CS10/36

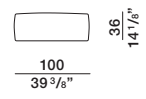

pouf PF12/10

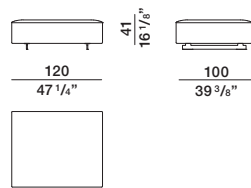

PF10/10

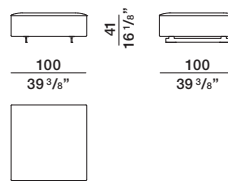

pouf PF60/10

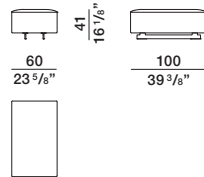

PF10/80

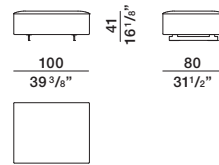

pouf PF80/80

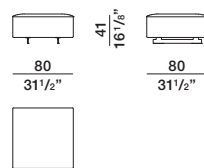

ornamental cushion PCU90/75

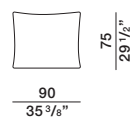

ornamental cushion CF48

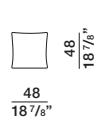

FINISHES

DRAWERS
AND BASE FINISH
pewter colour lacquered

TOP FINISHES

eucalyptus
thermo oak

ATTENTION:

► The modules with drawers (C1-C2-C3) can not ordered individually, but only in combination with the modules provided as per the price list

► No reductions of any kind are possible

DIMENSIONS

**C1
module with 1 drawer**

CAS1

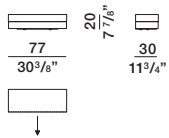

small table

TAV1

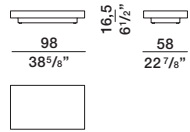

small table with 2 drawers

TAC2

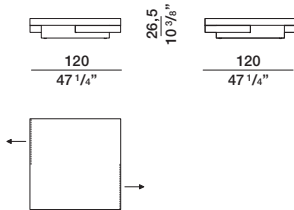

**C2
module with 1 drawer**

CAS2

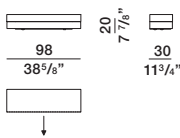

small table

TAV2

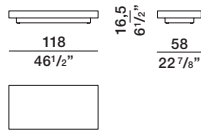

small table with 2 drawers

TAC3

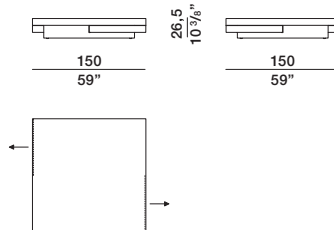

**C3
module with 2 drawers**

CAS3

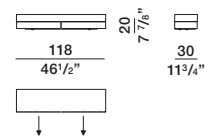

small table

TAV3

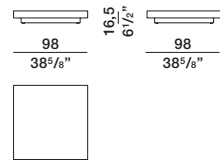

small table with 1 drawer

TAC1

