

Wireflow

Design by Arik Levy

Crafted of black, electrical cables, Volumetric's airy, three-dimensional outline lends it the feeling of being at once present and absent. The geometric volumes are tipped with LED light terminals in a contemporary take on the traditional chandelier.

Pendant

4 LEDs

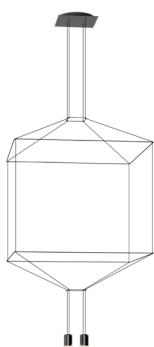

0309
100 x 100 cm

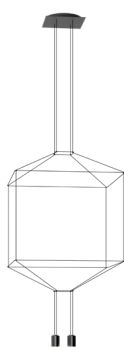

0310
80 x 80 cm

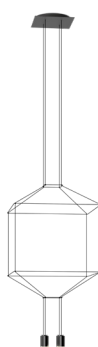

0311
64 x 64 cm

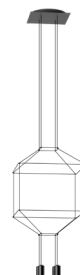

0312
50 x 50 cm

8 LEDs

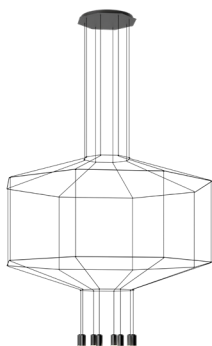

0299
150 x 150 cm

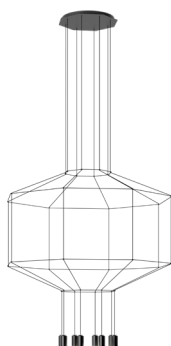

0300
120 x 120 cm

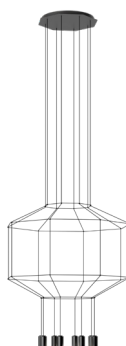

0301
89 x 89 cm

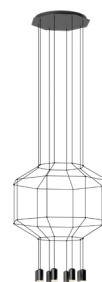

0302
70 x 70 cm

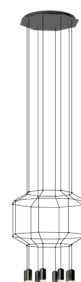

0303
55 x 55 cm

Personalise your own Wireflow composition quick and easy at vibia.com

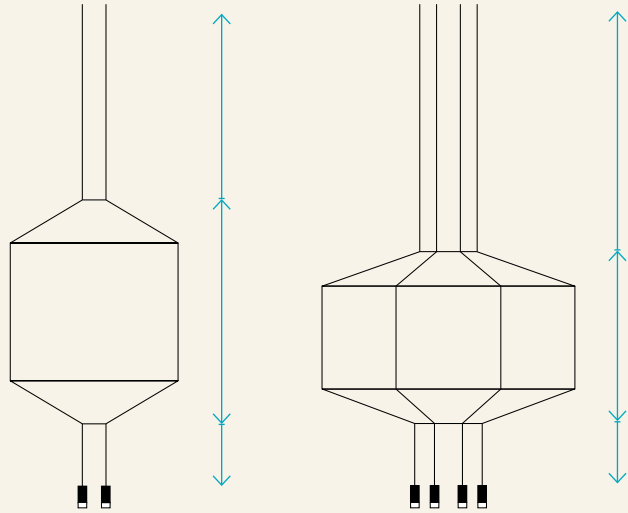

Pressed-glass diffuser.



0299

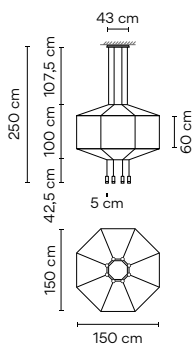

Finishes
 ● **04/** __ Black
 (RAL 9005)

LED Colour Temperature
 /1 _ 2700 K - 3880 lm
 D
 /2 _ 3000 K - 3880 lm
 /3 _ 3500 K - 4002,4 lm
 E
 CRI >90

Control
0299 __ / __
 __ / _ A Push; 1-10V; DALI-2
 __ / _ Z Casambi

Materials
 Diffuser: Pressed-glass.
 Horizontal rods and Canopy: Steel.
 Body: Aluminum.

Light Source and electronics
 8 x LED 4,5 W 350 mA
 Constant Current 350 mA
 110-240V 50/60Hz

Packaging
 2 Boxes
 Total Vol 0,3245 m³
 Gross weight 20,6 Kg Net weight 9,6 Kg

Notes
 Pressed-glass diffuser.
Configuration layout at vibia.com
 Min. quantity, upcharge and extra lead time apply.



0300

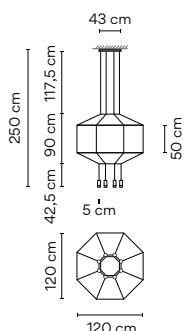

Finishes ● 04/ __ Black (RAL 9005)	LED Colour Temperature /1_ 2700 K - 3880 lm <input type="checkbox"/>	Control 0300 __ / __ __ / __ A Push; 1-10V; DALI-2 __ / __ Z Casambi
	/2_ 3000 K - 3880 lm /3_ 3500 K - 4002,4 lm <input type="checkbox"/>	
	CRI >90	
	Materials Diffuser: Pressed-glass. Horizontal rods and Canopy: Steel. Body: Aluminum.	

Light Source and electronics 8 x LED 4,5 W 350 mA Constant Current 350 mA 110-240V 50/60Hz	Packaging 2 Boxes Total Vol 0,3246 m ³ Gross weight 19,95 Kg Net weight 8,95 Kg
Notes Pressed-glass diffuser. Configuration layout at vibia.com Min. quantity, upcharge and extra lead time apply.	LED <input type="checkbox"/> IP20 <input type="checkbox"/> CE <input type="checkbox"/> UK <input type="checkbox"/> ENEC <input type="checkbox"/> <input type="checkbox"/> Bi-volt <input type="checkbox"/>

0301

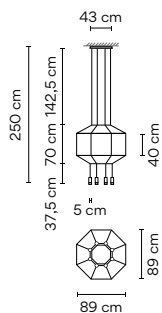

Finishes ● 04/ __ Black (RAL 9005)	LED Colour Temperature /1_ 2700 K - 3880 lm <input type="checkbox"/>	Control 0301 __ / __ __ / __ A Push; 1-10V; DALI-2 __ / __ Z Casambi
	/2_ 3000 K - 3880 lm /3_ 3500 K - 4002,4 lm <input type="checkbox"/>	
	CRI >90	
	Materials Diffuser: Pressed-glass. Horizontal rods and Canopy: Steel. Body: Aluminum.	

Light Source and electronics 8 x LED 4,5 W 350 mA Constant Current 350 mA 110-240V 50/60Hz	Packaging 2 Boxes Total Vol 0,2100 m ³ Gross weight 17,75 Kg Net weight 8,75 Kg
Notes Pressed-glass diffuser. Configuration layout at vibia.com Min. quantity, upcharge and extra lead time apply.	LED <input type="checkbox"/> IP20 <input type="checkbox"/> CE <input type="checkbox"/> UK <input type="checkbox"/> ENEC <input type="checkbox"/> <input type="checkbox"/> Bi-volt <input type="checkbox"/>

0302

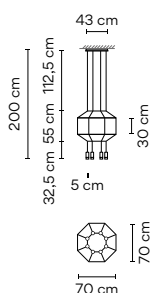

Finishes ● 04/ __ Black (RAL 9005)	LED Colour Temperature /1_ 2700 K - 3880 lm <input type="checkbox"/>	Control 0302 __ / __ __ / __ A Push; 1-10V; DALI-2 __ / __ Z Casambi
	/2_ 3000 K - 3880 lm /3_ 3500 K - 4002,4 lm <input type="checkbox"/>	
	CRI >90	
	Materials Diffuser: Pressed-glass. Horizontal rods and Canopy: Steel. Body: Aluminum.	

Light Source and electronics 8 x LED 4,5 W 350 mA Constant Current 350 mA 110-240V 50/60Hz	Packaging 2 Boxes Total Vol 0,1558 m ³ Gross weight 14,6 Kg Net weight 8,6 Kg
Notes Pressed-glass diffuser. Configuration layout at vibia.com Min. quantity, upcharge and extra lead time apply.	LED <input type="checkbox"/> IP20 <input type="checkbox"/> CE <input type="checkbox"/> UK <input type="checkbox"/> ENEC <input type="checkbox"/> <input type="checkbox"/> Bi-volt <input type="checkbox"/>

0303

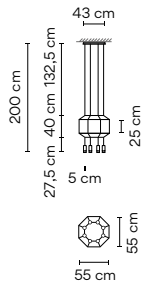

Finishes
04/ __ Black
 (RAL 9005)

LED Colour Temperature
 /1 _ 2700 K - 3880 lm
 D
 /2 _ 3000 K - 3880 lm
 /3 _ 3500 K - 4002,4 lm
 E
 CRI >90

Control
0303 __ / __

__ / __ A Push; 1-10V; DALI-2
 __ / __ Z Casambi

Materials
 Diffuser: Pressed-glass.
 Horizontal rods and Canopy: Steel.
 Body: Aluminum.

Light Source and electronics
 8 x LED 4,5 W 350 mA
 Constant Current 350 mA
 110-240V 50/60Hz

Packaging
 2 Boxes
 Total Vol 0,1558 m³
 Gross weight 13 Kg Net weight 8,5 Kg

Notes
 Pressed-glass diffuser.
Configuration layout at vibia.com
 Min. quantity, upcharge and extra lead time apply.



0309

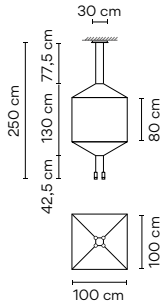

Finishes
04/ __ Black
 (RAL 9005)

LED Colour Temperature
 /1 _ 2700 K - 1940 lm
 D
 /2 _ 3000 K - 1940 lm
 /3 _ 3500 K - 2001,2 lm
 E
 CRI >90

Control
0309 __ / __

__ / __ A Push; 1-10V; DALI-2
 __ / __ Z Casambi

Materials
 Diffuser: Pressed-glass.
 Horizontal rods and Canopy: Steel.
 Body: Aluminum.

Light Source and electronics
 4 x LED 4,5 W 350 mA
 Constant Current 350 mA
 110-240V 50/60Hz

Packaging
 2 Boxes
 Total Vol 0,2100 m³
 Gross weight 12,3 Kg Net weight 5,3 Kg

Notes
 Pressed-glass diffuser.
Configuration layout at vibia.com
 Min. quantity, upcharge and extra lead time apply.



0310

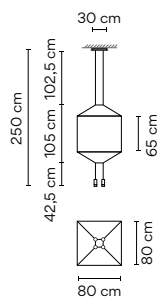

Finishes
04/ __ Black
 (RAL 9005)

LED Colour Temperature
 /1 _ 2700 K - 1940 lm
 D
 /2 _ 3000 K - 1940 lm
 /3 _ 3500 K - 2001,2 lm
 E
 CRI >90

Control
0310 __ / __

__ / __ A Push; 1-10V; DALI-2
 __ / __ Z Casambi

Materials
 Diffuser: Pressed-glass.
 Horizontal rods and Canopy: Steel.
 Body: Aluminum.

Light Source and electronics
 4 x LED 4,5 W 350 mA
 Constant Current 350 mA
 110-240V 50/60Hz

Packaging
 2 Boxes
 Total Vol 0,2100 m³
 Gross weight 11,8 Kg Net weight 4,8 Kg

Notes
 Pressed-glass diffuser.
Configuration layout at vibia.com
 Min. quantity, upcharge and extra lead time apply.

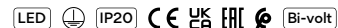

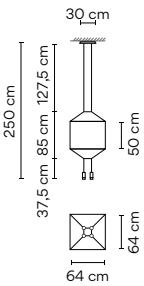
0311 	Finishes ● 04/ __ Black (RAL 9005)	LED Colour Temperature /1 _ 2700 K - 1940 lm <input type="checkbox"/> D /2 _ 3000 K - 1940 lm /3 _ 3500 K - 2001,2 lm <input type="checkbox"/> E CRI >90	Control 0311 __ / __ __ / __ A Push; 1-10V; DALI-2 __ / __ Z Casambi
	Materials Diffuser: Pressed-glass. Horizontal rods and Canopy: Steel. Body: Aluminum.	Packaging 2 Boxes Total Vol 0,1558 m ³ Gross weight 8,7 Kg Net weight 4,7 Kg	Notes Pressed-glass diffuser. Configuration layout at vibia.com Min. quantity, upcharge and extra lead time apply.

LED IP20 CE UK ENEC Bi-volt

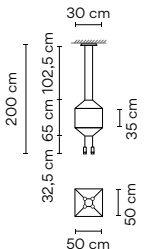
0312 	Finishes ● 04/ __ Black (RAL 9005)	LED Colour Temperature /1 _ 2700 K - 1940 lm <input type="checkbox"/> D /2 _ 3000 K - 1940 lm /3 _ 3500 K - 2001,2 lm <input type="checkbox"/> E CRI >90	Control 0312 __ / __ __ / __ A Push; 1-10V; DALI-2 __ / __ Z Casambi
	Materials Diffuser: Pressed-glass. Horizontal rods and Canopy: Steel. Body: Aluminum.	Packaging 2 Boxes Total Vol 0,1558 m ³ Gross weight 8,6 Kg Net weight 4,6 Kg	Notes Pressed-glass diffuser. Configuration layout at vibia.com Min. quantity, upcharge and extra lead time apply.

LED IP20 CE UK ENEC Bi-volt

