

Sticks

Design by Arik Levy

Fusing technology, space, and architecture, Sticks offers a creative toolkit for integrating light elements in an interior. Pure and graphic, the minimalist aluminum rods transform linear light into floating sculpture.



You can choose the desired composition through one of the following three options:

A - Choose among pre-designed layouts the one that fits with your project and order it directly (see page 466).

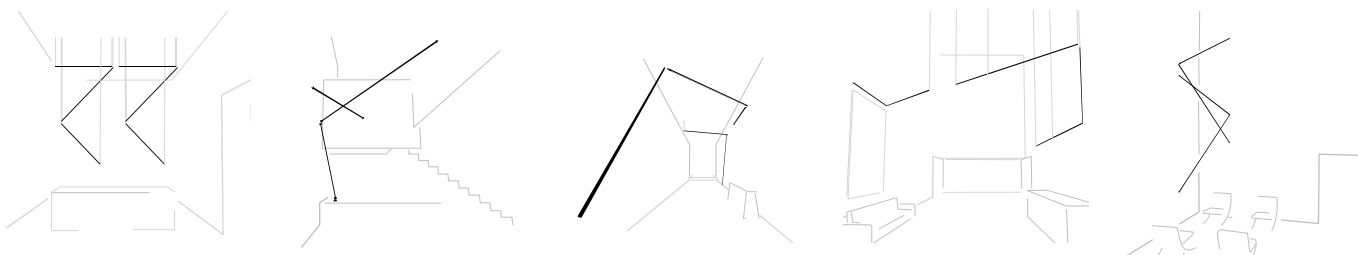

B - Select one composition on vibia.com among multiple applications in spaces, and adjust it to your project by modifying:

- + Length of the sticks.
- + Position of each stick in the space.
- + Colour temperature and dimming.
- + Installation type.

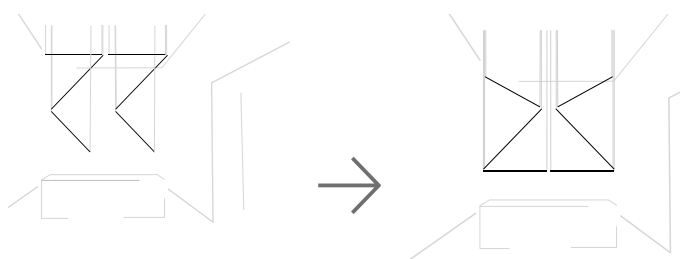

C - Create your configuration on vibia.com from scratch in three easy steps, without sketches.

1

Choose the location for your electrical connection point



2

Add connectable Sticks up to 6.5 meters



3

Configure
+ Colour temperature
+ Dimming control
+ Installation type
+ Pendant height



Technical Specifications

(see page 474)

The Sticks collection has three sizes: 1.5 m, 2 m, or 3 m, and they can be connected one to each other to a total maximum length of 6.5 meters per electrical connection.

Wall-Wall / Ceiling-Ceiling

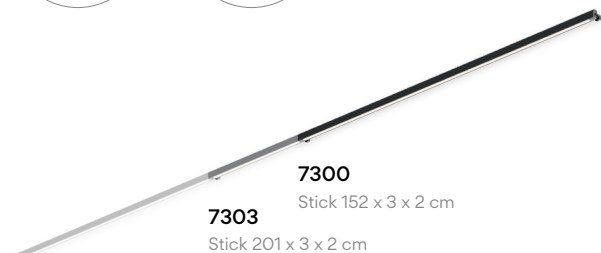
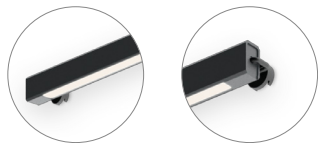

7306
Stick 300 x 3 x 2 cm

Wall-Wall (corner) / Wall-Ceiling

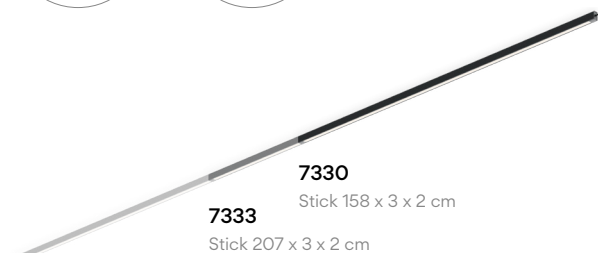
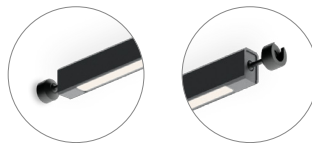

7336
Stick 306 x 3 x 2 cm

Wall-Pendant

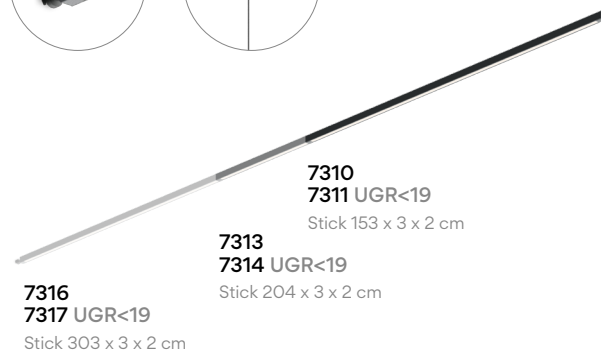
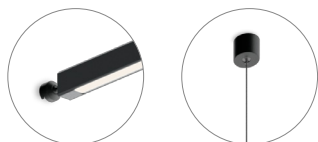

Pendant-Pendant

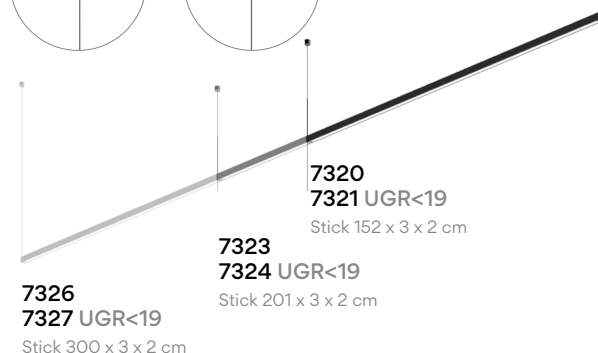
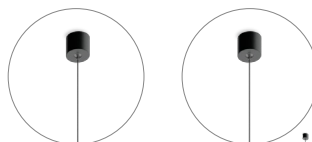

Pendant

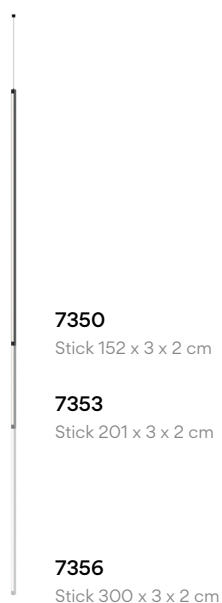

Floor-Wall

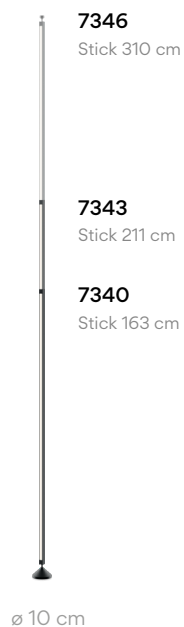
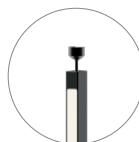

Sticks Connectable

Next sketches are composed by one or more compositions

Pendant / Ceiling

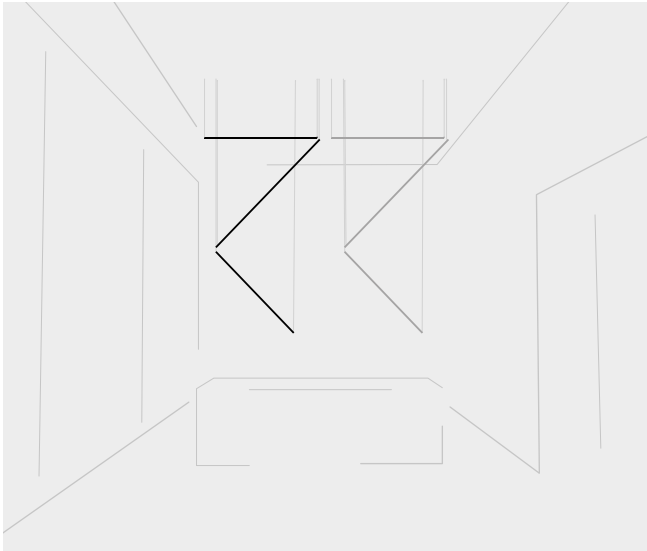

ST1001

Sketch composed by two identical compositions.

Each composition:

3 Sticks: 2 x 150 cm, 1 x 200 cm. Total 5 m.
LED 3500 K. 11870 lm. 88 W.
Remote driver Built-in Micro. 1-10V.

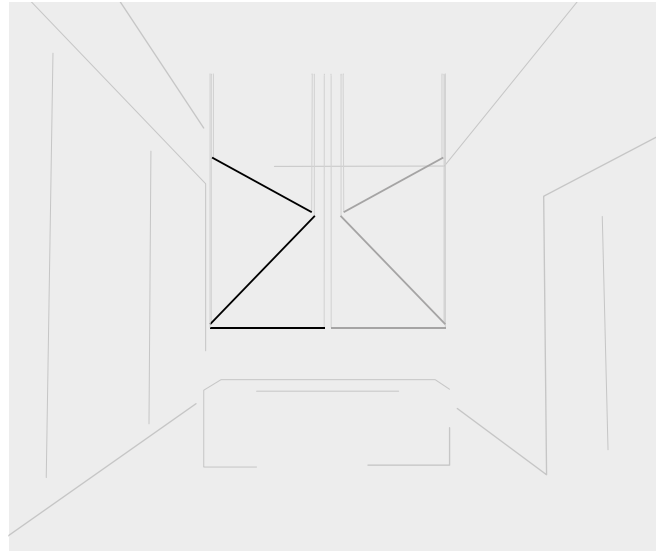

ST1005

Sketch composed by two identical compositions.

Each composition:

3 Sticks: 2 x 150 cm, 1 x 200 cm. Total 5 m.
LED 3500 K. 11870 lm. 88 W.
Remote driver Built-in Micro. 1-10V.

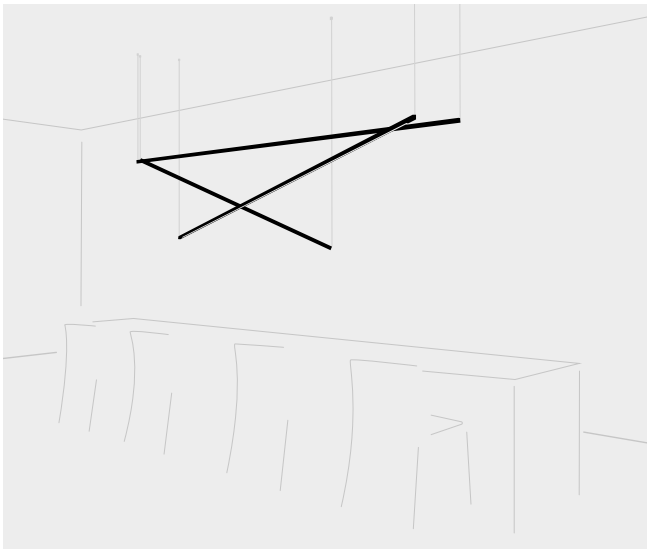

ST1015

Sketch composed by two compositions.

Composition 1:

2 Sticks: 1 x 150 cm, 1 x 300 cm. Total 4,5 m.
LED 2700 K. 9779 lm. 79,2 W.
Built-in disc S canopy. 1-10V.

Composition 2:

1 Stick: 1 x 300 cm. Total 3 m.
LED 2700 K. 6519 lm. 52,8 W.
Built-in disc S canopy. 1-10V.

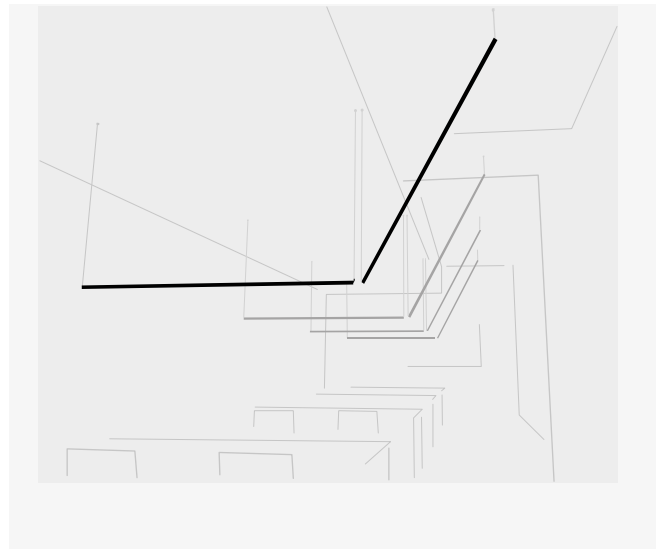

ST1021

Sketch composed by four identical compositions.

Each composition:

2 Sticks: 2 x 200 cm. Total 4 m.
LED 3500 K. 9496 lm. 140,8 W.
Built-in disc S canopy. 1-10V.

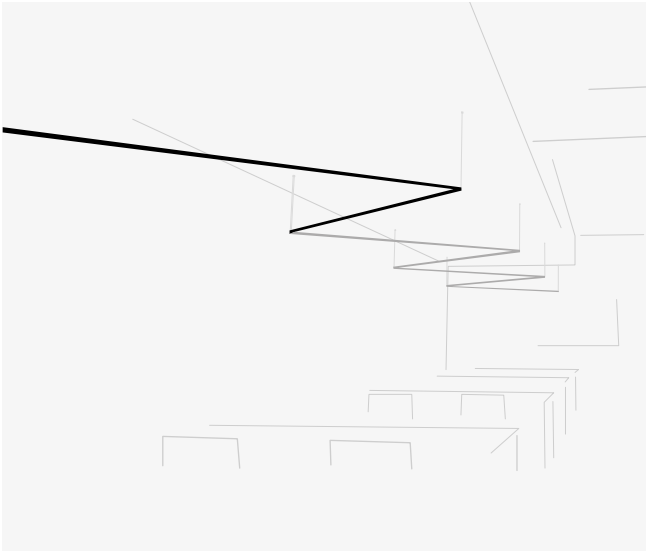

ST1025

Sketch composed by four identical compositions.

Each composition:

2 Sticks: 2 x 300 cm. Total 6 m.
LED 3500 K. 14244 lm. 105,6 W.
Built-in disc S canopy. 1-10V.

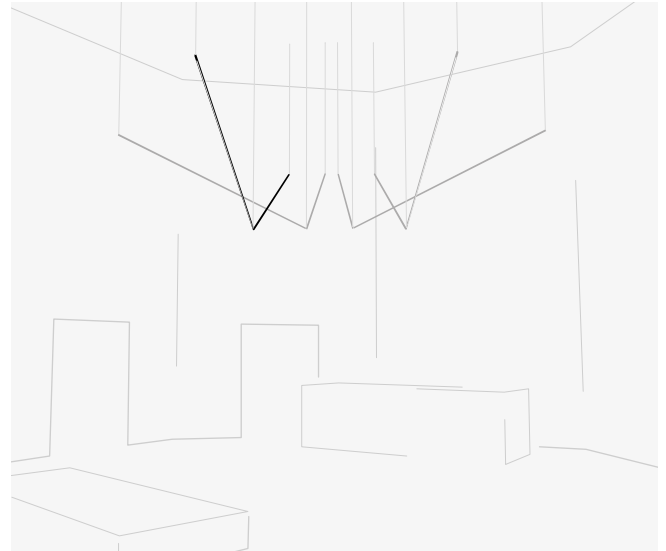

ST1035

Sketch composed by four identical compositions.

Each composition:

2 Sticks: 1 x 300 cm, 1 x 150 cm. Total 4,5 m.
LED 3500 K. 10683 lm. 79,2 W.
Built-in disc S canopy. 1-10V.

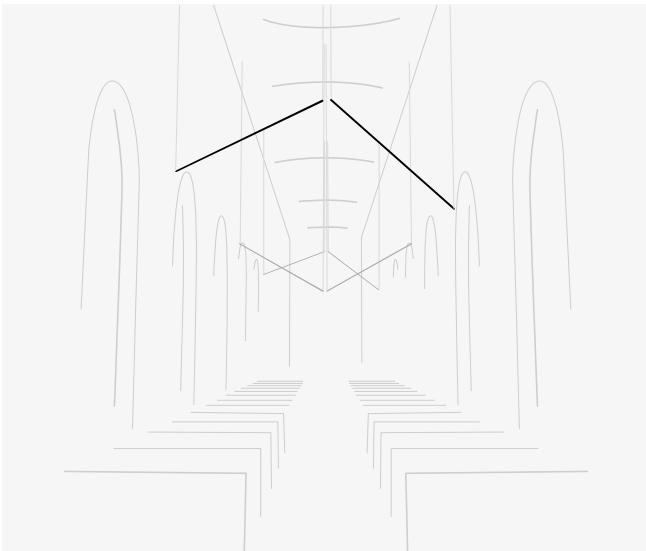

ST1041

Sketch composed by three identical compositions.

Each composition:

2 Sticks: 2 x 300 cm. Total 6 m.
LED 3500 K. 14244 lm. 105,6 W.
Built-in disc S canopy. 1-10V.

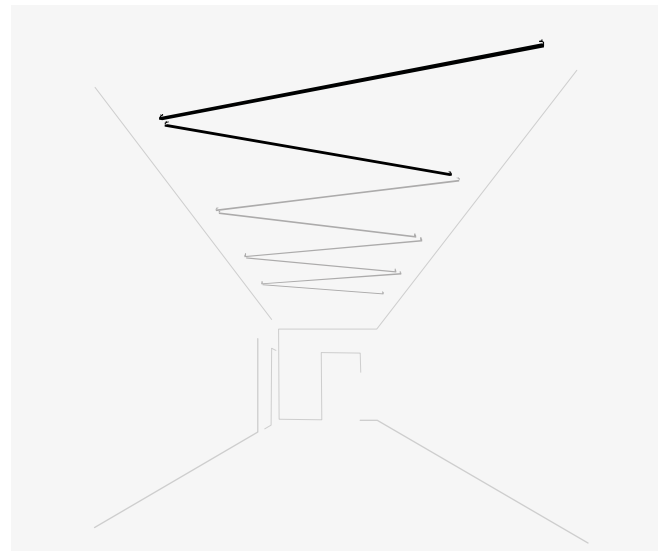

ST1085

Sketch composed by four identical compositions.

Each composition:

2 Sticks: 2 x 300 cm. Total 6 m.
LED 3500 K. 14244 lm. 105,6 W.
Remote driver Built-in Micro. 1-10V.

Sticks Connectable

Next sketches are composed by one or more compositions

Some sticks are attached to the Wall

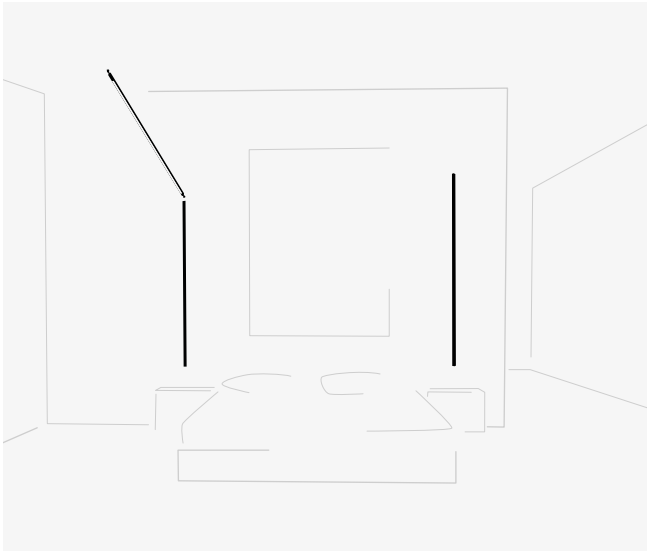

STI051
Sketch composed by two compositions.

Composition 1:
2 Sticks: 2 x 150 cm. Total 3 m.
LED 2700 K. 6520 lm. 52,8 W.
Floor base & plug. Push.

Composition 2:
1 Stick: 1 x 200 cm. Total 2 m.
LED 2700 K. 4346 lm. 35,2 W.
Floor base & plug. Push.

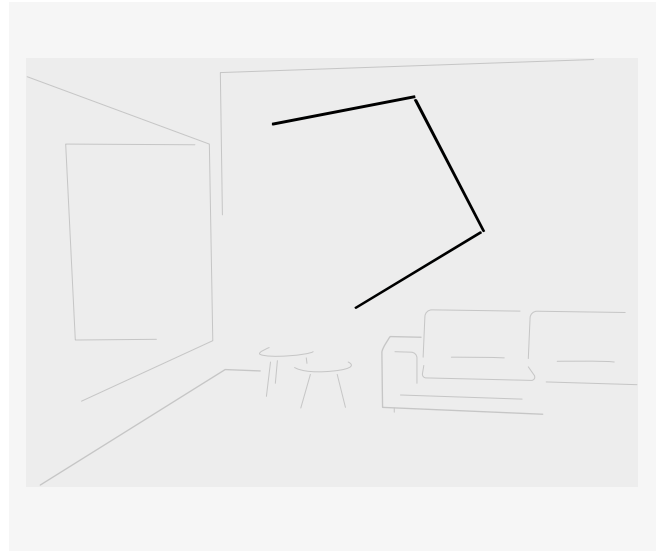

STI055
Sketch composed by only one composition.

3 Sticks: 3 x 150 cm. Total 4,5 m.
LED 2700 K. 9780 lm. 79,2 W.
Floor base & plug. Push.

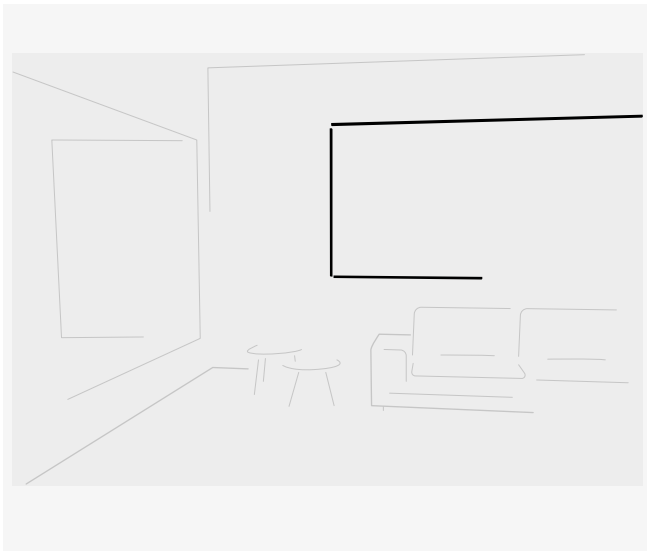

STI061
Sketch composed by only one composition.

3 Sticks: 2 x 150 cm, 1 x 300 cm. Total 6 m.
LED 2700 K. 13039 lm. 105,6 W.
Floor base & plug. Push.

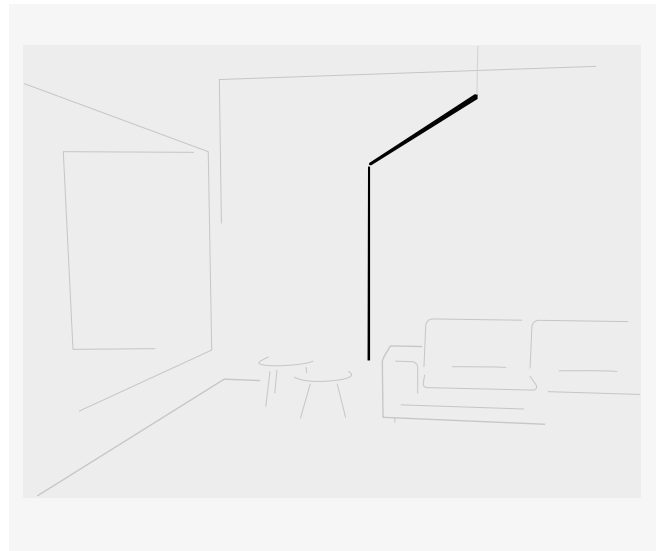

STI065
Sketch composed by only one composition.

2 Sticks: 2 x 150 cm. Total 3 m.
LED 2700 K. 6520 lm. 52,8 W.
Floor base & plug. Push.

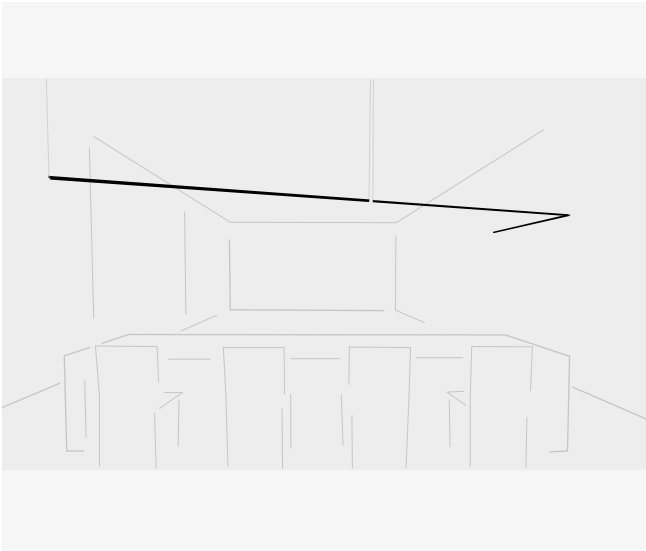

ST1071

Sketch composed by only one composition.

3 Sticks: 1 x 150 cm, 2 x 200 cm. Total 5,5 m.
 LED 2700 K. 11952 lm. 96,8 W.
 Floor base & plug. Push.

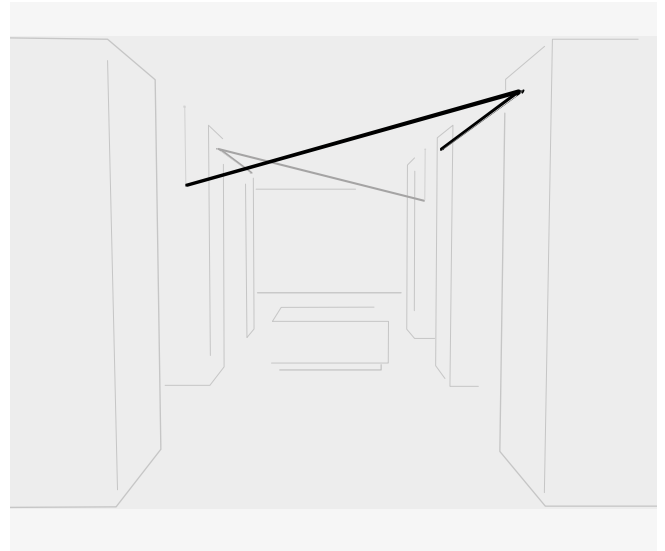

ST1075

Sketch composed by two identical compositions.

Each composition:
 2 Sticks: 2 x 300 cm. Total 6 m.
 LED 3500 K. 14244 lm. 105,6 W.
 Remote driver Built-in Micro. 1-10V.

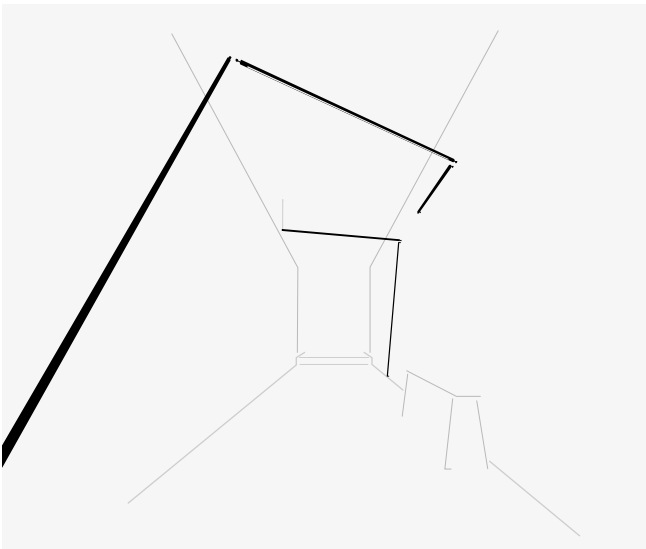

ST1081

Sketch composed by two compositions.

Composition 1:
 3 Sticks: 1 x 150 cm, 1 x 200 cm, 1 x 300 cm. Total 6,5 m.
 LED 3500 K. 15431 lm. 114,4 W.
 Remote driver Built-in Micro. 1-10V.

Composition 2:
 2 Sticks: 1 x 300 cm, 1 x 200 cm. Total 5 m.
 LED 3500 K. 11870 lm. 88 W.
 Remote driver Built-in Micro. 1-10V.

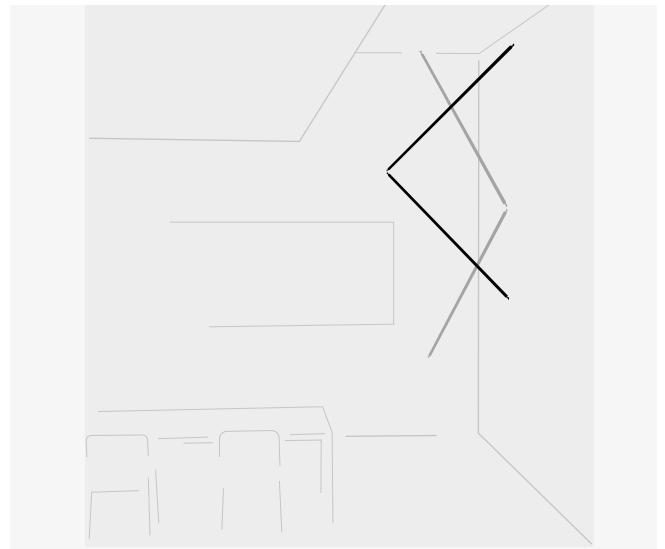

ST1091

Sketch composed by two identical compositions.

Each composition:
 2 Sticks: 2 x 200 cm. Total 4 m.
 LED 2700 K. 8692 lm. 70,4 W.
 Remote driver Built-in Micro. 1-10V.

Sticks Connectable

Next sketches are composed by one or more compositions

Some sticks are attached to the Wall



ST1095

Sketch composed by two identical compositions.

Each composition:

2 Sticks: 1 x 200 cm, 1 x 300 cm. Total 5 m.

LED 3500 K. 11870 lm. 88 W.

Remote driver Built-in Micro. 1-10V.

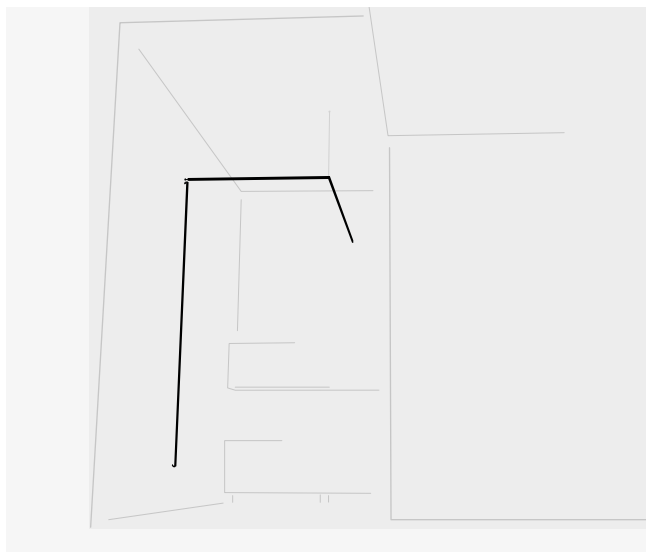

ST1101

Sketch composed by two compositions.

Composition 1:

2 Sticks: 1 x 300 cm, 1 x 150 cm. Total 4,5 m.

LED 2700 K. 9779 lm. 79,2 W.

Remote driver Built-in Micro. 1-10V.

Composition 2:

1 Stick: 1 x 300 cm. Total 3 m.

LED 2700 K. 6519 lm. 52,8 W.

Remote driver Built-in Micro. 1-10V.

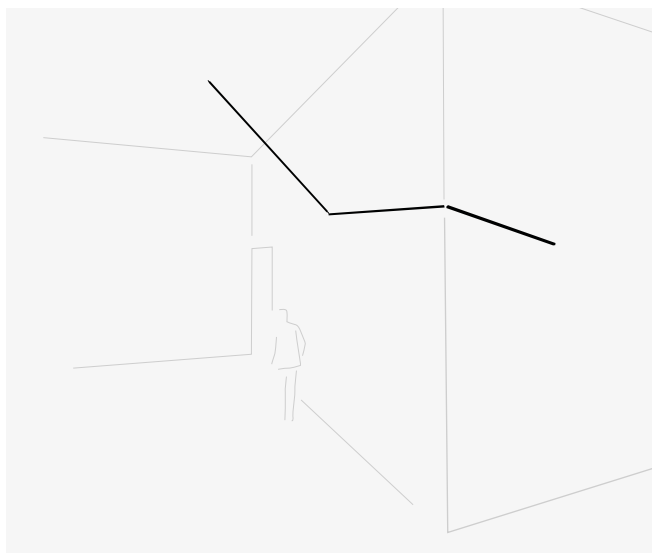

ST1105

Sketch composed by only one composition.

3 Sticks: 2 x 150 cm, 1 x 200 cm. Total 5 m.

LED 3500 K. 11870 lm. 88 W.

Floor base & plug. Push.

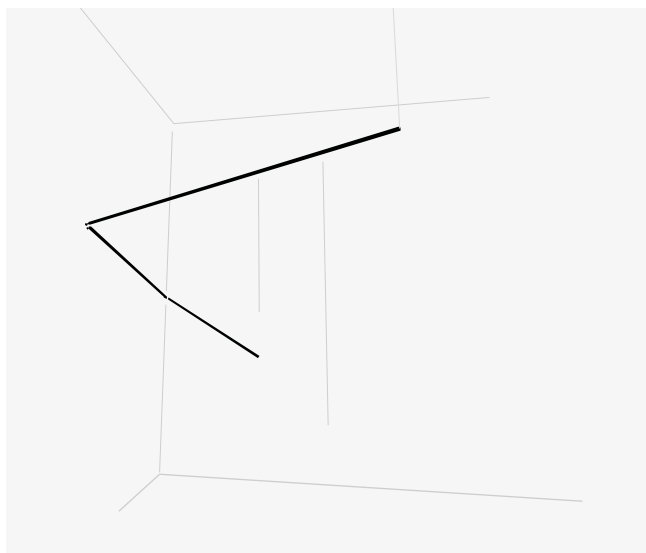

ST1111

Sketch composed by only one composition.

3 Sticks: 2 x 150 cm, 1 x 300 cm. Total 6 m.

LED 3500 K. 14244 lm. 105,6 W.

Remote driver Built-in Micro. 1-10V.

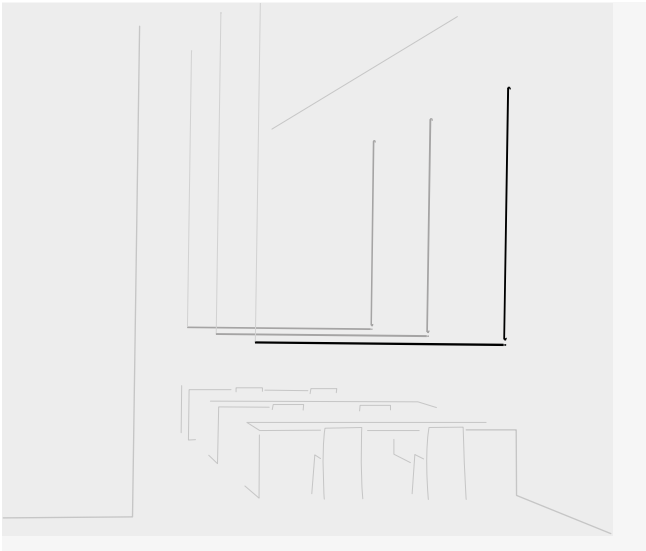

ST115

Sketch composed by three identical compositions.

Each composition:

2 Sticks: 2 x 200 cm. Total 4 m.
 LED 3500 K. 9496 lm. 70,4 W.
 Built-in disc S canopy. 1-10V.

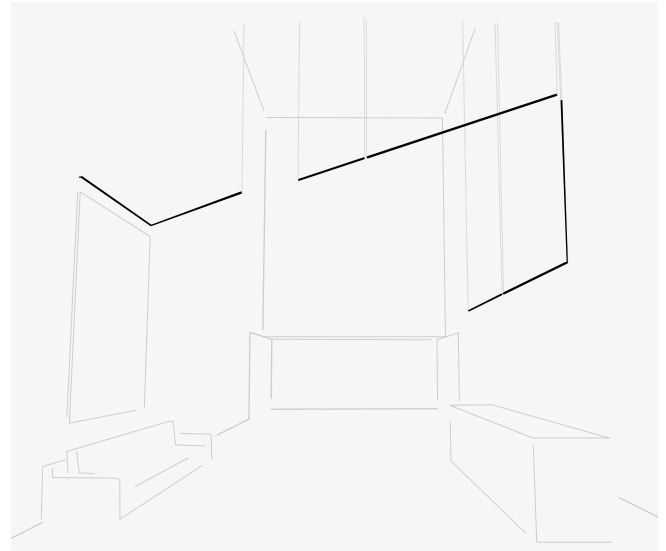

ST131

Sketch composed by four compositions.

Composition 1:

2 Sticks: 2 x 300 cm. Total 6 m.
 LED 3500 K. 14244 lm. 105,6 W.
 Remote driver Built-in Micro. 1-10V.

Composition 2:

1 Stick: 1 x 150 cm. Total 1,5 m.
 LED 3500 K. 3561 lm. 26,4 W.
 Remote driver Built-in Micro. 1-10V.

Composition 3:

2 Sticks: 2 x 300 cm. Total 6 m.
 LED 3500 K. 14244 lm. 105,6 W.
 Remote driver Built-in Micro. 1-10V.

Composition 4:

2 Sticks: 2 x 300 cm. Total 6 m.
 LED 3500 K. 14244 lm. 105,6 W.
 Remote driver Built-in Micro. 1-10V.

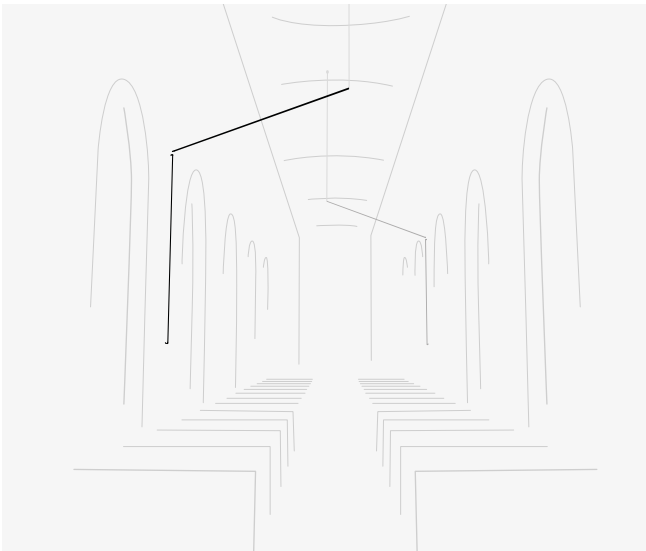

ST141

Sketch composed by two identical compositions.

Each composition:

2 Sticks: 2 x 300 cm. Total 6 m.
 LED 3500 K. 14244 lm. 105,6 W.
 Built-in disc S canopy. 1-10V.

Sticks Connectable

Next sketches are composed by one or more compositions

Some sticks are on the Floor

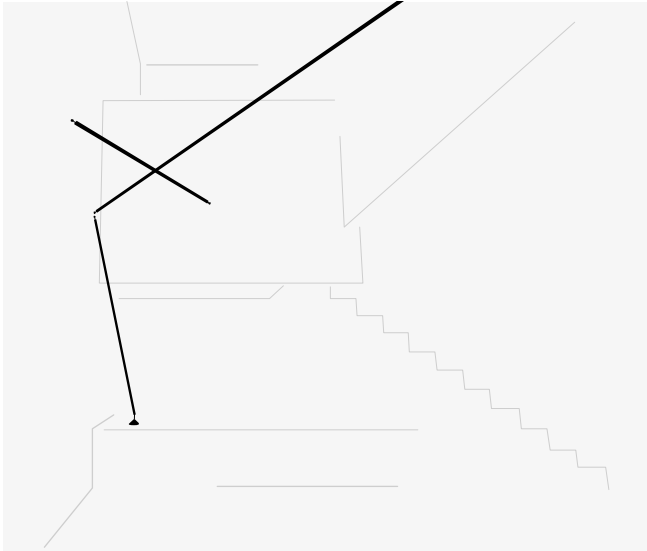

ST1151

Sketch composed by two compositions.

Composition 1:

1 Stick: 1 x 150 cm. Total 1,5 m.
LED 2700 K. 3260 lm. 26,4 W.
Remote driver Built-in Micro. 1-10V.

Composition 2:

2 Sticks: 1 x 200 cm, 1 x 300 cm. Total 5 m.
LED 2700 K. 10865 lm. 88 W.
Remote driver Built-in Micro. 1-10V.

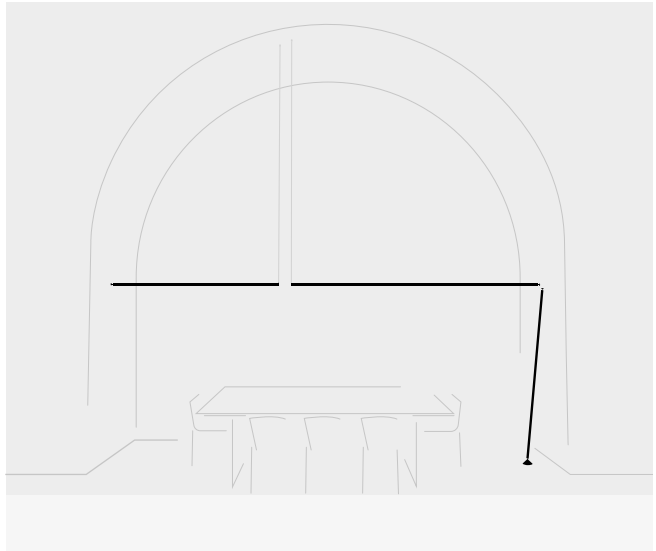

ST1161

Sketch composed by two compositions.

Composition 1:

1 Stick: 1 x 200 cm. Total 2 m.
LED 2700 K. 4336 lm. 35,2 W.
Remote driver Built-in Micro. 1-10V.

Composition 2:

2 Sticks: 1 x 300 cm, 1 x 200 cm. Total 5 m.
LED 2700 K. 10865 lm. 88 W.
Remote driver Built-in Micro. 1-10V.



ST1171

Sketch composed by two compositions.

Composition 1:

3 Sticks: 3 x 200 cm. Total 6 m.
LED 3500 K. 14244 lm. 105,6 W.
Surface canopy. 1-10V.

Composition 2:

2 Sticks: 1 x 200 cm, 1 x 300 cm. Total 5 m.
LED 3500 K. 11870 lm. 88 W.
Surface canopy. 1-10V.

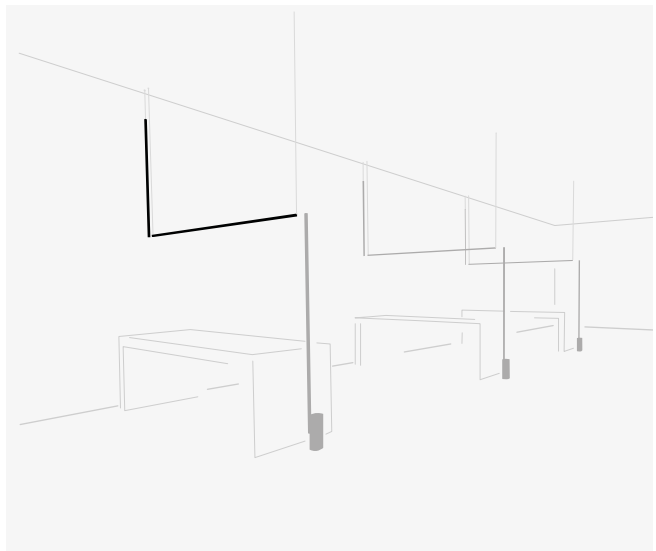

ST1175

Sketch composed by three identical compositions.

Each composition:

2 Sticks: 1 x 150 cm, 1 x 200 cm. Total 3,5 m.
LED 3500 K. 8309 lm. 61,6 W.
Surface canopy. 1-10V.

Some sticks are attached to the Wall

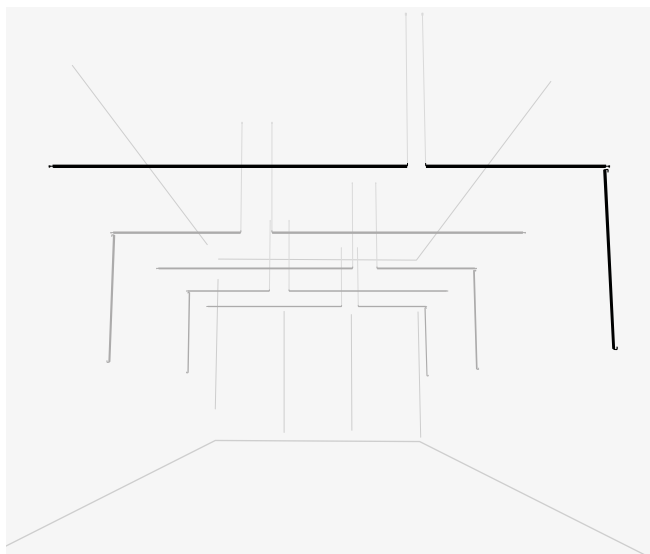

ST1145

Sketch composed by five identical compositions.

Each composition:

3 Sticks: 1 x 300 cm, 2 x 150 cm . Total 6 m.

LED 3500 K. 14244 lm. 105,6 W.

Remote driver Built-in Micro. 1-10V

Each project is unique.
Visit vibia.com and chose among
multiple compositions designed
and adapted to your project needs.

Personalize your own Sticks composition
quick and easy at vibia.com.

Sticks Connectable



Elements to be configured

Wall-Wall / Ceiling-Ceiling
Wall-Wall (corner) / Wall-Ceiling
Wall-Pendant
Pendant-Pendant
Pendant-Ceiling
Pendant

Sticks 1,5 m.

7300 7310 7311 7320 7321 7330 7350

Temperature Colour

- /1 _ 2700 K  CRI >90 3260 lm 123 lm/W
/2 _ 3000 K  CRI >90 3510 lm 133 lm/W
/3 _ 3500 K  CRI >90 3480 lm 132 lm/W



1 x LED STRIP 26,4 W 24V

Net weight 0,9 Kg.

Sticks 2 m.

7303 7313 7314 7323 7324 7333 7353

Temperature Colour

- /1 _ 2700 K  CRI >90 4346 lm 123 lm/W
/2 _ 3000 K  CRI >90 4680 lm 133 lm/W
/3 _ 3500 K  CRI >90 4640 lm 132 lm/W



1 x LED STRIP 35,2 W 24V

Net weight 1,2 Kg.

Sticks 3 m.

7306 7316 7317 7326 7327 7336 7356

Temperature Colour

- /1 _ 2700 K  CRI >90 6519 lm 123 lm/W
/2 _ 3000 K  CRI >90 7020 lm 133 lm/W
/3 _ 3500 K  CRI >90 6960 lm 132 lm/W

1 x LED STRIP 52,8 W 24V

Net weight 1,8 Kg.

Sticks: Aluminum.

Diffuser: PC- Polycarbonate.

Driver and Dimming depends on selected installation accessory (see page 475).

Suspension cables up to 3m. for Wall - Pendant and Pendant-Pendant.







Personalisation options available

- Extra cable length for Wall - Pendant and Pendant - Pendant.

Min. quantity, upcharge and extra lead time apply.

11 Black

(NCS S 8500-N)





Horizontal pendant version with a UGR index <19 available.

Floor-Wall

Sticks 1,5 m.

7340

Temperature Colour

- /1 _ 2700 K  CRI >90 3260 lm 123 lm/W
/2 _ 3000 K  CRI >90 2644 lm 100,15 lm/W
/3 _ 3500 K  CRI >90 3480 lm 132 lm/W



1 x LED STRIP 26,4 W 24V

Net weight 1,5 Kg.

Sticks 2 m.

7343

Temperature Colour

- /1 _ 2700 K  CRI >90 4346 lm 123 lm/W
/2 _ 3000 K  CRI >90 2644 lm 100,15 lm/W
/3 _ 3500 K  CRI >90 4640 lm 132 lm/W



1 x LED STRIP 35,2 W 24V

Net weight 1,8 Kg.

Sticks 3 m.

7346

Temperature Colour

- /1 _ 2700 K  CRI >90 6519 lm 123 lm/W
/2 _ 3000 K  CRI >90 5288 lm 100,15 lm/W
/3 _ 3500 K  CRI >90 6960 lm 132 lm/W

1 x LED STRIP 52,8 W 24V

Net weight 2,4 Kg.





Sticks: Aluminum.

Diffuser: PC- Polycarbonate.

Driver and Dimming depends on selected installation accessory (see page 475).

11 Black

(NCS S 8500-N)

Electrical connection options



Floor base & plug



Surface canopy



Built-in disc S



Remote driver Built-in Micro

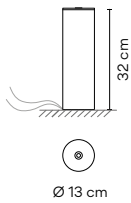

Floor base & plug
ACST000001 ACST000002
Driver Constant Voltage 24V.
90~305V. 50/60Hz.
Dimming: Push.

Materials
Body: Steel.
Packaging
1 Box.
0,16 x 0,16 x 0,4 m.
Vol. 0,01 m³.
Gross weight 8,5 Kg.
Net weight 7 Kg.

11 Black
(NCS S 8500-N)

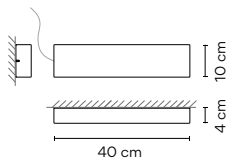

Surface canopy
ACST000003 ACST000004
Driver Constant Voltage 24V.
90~305V. 50/60Hz.
Dimming: 1-10V.
Personalisation options available
- Dimming: DALI-2, Casambi.
Min. quantity, upcharge and extra lead time apply.
To be installed on ceiling or wall.

Materials
Body: Steel.
Packaging
1 Box.
0,50 x 0,25 x 0,25 m.
Vol. 0,03 m³.
Gross weight 2,9 Kg.
Net weight 2,5 Kg.

11 Black
(NCS S 8500-N)

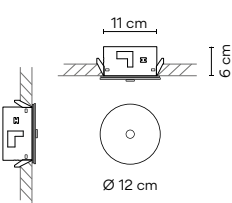

Built-in disc S
ACST000005 ACST000006
Driver Constant Voltage 24V.
90~305V. 50/60Hz.
Dimming: 1-10V.
Personalisation options available
- Dimming: DALI-2, Casambi.
Min. quantity, upcharge and extra lead time apply.
To be installed on ceiling or wall.

Materials
Body: Steel.
Packaging
1 Box.
0,25 x 0,25 x 0,25 m.
Vol. 0,01 m³.
Gross weight 1,8 Kg.
Net weight 1,5 Kg.

11 Black
(NCS S 8500-N)

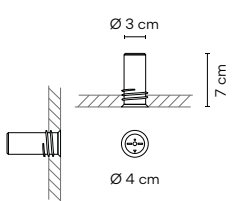

Remote driver Built-in Micro
ACST000007 ACST000008
Driver Constant Voltage 24V.
90~305V. 50/60Hz.
Dimming: 1-10V.
Personalisation options available
- Dimming: DALI-2, Casambi.
Min. quantity, upcharge and extra lead time apply.
To be installed on ceiling or wall.

Materials
Body: Aluminum.
Packaging
1 Box.
0,25 x 0,25 x 0,25 m.
Vol. 0,01 m³.
Gross weight 1,8 Kg.
Net weight 1,5 Kg.

11 Black
(NCS S 8500-N)

