

### CONTENITORE ORIZZONTALE DINING HIGH/LOW

#### Finiture struttura portante a "L":

- in MDF, spessore mm 32, impiallacciato palissandro Santos\* tinto Dark Brown, laccato poliestere opaco;  
- in MDF, spessore mm 32, impiallacciato frassino rigato laccato a poro aperto Nero.

#### Finitura interna ed esterna dell'elemento contenitore:

- in MDF, spessore mm 16, impiallacciato palissandro Santos\* tinto Dark Brown, laccato poliestere opaco;  
- in MDF, spessore mm 22, impiallacciato frassino rigato laccato a poro aperto Nero;  
- in MDF, spessore mm 22, laccato lucido color Moka.  
Cassettoni (n. 2) e cassetti (n. 2) che scorrono su guide a estrazione totale con chiusura Blumotion.  
Maniglie in alluminio verniciato lucido color Brandy.  
Vassoio porta posate in cuoio Nero posizionato nel cassetto superiore.  
**Base:** piedini in tondino di alluminio, Ø mm 25, verniciato lucido color Brandy e telaio composto da barre di alluminio verniciato nero opaco.  
Scivolante protettivo in polietilene di colore nero.

### CONTENITORE ORIZZONTALE LIVING/TV

#### Finiture struttura portante a "L":

- in MDF, spessore mm 32, impiallacciato palissandro Santos\* tinto Dark Brown, laccato poliestere opaco e doghe in massello di noce Canaletto, sezione mm 31x21, tinto Dark Brown, laccato poliestere opaco;  
- in MDF, spessore mm 32, impiallacciato frassino rigato laccato a poro aperto Nero e doghe in massello di frassino, sezione mm 31x21, laccato a poro aperto Nero.

#### Finitura interna ed esterna dell'elemento contenitore:

- in MDF, spessore mm 16, impiallacciato palissandro Santos\* tinto Dark Brown, laccato poliestere opaco;  
- in MDF, spessore mm 16, impiallacciato frassino rigato laccato a poro aperto Nero;  
- in MDF, spessore mm 16, laccato lucido color Moka.  
Cassetti (n. 2) che scorrono su guide a estrazione totale con chiusura Blumotion.  
Maniglie in alluminio verniciato lucido color Brandy.  
**Base:** piedini in tondino di alluminio, Ø mm 25, verniciato lucido color Brandy e telaio composto da barre di alluminio verniciato nero opaco.  
Scivolante protettivo in polietilene di colore nero.

### DINING HIGH/LOW HORIZONTAL SIDEBOARD

#### "L" shape support structure

**finishes:**  
- in MDF, 32 mm thick, with palisander Santos\* veneer, stained Dark Brown with polyester matt lacquer finish;  
- in MDF, 32 mm thick, with streaked ash veneer, open pore Black lacquer finish.

#### Storage element - Interior and exterior finish:

- in MDF, 16 mm thick, with palisander Santos\* veneer, stained Dark Brown with polyester matt lacquer finish;  
- in MDF, 22 mm thick, with streaked ash veneer, open pore Black lacquer finish.  
- in MDF, 22 mm thick, Moka colour glossy lacquer finish.  
Large drawers (n. 2) and drawers (n. 2) that glide on full-extension runners with Blumotion closure.  
Aluminium handles with varnished polished Brandy colour finish.  
Black saddle-hide cutlery tray is located in the upper drawer.  
**Base:** feet in tubular aluminium, 25mm Ø, with varnished polished Brandy colour finish and frame made of aluminium rods varnished matt black.  
Black protective polyethylene glides.

### LIVING/TV HORIZONTAL SIDEBOARD

#### "L" shape support structure

**finishes:**  
- in MDF, 32 mm thick, with palisander Santos\* veneer, stained Dark Brown with polyester matt lacquer finish, and 31x21mm solid Canaletto walnut slats, stained Dark Brown with polyester matt lacquer finish;  
- in MDF, 32 mm thick, with streaked ash veneer, open-pore Black lacquer finish, and 31x21mm solid ash slats with open-pore Black lacquer finish.

#### Storage element - Interior and exterior finish:

- in MDF, 16 mm thick, with palisander Santos\* veneer, stained Dark Brown with polyester matt lacquer finish;  
- in MDF, 16 mm thick, with streaked ash veneer, open pore Black lacquer finish.  
- in MDF, 16 mm thick, Moka colour glossy lacquer finish.  
Drawers glide on full-extension runners with Blumotion closure.  
Aluminium handles with varnished polished Brandy colour finish.  
**Base:** feet in tubular aluminium, 25 mm Ø, with varnished polished Brandy colour finish and frame made of aluminium rods varnished matt black.  
Black protective polyethylene glides.

### HORIZONTALES SIDEBOARD DINING HIGH/LOW

#### "L-förmige" tragende Struktur:

- aus MDF, Stärke 32 mm, furniert mit Palisander Santos\* Dark Brown gebeizt, mit matter Polyesterlackierung;  
- aus MDF, Stärke 32 mm, furniert mit gestreiftem Eschenholz mit offenerporiger Lackierung in der Farbe Schwarz;

#### Innen und außen Ausführung des Kontainer-Elements:

- aus MDF, Stärke 16 mm, furniert mit Palisander Santos\* in Dark Brown gebeizt, mit matter Polyesterlackierung;  
- aus MDF, Stärke 22 mm, furniert mit gestreiftem Eschenholz mit offenerporiger Lackierung in der Farbe Schwarz;  
- aus MDF, Stärke 22 mm, glänzende Lackierung in der Farbe Mokka.  
Die großen Schubladen (2 Stk.) und Schubladen (2 Stk.) laufen auf Führungen mit Vollauszug und Blumotion-Verschluss.  
Griffe aus Aluminium mit glänzender Lackierung in der Farbe Brandy.  
Besteckablage aus schwarzem Kernleder in der oberen Schublade.  
**Basis:** Aluminiumstangen mit Ø 25 mm und glänzender Lackierung in der Farbe Brandy verbunden mit einem Rahmen aus mattschwarz lackierten Aluminiumstäben.  
Schutzgleiter aus Polyethylen in Schwarz.

### HORIZONTALES SIDEBOARD LIVING/TV

#### "L-förmige" tragende Struktur:

- aus MDF, Stärke 32 mm, furniert mit Palisander Santos\* Dark Brown gebeizt, mit matter Polyesterlackierung und Latten aus Canaletto Nussbaum, Profil 31 x 21 mm, Dark Brown gebeizt, mit matter Polyesterlackierung;  
- aus MDF, Stärke 32 mm, furniert mit gestreiftem Eschenholz mit offenerporiger Lackierung in der Farbe Schwarz und Latten aus massivem Eschenholz Profil 31 x 21 mm, mit offenerporiger Lackierung in der Farbe Schwarz.

#### Innen und außen Ausführung des Kontainer-Elements:

- aus MDF, Stärke 16 mm, furniert mit Palisander Santos\* Dark Brown gebeizt, mit matter Polyesterlackierung;  
- aus MDF, Stärke 16 mm, furniert mit gestreiftem Eschenholz mit offenerporiger Lackierung in der Farbe Schwarz;  
- aus MDF, Stärke 16 mm, glänzende Lackierung in der Farbe Mokka.  
Die Schubladen laufen auf Führungen mit Vollauszug und Blumotion-Verschluss.  
Griffe aus Aluminium mit glänzender Lackierung in der Farbe Brandy.  
**Basis:** Füße mit Aluminiumstangen mit Ø 25 mm und glänzender Lackierung in der Farbe Brandy verbunden mit einem Rahmen aus mattschwarz lackierten Aluminiumstäben.  
Schutzgleiter aus Polyethylen in Schwarz.

### BAHUT HORIZONTAL DINING HIGH/ LOW

#### Finitions structure portante en "L":

- en MDF, épaisseur 32 mm, plaqué palissandre de Santos\* teinté Dark Brown, laqué polyester mat ;  
- en MDF, épaisseur 32 mm, plaqué frêne strié laqué Noir à pores ouverts.

#### Finition interne et externe des tiroir-compartiments :

- en MDF, épaisseur 16 mm, plaqué palissandre de Santos\* teinté Dark Brown, laqué polyester mat ;  
- en MDF, épaisseur 22 mm, plaqué frêne strié laqué Noir à pores ouverts ;  
- en MDF, épaisseur 22 mm, laqué brillant couleur Moka.

Les 2 grands tiroirs et les 2 tiroirs coulissent sur des glissières à extension complète avec fermeture Blumotion.

Poignées en aluminium peint brillant couleur Brandy.

Plateau range-couverts en cuir de sellerie noir situé dans le tiroir supérieur.

**Base :** pieds en tige d'aluminium, Ø 25 mm, peint brillant couleur Brandy et châssis composé de barres en aluminium peint en noir mat.  
Patins glisseurs en polyéthylène noir.

### BAHUT HORIZONTAL LIVING/TV

#### Finitions structure portante en "L":

- en MDF, épaisseur 32 mm, plaqué palissandre de Santos\* teinté Dark Brown, laqué polyester mat et lattes en noyer Canaletto massif, section 31x21 mm, teinté Dark Brown, laqué polyester mat ;  
- en MDF, épaisseur 32 mm, plaqué frêne strié laqué Noir à pores ouverts et lattes en frêne massif, section 31x21 mm, laqué noir à pores ouverts.

#### Finition interne et externe des tiroir-compartiments :

- en MDF, épaisseur 16 mm, plaqué palissandre de Santos\* teinté Dark Brown, laqué polyester mat ;  
- en MDF, épaisseur 16 mm, plaqué frêne strié laqué Noir à pores ouverts ;  
- en MDF, épaisseur 16 mm, laqué brillant couleur Moka.

Les tiroirs coulissent sur des glissières à extension complète avec fermeture Blumotion.

Poignées en aluminium peint brillant couleur Brandy.

**Base :** pieds en tige d'aluminium, Ø 25 mm, peint brillant couleur Brandy et châssis composé de barres en aluminium peint en noir mat.  
Patins glisseurs en polyéthylène noir.

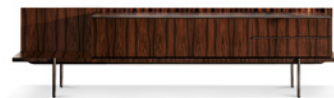

## CONTENITORE VERTICALE

### Finitura struttura:

- in stratificato di MDF e alluminio, spessore mm 16, impiallacciato palissandro Santos\* tinto Dark Brown, laccato poliestere opaco.

Telaio ante in alluminio verniciato lucido color Brandy, ante in vetro stratificato mm 3+3 bronzo con rete metallica interna color rame.

Ripiani interni (n. 2) in alluminio satinato, verniciato lucido color Brandy.

Cassettiera in MDF impiallacciato palissandro Santos\* tinto Dark brown, laccato poliestere opaco con maniglia ricavata in massello e fondo della maniglia in metallo verniciato color Brandy lucido.

Schienale interno in specchio bronzato, spessore mm 5.

All'interno del contenitore, sono presenti lungo i fianchi, n. 2 barre luminose a led con accensione tramite interruttore (alimentazione tramite batterie ricaricabili).

**Base:** piedini in tondino di alluminio, Ø mm 25, verniciato lucido color Brandy e telaio composto da barre di alluminio verniciato nero opaco. Scivolante protettivo in polietilene di colore nero.

**N.B.:** col passare del tempo, a causa delle escursioni termiche e delle variazioni di umidità, l'allineamento e lo spazio tra le varie doghe potrebbero subire qualche lieve cambiamento.

**\* il palissandro Santos deriva da foreste correttamente gestite.**

## VERTICAL CABINET

### Structure finishe:

- in laminated MDF and aluminium, 16 mm thick, with palisander Santos\* veneer, stained Dark Brown with polyester matt lacquer finish; Door frames in aluminium with varnished polished Brandy colour finish, doors in 3+3 mm bronzed colour laminated glass with internal copper colour metal mesh.

Internal shelves (n. 2) in satin-finish aluminium with varnished polished Brandy colour finish.

Drawers in MDF with palisander Santos\* veneer, stained Dark Brown with polyester matt lacquer finish, with solid wood handle and metal handle plate with varnished polished Brandy colour finish.

Back interior in bronzed mirror, 5 mm thick.

Inside the cabinet, along the sides are n. 2 LED strip lights with on/off switch (rechargeable batteries).

**Base:** feet in tubular aluminium, 25 mm Ø, with varnished polished Brandy colour finish and frame made of aluminium rods varnished matt black.

Black protective polyethylene glides.

**N.B.:** over time, due to variations in temperatures and humidity, the alignment of and space between the slats could change slightly.

**\* palisander Santos comes from properly managed forests.**

## VERTIKALES SIDEBOARD

### Ausführung der Struktur:

- aus MDF-Schichtholz und Aluminium, Stärke 16 mm, furniert mit Palisander Santos\* in Dark Brown gebeizt, mit matter Polyesterlackierung. Türrahmen aus glänzend lackiertem Aluminium in der Farbe Brandy, Türen aus Schichtglas 3+3 mm in der Farbe Bronze mit kupferfarbenem Metallnetz innen. Ablagen innen (2 Stk.) aus satiniertem Aluminium, glänzend lackiert in der Farbe Brandy.

Kommode aus MDF furniert mit Palisander Santos\* Dark Brown gebeizt, mit matter Polyesterlackierung mit Muschelgriff aus Massivholz und Griffboden aus glänzend lackiertem Metall in der Farbe Brandy.

Bronzierte Spiegelrückseite innen, Stärke 5 mm.

Im Inneren des Schrankes befinden sich entlang der Seiten 2 LED-Lichtleisten mit Einschalten per Schalter (Stromversorgung mit aufladbarem Akku).

**Basis:** Füße mit Aluminiumstangen mit Ø 25 mm und glänzender Lackierung in der Farbe Brandy verbunden mit einem Rahmen aus mattschwarz lackierten Aluminiumstäben. Schutzgleiter aus Polyethylen in Schwarz.

**N.B.:** Im Laufe der Zeit können sich aufgrund von Temperatur- und Feuchtigkeitsschwankungen die Ausrichtung und die Abstände zwischen den verschiedenen Latten leicht verändern.

**\* Santos Palisander stammt aus korrekt bewirtschafteten Wäldern.**

## BAHUT VERTICAL

### Finition de la structure :

- en MDF stratifié et aluminium, épaisseur 16 mm, plaqué palissandre de Santos\* teinté Dark Brown, laqué polyester mat.

Cadre des portes en aluminium peint brillant couleur Brandy, portes en verre feuilleté 3 + 3 mm bronze avec treillis métallique interne couleur cuivre.

2 étagères internes en aluminium satiné, peint brillant couleur Brandy.

Caisson à tiroirs en MDF plaqué palissandre de Santos\* teinté Dark Brown, laqué polyester mat avec poignée en bois massif et cache-rosace en métal peint brillant couleur Brandy.

Fond miroir bronze, épaisseur 5 mm.

À l'intérieur du bahut, le long des flancs, il y a 2 barres lumineuses LED avec allumage par interrupteur (alimentation via batteries rechargeables).

**Base :** pieds en tige d'aluminium, Ø 25 mm, peint brillant couleur Brandy et châssis composé de barres en aluminium peint en noir mat. Patins glisseurs en polyéthylène noir.

**N.B. :** au fil du temps, en raison des sautes de température et des variations d'humidité, l'alignement et l'espace entre les différentes lattes pourraient subir de légères modifications.

**\* le palissandre de Santos provient de forêts bien gérées.**

# Minotti

CONTENITORI DINING HIGH/LOW - CONTENITORI LIVING/TV  
DINING HIGH/LOW SIDEBOARDS - LIVING/TV SIDEBOARDS

STRUTTURA PORTANTE  
SUPPORT STRUCTURE

PALISSANDRO SANTOS  
PALISANDER SANTOS

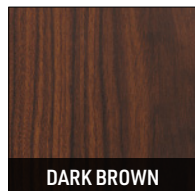

FRASSINO RIGATO  
STREAKED ASH

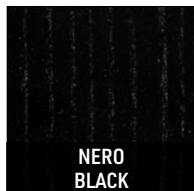

ELEMENTO CONTENITORE (INTERNO - ESTERNO)  
STORAGE ELEMENT (INTERIOR - EXTERIOR)

PALISSANDRO SANTOS  
PALISANDER SANTOS

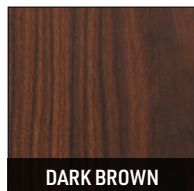

FRASSINO RIGATO  
STREAKED ASH

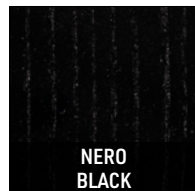

LACCATO LUCIDO  
GLOSSY LACQUERED



MANIGLIE  
HANDLES

ALLUMINIO LUCIDO  
POLISHED ALUMINIUM

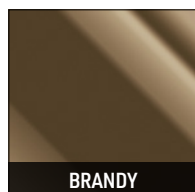

VASSOIO PORTA POSATE  
CUTLERY TRAY

CUOIO  
SADDLE-HIDE

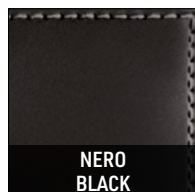

DOGHE  
SLATS

NOCE CANALETTO  
CANALETTO WALNUT

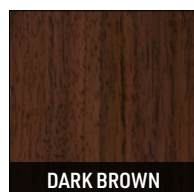

FRASSINO RIGATO  
STREAKED ASH

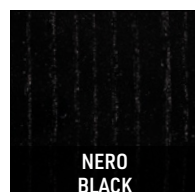

BASI  
BASES

ALLUMINIO LUCIDO  
POLISHED ALUMINIUM

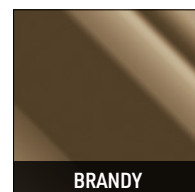

CONTENITORE VERTICALE  
VERTICAL CABINET

STRUTTURA  
STRUCTURE

PALISSANDRO SANTOS  
PALISANDER SANTOS

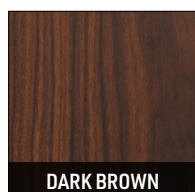

ANTE  
DOORS

VETRO CON RETE  
GLASS WITH MESH

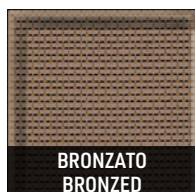

TELAIO ANTE  
DOORS FRAME

ALLUMINIO LUCIDO  
POLISHED ALUMINIUM

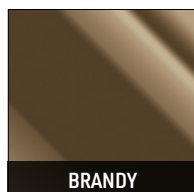

RIPIANI INTERNI  
INTERNAL SHELVES

ALLUMINIO SATINATO  
SATIN ALUMINIUM

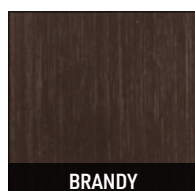

CASSETTI  
DRAWERS

PALISSANDRO SANTOS  
PALISANDER SANTOS

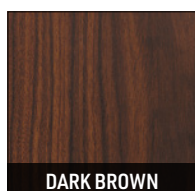

FONDO MANIGLIA  
HANDLE PLATE

METALLO LUCIDO  
POLISHED METAL

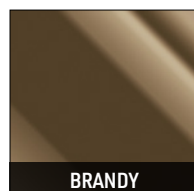

SCHIENALE INTERNO  
INTERNAL BACK

SPECCHIO  
MIRROR

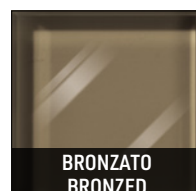

## CONTENITORE DINING HIGH | DINING HIGH SIDEBORD \_ FEET CM 32,5

### STRUTTURA IN PALISSANDRO SANTOS | PALISANDER SANTOS STRUCTURE

#### ELEMENTO CONTENITORE IN PALISSANDRO SANTOS PALISANDER SANTOS STORAGE ELEMENT

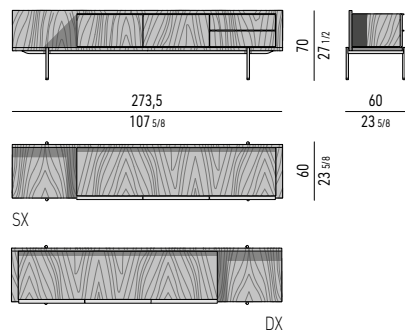

#### ELEMENTO CONTENITORE IN FRASSINO ASH STORAGE ELEMENT

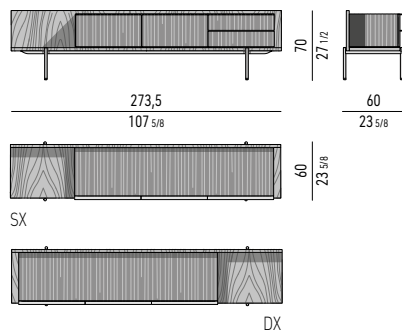

#### ELEMENTO CONTENITORE LACCATO LUCIDO GLOSSY LACQUERED STORAGE ELEMENT

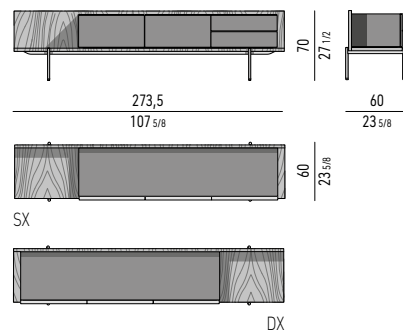

### STRUTTURA IN FRASSINO | ASH STRUCTURE

#### ELEMENTO CONTENITORE IN FRASSINO ASH STORAGE ELEMENT

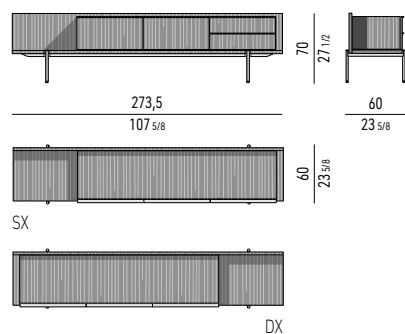

#### ELEMENTO CONTENITORE IN PALISSANDRO SANTOS PALISANDER SANTOS STORAGE ELEMENT

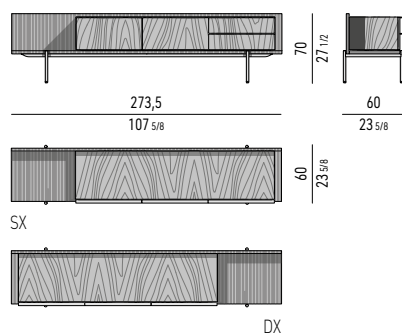

#### ELEMENTO CONTENITORE LACCATO LUCIDO GLOSSY LACQUERED STORAGE ELEMENT

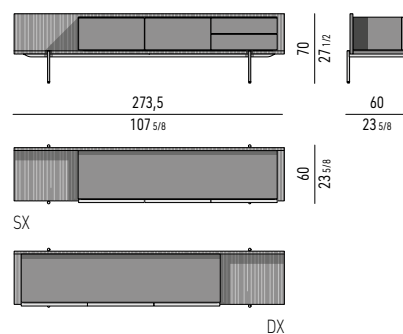

### MISURE INTERNE | INTERNAL MEASUREMENTS

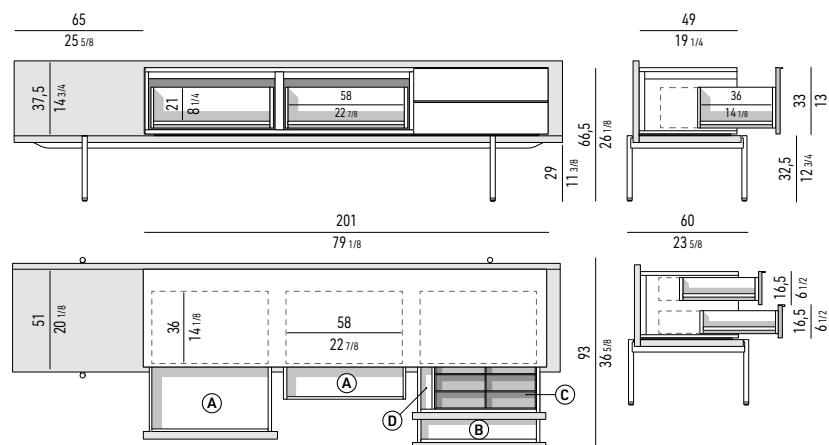

### VASSOIO PORTAPOSATE | CUTLERY TRAY: CM 51X36 H3,5

Scomparto grande | big section: cm 49,5x8,5 H2,5  
Scomparto piccolo | small section cm: 24,5x8 H2,5

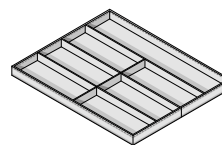

Nr. 4 cassetti che scorrono su guide a estrazione totale con chiusura Blumotion.  
Portata massima per cassetto Kg 30;  
Nr. 1 vassoio portaposate in cuoio color Nero dotato di divisori, riposto nel cassetto (C).

#### Spazio utile interno

Cassetti (A): cm 58x36 H21  
Cassetto (B): cm 58x36 H8  
Vano (D): cm 5,5x36 H8

Nr. 4 drawers that glide on fully extractable guides with Blumotion soft-close system.  
Maximum load per drawer is 30 Kg;  
Nr. 1 cutlery tray in Black colour saddle-hide, with dividers, located in the (C) drawer.

#### Internal dimension

Drawers (A): cm 58x36 H21  
Drawer (B): cm 58x36 H8  
Compartment (D): cm 5,5x36 H8

## CONTENITORE DINING LOW | DINING LOW SIDEBBOARD \_ FEET CM 22

### STRUTTURA IN PALISSANDRO SANTOS | PALISANDER SANTOS STRUCTURE

#### ELEMENTO CONTENITORE IN PALISSANDRO SANTOS PALISANDER SANTOS STORAGE ELEMENT

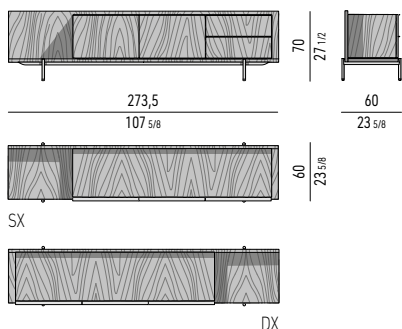

#### ELEMENTO CONTENITORE IN FRASSINO ASH STORAGE ELEMENT

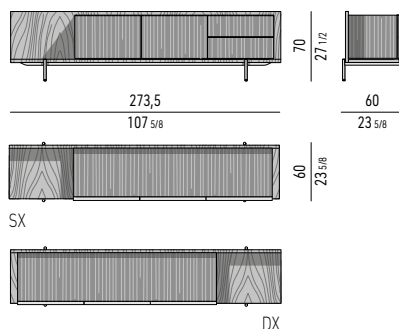

#### ELEMENTO CONTENITORE LACCATO LUCIDO GLOSSY LACQUERED STORAGE ELEMENT

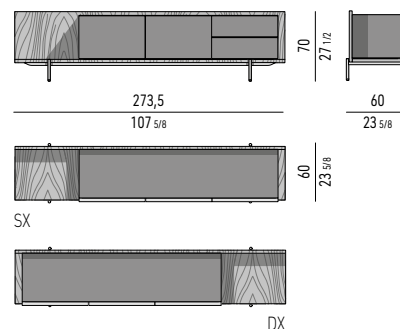

### STRUTTURA IN FRASSINO | ASH STRUCTURE

#### ELEMENTO CONTENITORE IN FRASSINO ASH STORAGE ELEMENT

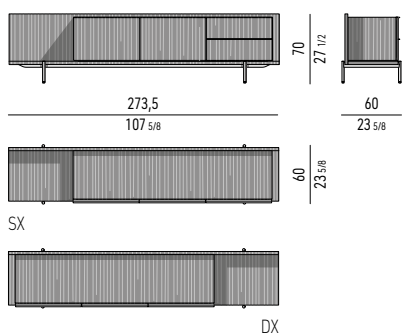

#### ELEMENTO CONTENITORE IN PALISSANDRO SANTOS PALISANDER SANTOS STORAGE ELEMENT

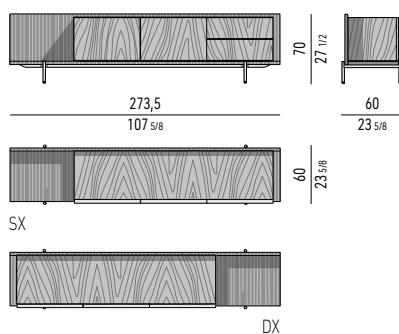

#### ELEMENTO CONTENITORE LACCATO LUCIDO GLOSSY LACQUERED STORAGE ELEMENT

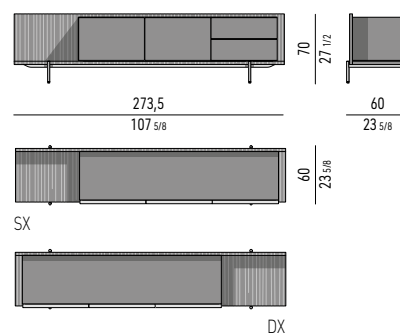

### MISURE INTERNE | INTERNAL MEASUREMENTS

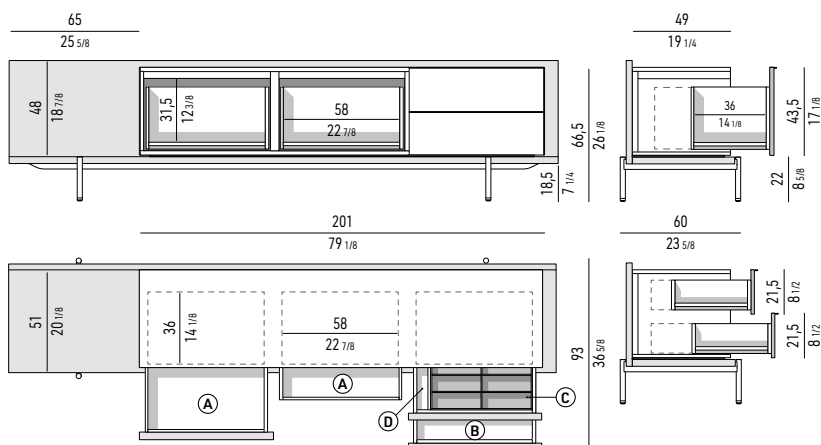

### VASSOIO PORTAPOSATE | CUTLERY TRAY: CM 51X36 H3,5

Scomparto grande | big section: cm 49,5x8,5 H2,5  
Scomparto piccolo | small section: cm 24,5x8 H2,5

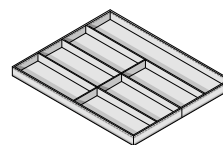

Nr. 4 cassetti che scorrono su guide a estrazione totale con chiusura Blumotion.  
Portata massima per cassetto Kg 30;  
Nr. 1 vassoio portaposate in cuoio color Nero dotato di divisori, riposto nel cassetto (C).  
**Spazio utile interno**  
Cassetti (A): cm 58x36 H31,5  
Cassetto (B): cm 58x36 H13  
Vano (D): cm 5,5x36 H11,5

Nr. 4 drawers that glide on fully extractable guides with Blumotion soft-close system.  
Maximum load per drawer is 30 Kg;  
Nr. 1 cutlery tray in Black colour saddle-hide, with dividers, located in the (C) drawer.  
**Internal dimension**  
Drawers (A): cm 58x36 H31,5  
Drawer (B): cm 58x36 H13  
Compartment (D): cm 5,5x36 H11,5

## CONTENITORE LIVING/TV | LIVING/TV SIDEBOARD

### STRUTTURA IN PALISSANDRO SANTOS | PALISANDER SANTOS STRUCTURE

ELEMENTO CONTENITORE IN **PALISSANDRO SANTOS**  
**PALISANDER SANTOS** STORAGE ELEMENT

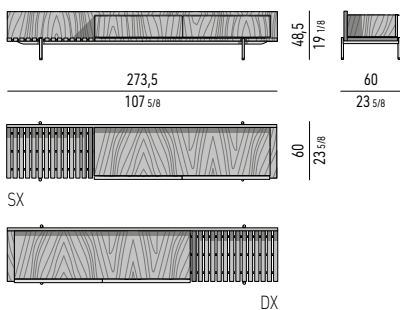

ELEMENTO CONTENITORE IN **FRASSINO**  
**ASH** STORAGE ELEMENT

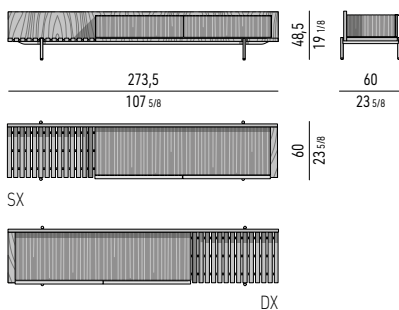

ELEMENTO CONTENITORE **LACCATO LUCIDO**  
**GLOSSY LACQUERED** STORAGE ELEMENT

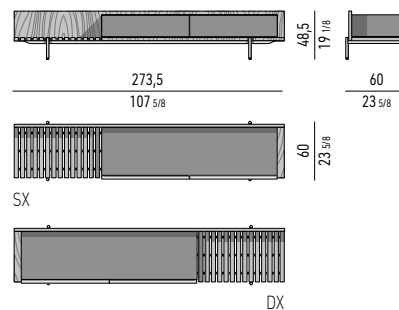

### STRUTTURA IN FRASSINO | ASH STRUCTURE

ELEMENTO CONTENITORE IN **FRASSINO**  
**ASH** STORAGE ELEMENT

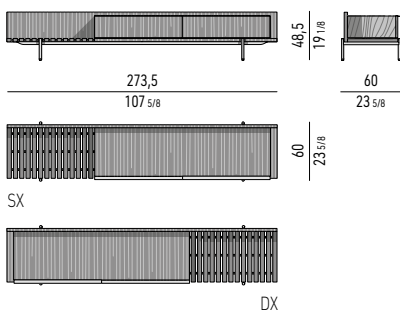

ELEMENTO CONTENITORE IN **PALISSANDRO SANTOS**  
**PALISANDER SANTOS** STORAGE ELEMENT

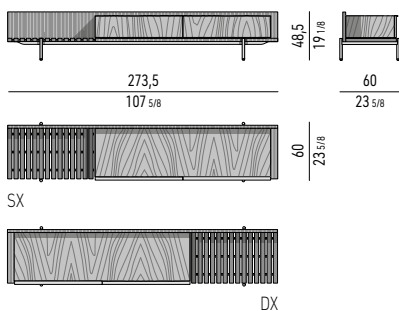

ELEMENTO CONTENITORE **LACCATO LUCIDO**  
**GLOSSY LACQUERED** STORAGE ELEMENT

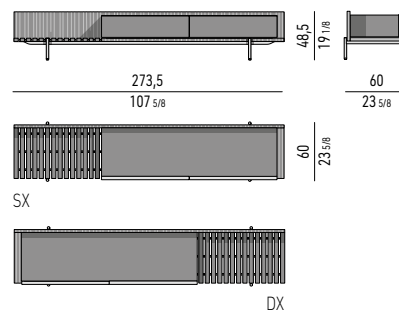

### MISURE INTERNE | INTERNAL MEASUREMENTS

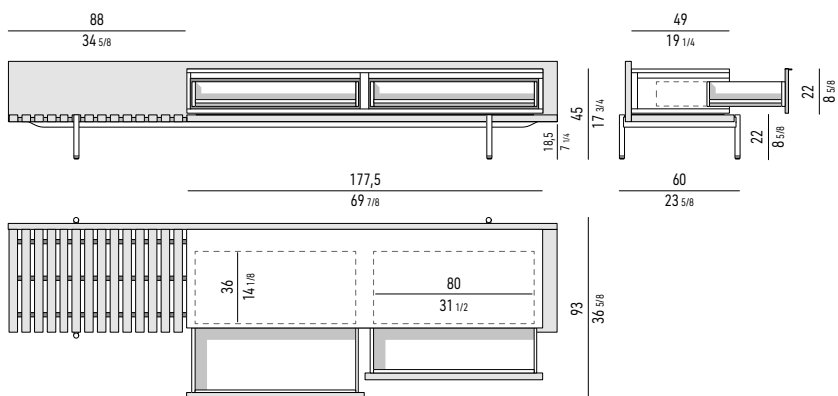

Nr. 2 cassetti che scendono su guide a estrazione totale con chiusura Blumotion.  
Portata massima per cassetto Kg 30.

**Spazio utile interno cassetti**  
cm 80x36 H11

Nr. 2 drawers that glide on fully extractable guides with Blumotion soft-close system.  
Maximum load per drawer is 30 Kg.

**Drawers internal dimension**  
cm 80x36 H11

## CONTENITORE VERTICALE | VERTICAL CABINET

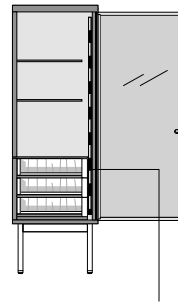
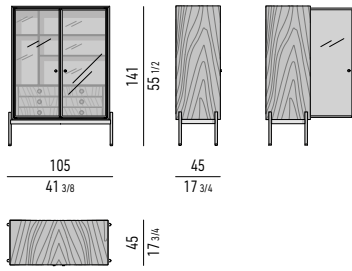

ILLUMINAZIONE A LED  
LED LIGHTING

INTERRUTTORE  
SWITCH

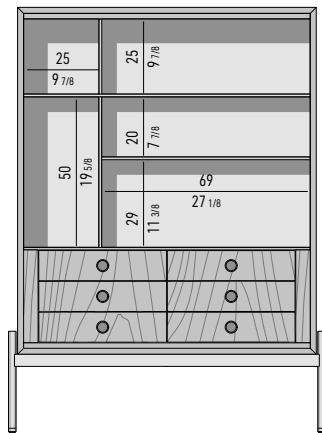
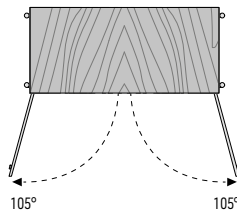

22  
8 <sup>5</sup>/<sub>8</sub>  
26,5  
10 <sup>1</sup>/<sub>2</sub>

### MISURE INTERNE | INTERNAL MEASUREMENTS

N. 6 cassetti che scorrono su guide a estrazione totale con chiusura Blumotion.

Portata massima per cassetto Kg 30.

**Spazio utile interno cassetti**  
cm 36x26 H6

N. 6 drawers that glide on fully extractable guides with Blumotion soft-close system.

Maximum load per drawer is 30 Kg.

**Drawers internal dimension**  
cm 36x26 H6