



Struttura: in legno multistrato di vari spessori. Preparazione della struttura sedile in poliuretano espanso a quote differenziate ad alta densità. Braccioli e schienali realizzati in legno multistrati di vari spessori, rivestiti con poliuretano espanso a quote differenziate ad alta densità. Braccioli e schienali rivestiti successivamente con trapuntino in piuma d'oca canalizzata, sottoposta a regolare trattamento di bonifica igienico-sanitaria come stabilito dal Regolamento CE 1069/2009 (certificata Assopiuma, Etichetta Oro) che conferisce elevata morbidezza e sofficià.

Il rivestimento della base strutturale in pelle è realizzato con fasce, lavorate con la stessa tecnica usata per la valigeria ed è caratterizzato da accurate cuciture rifinite a mano.

Flap: il sistema di sedute Connery propone elementi con integrati dei piani di appoggio dal minimale impatto visivo, che conferiscono un vivace ritmo alle composizioni. Si tratta di elementi ottenuti dalla piegatura di lastre di alluminio, spessore mm 8, rivestiti in pelle con concetto di pelletteria o impiallacciati in frassino laccato a poro aperto color Moka.

Cuscineria: imbottitura cuscini schienale e sedile in piuma d'oca canalizzata, sottoposta a regolare trattamento di bonifica igienico-sanitaria come stabilito dal Regolamento CE 1069/2009 (certificata Assopiuma, Etichetta Oro) con inserto in poliuretano a quote differenziate. La confezione del cuscino sedile e della sua fodera interna vengono realizzate con una leggera trapuntatura realizzata con un doppio ricamo e un'impuntura quilt, che enfatizza la forma lineare ma al contempo morbida della seduta.

Sfoderabilità: struttura, cuscini sedile e schienale completamente sfoderabili in tutte le versioni (tessuto o pelle).

Basi: lame portanti in estruso di alluminio spazzolato e verniciato lucido color Brandy. Scivolanti in polietilene di colore nero.

Per facilitare la sfoderabilità, gli elementi schienale/bracciolo e i Flap sono facilmente sfilabili dalle loro sedi agendo sulle apposite manopole poste nella parte sottostante i divani.

La verniciatura "brandy", messa a punto da Minotti Studio e proposta in esclusiva, è ottenuta da una lavorazione manuale di estrema qualità che risalta la spazzolatura lucida dell'alluminio includendo possibili naturali sfumature che rendono unico ogni pezzo.

Structure: in plywood of various thicknesses. The seat structure is coated in high-resilience variable-density polyurethane foam. Armrests and backrests in plywood of various thicknesses, coated in high-resilience variable-density polyurethane foam. Armrests and backrests are then encased in channeled goose down quilting (Assopiuma Gold Label certified) for added softness, and undergo routine sanitization as specified in EC Regulation No. 1069/2009. The structural base is sheathed in strips of leather, tailored using the same techniques used for fine luggage, and features hand-finished stitching.

Flap: the Connery seating system includes pieces that incorporate low visual impact Flap table top surfaces that lend lively rhythm to the arrangements. Made of bent 8 mm thick aluminium sheet, upholstered in leather in the style of fine leather goods, or in ash veneer with open-pore Moka colour lacquer finish.

Cushions: backrest and seat cushions in channeled goose down (Assopiuma Gold Label certified) undergo routine sanitization as specified in EC Regulation No. 1069/2009, with variable-density polyurethane foam insert for added softness. The seat cushion and its internal casing are crafted with a subtle quilted pattern with double embroidery and quilt stitching that highlights the linear yet soft shape of the seat.

Covers: structure, seat and backrest cushion covers are completely removable in all versions (fabric and leather).

Bases: weight-bearing blades in extruded brushed aluminium with polished varnished Brandy colour finish.

Black polyethylene glides.

Coverings of the backrest/armrest elements can easily be removed by releasing the levers located underneath the sofas.

The exclusive "Brandy" varnished finish, developed by Minotti Studio, is achieved through an exclusive high-quality hand-finishing process that emphasizes the polished brushed aluminium texture, including possible natural nuances that make each piece unique.

Struktur: aus Sperrholz verschiedener Stärken. Polsterung des Gestells der Sitzfläche aus PU-Schaum mit differenzierter, hoher Dichte. Armlehnen und Rückenlehnen aus Sperrholz mit unterschiedlicher Dichte und Polsterung aus PU-Schaum mit differenzierter, hoher Dichte. Zusätzliche Polsterung der Armlehnen und Rückenlehnen mit gesteppter Daunenfüllung mit Kammern und Innenstegen und Sterilisierung der Füllung nach Vorgabe der Verordnung (EU) 1069/2009 (zertifiziert Assopiuma, "Goldenes Etikett") für einen angenehm weichen Sitzkomfort. Der Lederbezug des Unterbaus ist in Streifen ausgeführt, die mit der gleichen Technik verarbeitet werden, die auch bei der Lederwarenherstellung eingesetzt wird und durch sorgfältige, von Hand ausgeführte Nähte charakterisiert ist.

Flap: Das Sofasystem Connery umfasst Elemente mit integrierten Ablageflächen in diskretem Design, mit denen sich die Kombination auflockern lässt.

Diese Elemente bestehen aus einer 8 mm dicken, gebogenen Aluminiumplatte mit Lederbezug mit feinsten Lederwarenverarbeitung und mit Eschenfurnier mit offener Lackierung in der Farbe Mokka.

Kissen: Rückenkissen und Sitzkissen mit gesteppter Daunenfüllung mit Kammern und Innenstegen und Sterilisierung der Füllung nach Vorgabe der Verordnung (EU) 1069/2009 (zertifiziert Assopiuma, "Goldenes Etikett"), mit Kern aus PU-Schaum mit differenzierter Dichte. Das Sitzkissen und das Innenfutter werden mit einer leichten Steppung mit Doppelnaht und Quiltstich ausgeführt, die die lineare und zugleich weiche Form der Sitzfläche hervorheben.

Abziehbarkeit: Gestell, Sitzkissen und Rückenkissen sind in allen Versionen (Stoff oder Leder) komplett abziehbar.

Grundgestell: Tragende Profile aus extrudiertem Aluminium, gebürstet und mit glänzender Lackierung in der Farbe Brandy. Gleiter aus Polyethylen in Schwarz.

Für ein einfaches Abziehen vom Bezug lassen sich die Rückenlehne/Armlehne und die Flap-Elemente einfach aus ihrem Sitz herausziehen. Dazu die entsprechenden Drehknöpfe betätigen, die sich unter dem Sofa befinden.

Die Lackierung "Brandy", die von Minotti Studio entwickelt wurde und exklusiv für dieses Produkt erhältlich ist, wird in einer sehr hochwertigen Bearbeitung in Handarbeit ausgeführt und betont die glänzende gebürstete Oberfläche des Aluminiums. Bei der Bearbeitung können sich natürliche Farbnuancen ergeben, die jedes Stück zu einem Einzelstück machen.

Structure : en multiplis de différentes épaisseurs. Préparation de la structure d'assise en polyuréthane expansé à densité différenciée haute résilience. Accoudoirs et dossiers en multiplis de différentes épaisseurs, recouverts de polyuréthane expansé à densité différenciée haute résilience. Accoudoirs et dossiers recouverts ensuite d'un édredon garni de plume d'oie cloisonnée, soumise à un traitement d'assainissement conformément au Règlement CE 1069/2009 (certifié Assopiuma, Label Or) qui apporte beaucoup de douceur et de moelleux.

Le revêtement du piètement en cuir est fait de bandes confectionnées selon la technique maroquinier, et caractérisé par des coutures minutieuses, finies à la main.

Flap : le système de sièges Connery peut intégrer des éléments faisant office de tablettes dont l'impact visuel est minimal et qui rythment énergiquement les compositions. Ces éléments sont obtenus par pliage de plaques d'aluminium de 8 mm d'épaisseur, recouvertes de cuir selon la technique maroquinier ou plaquées frêne laqué à pores ouverts de couleur Moka.

Coussins : rembourrage des coussins de dossier et d'assise en plume d'oie cloisonnée, soumise à un traitement d'assainissement conformément au Règlement CE 1069/2009 (certifié Assopiuma, Label Or) avec insert en polyuréthane à densité différenciée. La confection du coussin d'assise et de sa housse intérieure est réalisée avec un matelassage léger consistant en une broderie double et une surpiqué effet matelassé, qui souligne la forme à la fois linéaire et douce de l'assise.

Déhoussage : structure, coussins d'assise et de dossier entièrement déhoussables dans toutes les versions (tissu ou cuir).

Bases : lames porteuses en aluminium extrudé brossé et peint brillant de couleur Brandy. Patins glisseurs en polyéthylène noir.

Pour faciliter le déhoussage, les éléments dossier/accoudoir et les Flap peuvent être facilement retirés de leur logement en tournant les poignées situées sous le canapé.

La peinture « Brandy », mise au point par Minotti Studio et proposée en exclusivité, est le résultat d'un procédé manuel de très haute qualité qui rehausse le brossage brillant de l'aluminium en incluant d'éventuelles nuances naturelles qui rendent chaque pièce unique.

Minotti

AVVERTENZE SULLA CONFEZIONE DELLA FODERA

A) Rivestimento tutto in tessuto; FLAP (ove previsto) realizzato in pelle Aspen. Rivestimento tutto in pelle; FLAP (ove previsto) realizzato nella medesima pelle prevista per il rivestimento.

B) Rivestimento della base in pelle Aspen, schienale, cuscini sedile e schienale in tessuto; FLAP (ove previsto) realizzato in pelle Aspen.

C) Rivestimento tutto in tessuto o tutto in pelle; FLAP realizzato in frassino color Moka.

D) Rivestimento della base in pelle Aspen, schienale, cuscini sedile e schienale in tessuto; FLAP in frassino color Moka.

N.B.: data la delicatezza delle pelli, si consiglia di non appoggiare bicchieri od oggetti direttamente sul Flap, ma di utilizzare il vassoio Connery optional.

POGGIATESTA

Realizzato in multistrato rivestito in poliuretano espanso ad alta densità, successivamente rivestito con fibra termolegata traspirante accoppiata con tela di cotone bianca.

Per migliorare l'aderenza dell'elemento alla seduta, all'interno della fascia, in corrispondenza del cuscino sedile, è stato inserito un contrappeso.

Tessuto antiscivolo sul fondo. Completamente sfoderabile.

VASSOIO

In alluminio impiallacciato rovere laccato a poro aperto colore Moka e cornice in metallo con finitura color Black-Nickel. Scivolante in feltro.

INFORMATION REGARDING UPHOLSTERY AND COVERS

A) All-fabric upholstery; FLAP (where included) in Aspen leather.

All-leather upholstery; FLAP (where included) made of the same leather as the upholstery.

B) Base upholstered in Aspen leather, backrest, seat and backrest cushions in fabric; FLAP (where included) in Aspen leather.

C) All-fabric or all-leather upholstery; FLAP in Moka colour ash.

D) Base upholstered in Aspen leather, backrest, seat and backrest cushions in fabric; FLAP in Moka colour ash.

N.B.: because leathers are fairly delicate, we recommend not setting drinking glasses or objects directly on the Flap, but instead use the optional Connery tray.

HEADREST

Made of plywood coated in high-resilience polyurethane foam, then sheathed in breathable, heat-bonded fiber laminated to white cotton canvas. To improve adherence of the element to the seat, a counterweight is inserted inside the fabric strip where it meets the seat cushion.

Non-slip fabric on the bottom. Cover completely removable.

TRAY

Aluminium with oak veneer, open-pore Moka lacquer finish and metal frame with Black-Nickel colour finish. Felt glides.

HINWEISE ZUR KONFEKTIONIERUNG DES BEZUGS

A) Bezug komplett aus Stoff.

FLAP (falls vorgesehen) mit Bezug aus Aspen-Leder.

Bezug komplett aus Leder. FLAP (falls vorgesehen) mit Bezug aus dem gleichen Leder wie der Bezug.

B) Bezug vom Unterbau aus Aspen-Leder, Rückenlehne, Sitzkissen und Rückenkissen mit Stoffbezug. FLAP (falls vorgesehen) mit Bezug aus Aspen-Leder.

C) Bezug komplett aus Stoff oder komplett aus Leder. FLAP mit Eschenfurnier in der Farbe Mokka.

D) Bezug vom Unterbau aus Aspen-Leder, Rückenlehne, Sitzkissen und Rückenkissen mit Stoffbezug. FLAP mit Eschenfurnier in der Farbe Mokka.

N.B.: Die Lederoberfläche der Flaps ist sehr empfindlich. Gläser oder Gegenstände sollten deshalb nicht direkt auf die FLAP gelegt werden. Es wird empfohlen, das Tablett Connery zu verwenden, das zusätzlich erhältlich ist.

KOPFSTÜTZE

Aus Sperrholz mit Beschichtung aus PU-Schaum mit hoher Dichte, Polsterung mit atmungsaktiver temperaturregulierter Faser und Bezug aus weißer Baumwolle. Damit die Kopfstütze perfekt an der Sitzfläche anliegt, befindet sich im Band auf Höhe des Sitzkissens ein Gegengewicht. Rutschfestes Gewebe am Boden des Elements. Komplet abziehbar.

TABLETT

Aus Aluminium furniert mit Eiche mit offenporiger Lackierung in der Farbe Mokka und Metallrahmen mit Oberfläche in der Farbe Black-Nickel. Filzgleiter.

NOTES SUR LA CONFECTION DE LA HOUSSE

A) Revêtement tout en tissu ; FLAP (le cas échéant) réalisé en cuir Aspen. Revêtement tout en cuir ; FLAP (le cas échéant) réalisé dans le même cuir que le revêtement.

B) Revêtement du piètement en cuir Aspen, dossier, coussins d'assise et de dossier en tissu ; FLAP (le cas échéant) réalisé en cuir Aspen.

C) Revêtement tout en tissu ou tout en cuir ; FLAP réalisé en frêne de couleur Moka.

D) Revêtement du piètement en cuir Aspen, dossier, coussins d'assise et de dossier en tissu ; FLAP réalisé en frêne de couleur Moka.

N.B. : étant donné la délicatesse des cuirs, il est conseillé de ne pas poser de verres ni d'objets directement sur le Flap mais d'utiliser le plateau Connery en option.

APPUI-TÊTE

Fabriqué en multiplis recouvert de polyuréthane expansé haute densité, puis de fibre thermocollée respirante doublée de toile de coton blanche.

Pour améliorer l'adhérence de l'élément à l'assise, un contrepoids a été inséré à l'intérieur de la bande, au niveau du coussin d'assise.

Tissu antidérapant sur le bas. Entièrement déhoussable.

PLATEAU

En aluminium plaqué chêne laqué à pores ouverts de couleur Moka et cadre en métal finition Black-Nickel. Patins glisseurs en feutre.

BASI BASES

ALLUMINIO ALUMINIUM

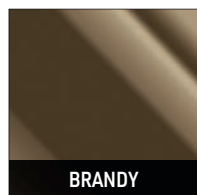

BRANDY

ELEMENTO FLAP FLAP ELEMENT

PELLE LEATHER

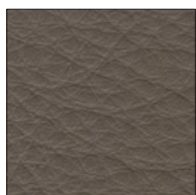

FRASSINO ASH

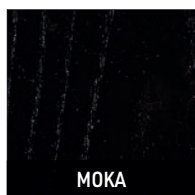

MOKA

VASSOIO | TRAY

STRUTTURA STRUCTURE

ROVERE OAK

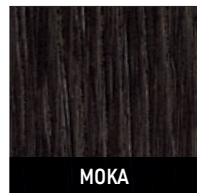

MOKA

CORNICE FRAME

METALLO METAL

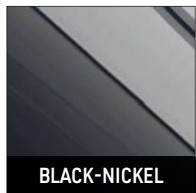

BLACK-NICKEL

* IN CASO DI FLAP IN PELLE, È CONSIGLIATO L'UTILIZZO DEL VASSOIO OPTIONAL.

* IN CASE OF LEATHER FLAP, THE USE OF THE OPTIONAL TRAY IS RECOMMENDED.

VASSOIO | TRAY *



MODULO DI SEDUTA CM 83 | SEATING MODULE CM 83

DIVANI | SOFAS

DIVANO CM 214
SOFA CM 214

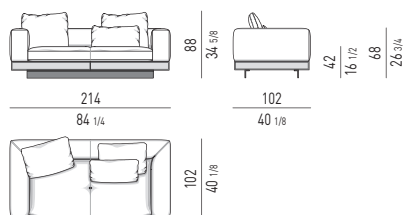

DIVANO CM 297
SOFA CM 297

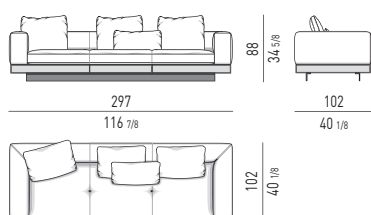

DIVANI-DAYBED | DAYBED-SOFAS

DIVANO-DAYBED CON FLAP CM 297
DAYBED-SOFA WITH FLAP CM 297

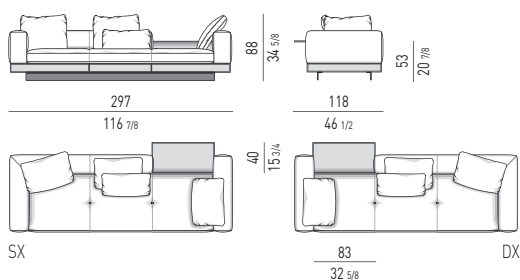

DIVANO CON FLAP CM 230
SOFA WITH FLAP CM 230

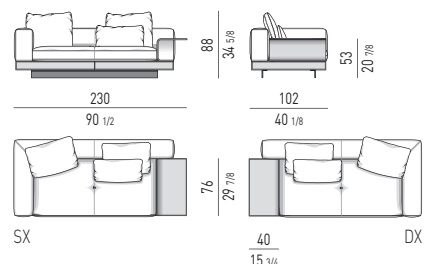

DIVANO CON FLAP CM 313
SOFA WITH FLAP CM 313

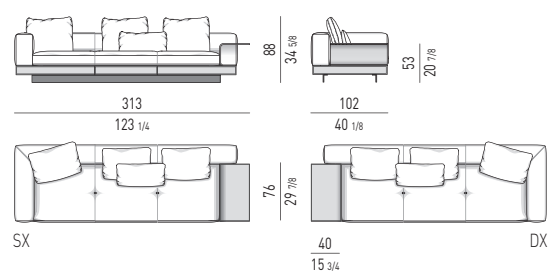

ELEMENTO DAYBED CON FLAP CM 275
DAYBED ELEMENT WITH FLAP CM 275

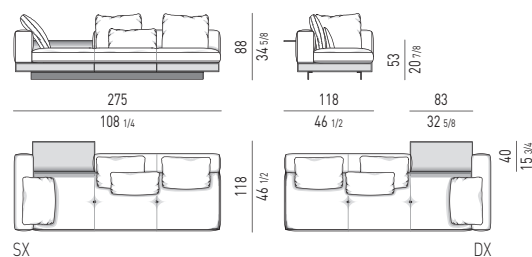

ELEMENTI TERMINALI | ELEMENTS WITH 1 ARMREST

ELEMENTO TERMINALE CM 192
ELEMENT WITH 1 ARMREST CM 192

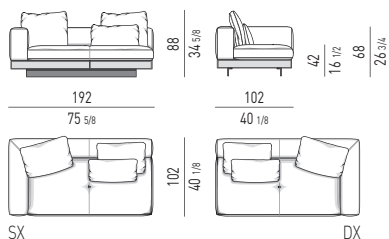

ELEMENTO TERMINALE CON FLAP CM 208
ELEMENT WITH 1 ARMREST AND FLAP CM 208

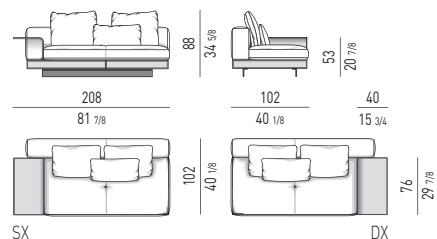

ELEMENTO TERMINALE CM 275
ELEMENT WITH 1 ARMREST CM 275

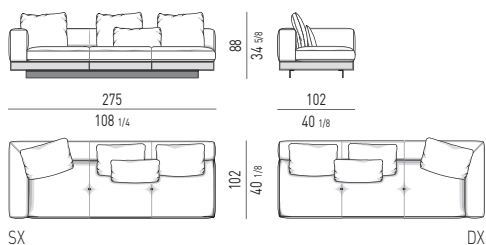

ELEMENTO TERMINALE CON FLAP CM 291
ELEMENT WITH 1 ARMREST AND FLAP CM 291

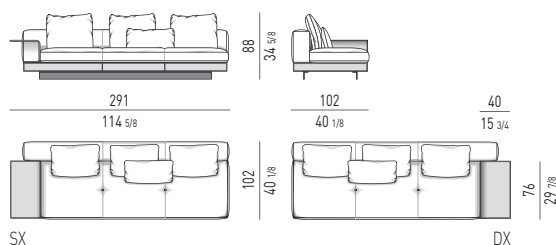

Minotti

ELEMENTO TERMINALE OPEN CON **FLAP CM 275**
OPEN ELEMENT WITH 1 ARMREST AND **FLAP CM 275**

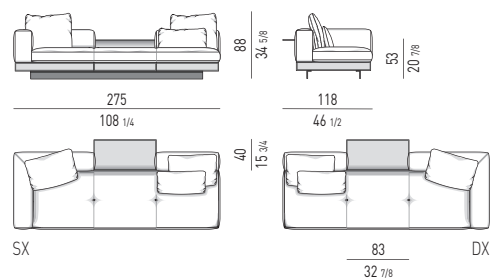

ELEMENTI TERMINALI PENISOLA | OPEN-END ELEMENTS WITH 1 ARMREST

ELEMENTO TERMINALE PENISOLA CON **FLAP CM 192**
OPEN-END ELEMENT WITH 1 ARMREST AND **FLAP CM 192**

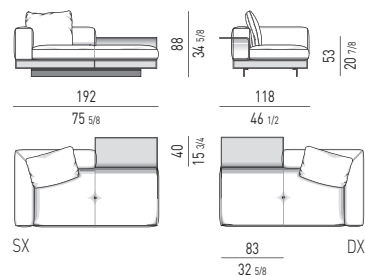

ELEMENTO TERMINALE PENISOLA CON **FLAP CM 275**
OPEN-END ELEMENT WITH 1 ARMREST AND **FLAP CM 275**

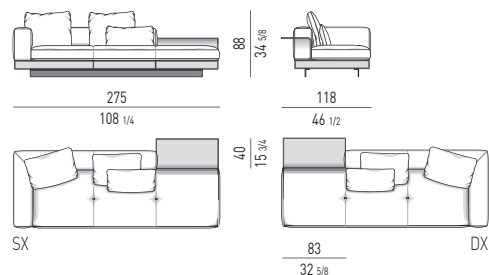

ELEMENTI PENISOLA | OPEN-END ELEMENTS

ELEMENTO PENISOLA CM **170**
OPEN-END ELEMENT CM **170**

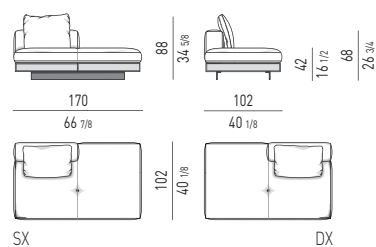

ELEMENTO PENISOLA CON **FLAP CM 170**
OPEN-END ELEMENT WITH **FLAP CM 170**

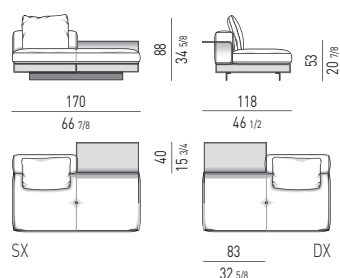

ELEMENTO PENISOLA CM **253**
OPEN-END ELEMENT CM **253**

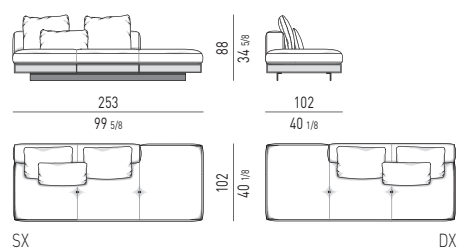

ELEMENTO PENISOLA CON **FLAP CM 253**
OPEN-END ELEMENT WITH **FLAP CM 253**

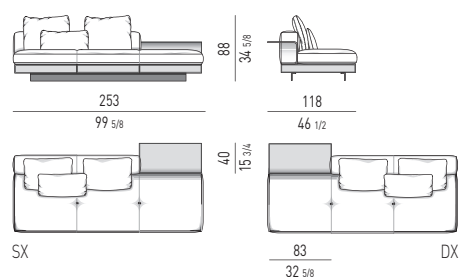

ELEMENTI CENTRALI | CENTRAL ELEMENTS

ELEMENTO CENTRALE CM **170**
CENTRAL ELEMENT CM **170**

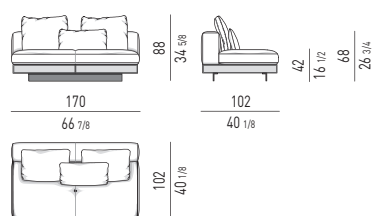

ELEMENTO CENTRALE CM **253**
CENTRAL ELEMENT CM **253**

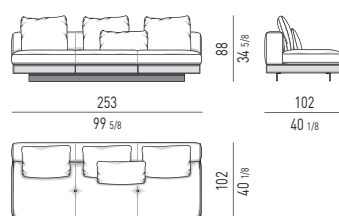

ELEMENTO CENTRALE OPEN CON **FLAP CM 253**
OPEN CENTRAL ELEMENT WITH **FLAP CM 253**

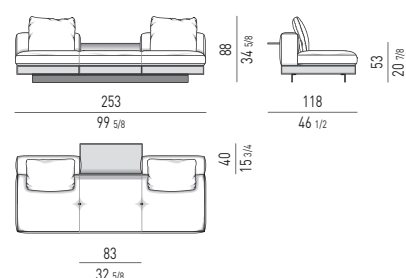

Minotti

DIVANI ANGOLARI | CORNER SOFAS

DIVANO ANGOLARE CM **208X102**
CORNER SOFA CM **208X102**

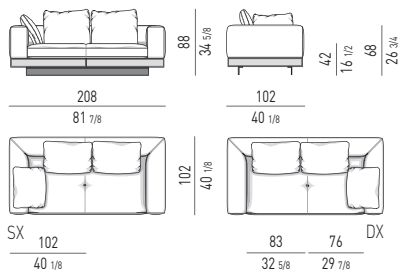

DIVANO ANGOLARE CON **FLAP** CM **224X102**
CORNER SOFA WITH **FLAP** CM **224X102**

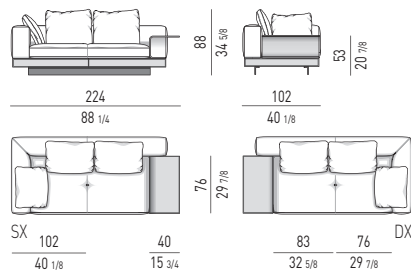

DIVANO ANGOLARE CM **291X102**
CORNER SOFA CM **291X102**

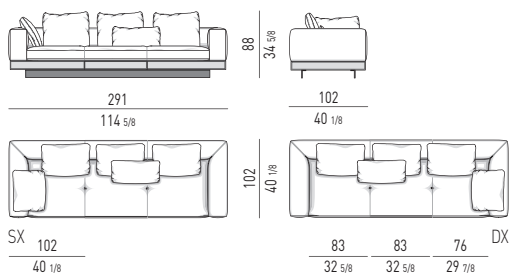

DIVANO ANGOLARE CON **FLAP** CM **307X102**
CORNER SOFA WITH **FLAP** CM **307X102**

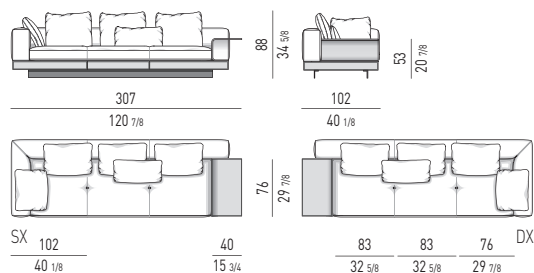

DIVANI ANGOLARI-DAYBED | CORNER SOFAS-DAYBED

DIVANO ANGOLARE-DAYBED CON **FLAP** CM **291X118** - SCHIENALE CM **182**
CORNER SOFA-DAYBED WITH **FLAP** CM **291X118** - BACKREST CM **182**

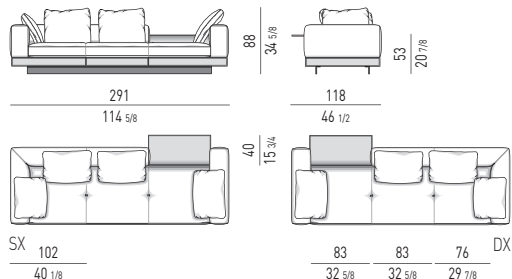

DIVANO ANGOLARE-DAYBED CON **FLAP** CM **291X118** - SCHIENALE CM **189**
CORNER SOFA-DAYBED WITH **FLAP** CM **291X118** - BACKREST CM **189**

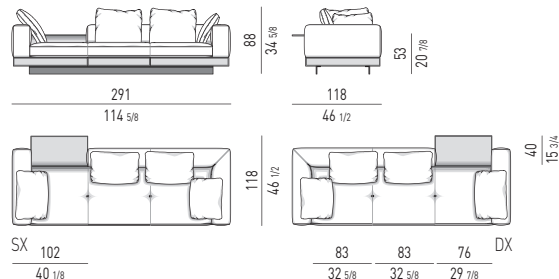

ELEMENTO ANGOLARE TERMINALE-DAYBED | CORNER ELEMENT WITH 1 ARMREST-DAYBED

ELEMENTO ANGOLARE TERMINALE-DAYBED CON **FLAP** CM **269X118**
CORNER ELEMENT WITH 1 ARMREST-DAYBED AND **FLAP** CM **269X118**

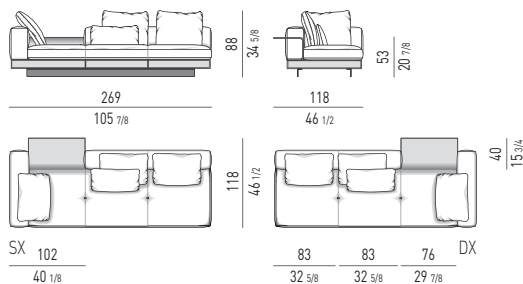

ELEMENTI ANGOLARI TERMINALI | CORNER ELEMENTS WITH 1 ARMREST

ELEMENTO ANGOLARE TERMINALE CM **186X102**
CORNER ELEMENT WITH 1 ARMREST CM **186X102**

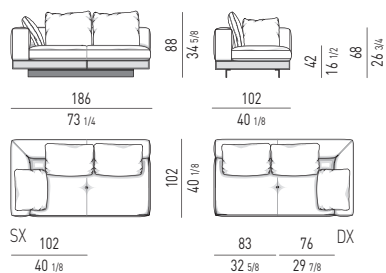

ELEMENTO ANGOLARE TERMINALE CM **269X102**
CORNER ELEMENT WITH 1 ARMREST CM **269X102**

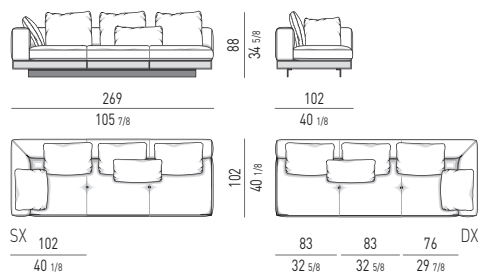

ELEMENTI ANGOLARI TERMINALI PENISOLA | CORNER OPEN-END ELEMENTS WITH 1 ARMREST

ELEMENTO ANGOLARE TERMINALE PENISOLA CM **186X102**
CORNER OPEN-END ELEMENT WITH 1 ARMREST CM **186X102**

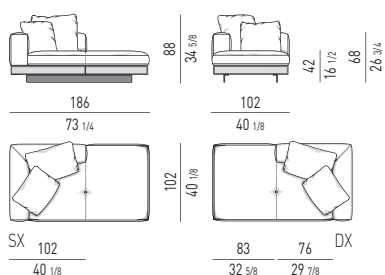

ELEMENTO ANGOLARE TERMINALE PENISOLA CON **FLAP** CM **186X118**
CORNER OPEN-END ELEMENT WITH 1 ARMREST AND **FLAP** CM **186X118**

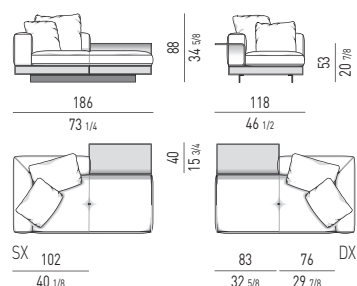

ELEMENTO ANGOLARE TERMINALE PENISOLA CM **269X102**
CORNER OPEN-END ELEMENT WITH 1 ARMREST CM **269X102**

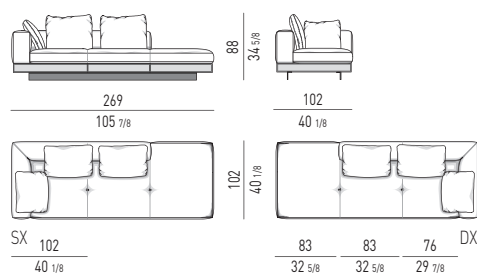

ELEMENTO ANGOLARE TERMINALE PENISOLA CON **FLAP** CM **269X118**
CORNER OPEN-END ELEMENT WITH 1 ARMREST AND **FLAP** CM **269X118**

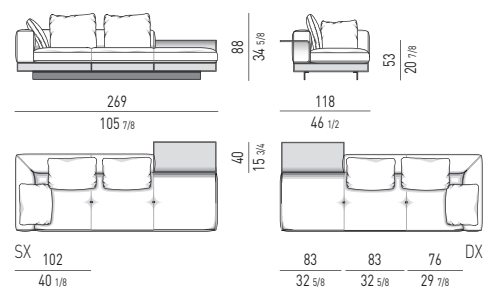

PANCHE | BENCHES

PANCA CON BRACCIOLLO CM **192X80**
BENCH WITH ARMREST CM **192X80**

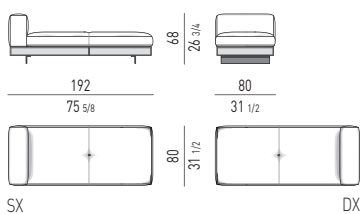

PANCA CON **FLAP** CM **208X80**
BENCH WITH **FLAP** CM **208X80**

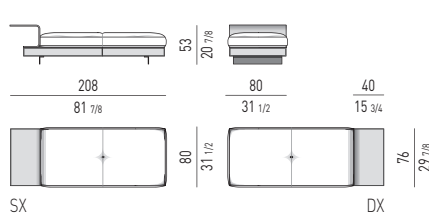

PANCA CM **170X80**
BENCH CM **170X80**

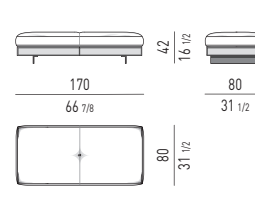

POUF | OTTOMAN

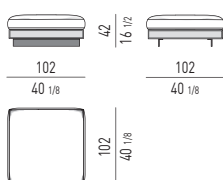

MODULO DI SEDUTA CM 68 | SEATING MODULE CM 68

DIVANI | SOFAS

DIVANO CM 184
SOFA CM 184

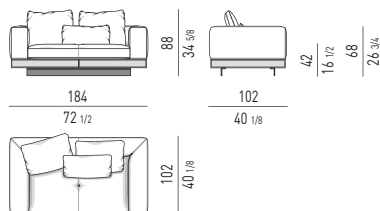

DIVANO CM 252
SOFA CM 252

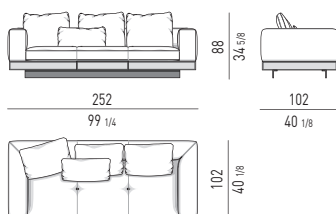

DIVANI-DAYBED | DAYBED-SOFAS

DIVANO-DAYBED CON FLAP CM 252
DAYBED-SOFA WITH FLAP CM 252

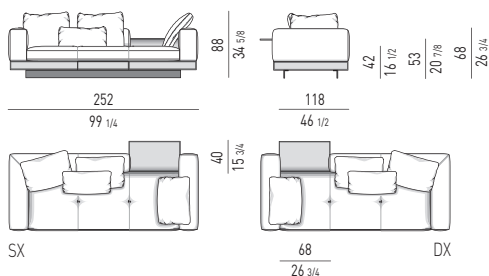

DIVANO CON FLAP CM 200
SOFA WITH FLAP CM 200

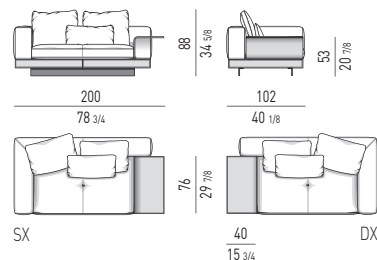

DIVANO CON FLAP CM 268
SOFA WITH FLAP CM 268

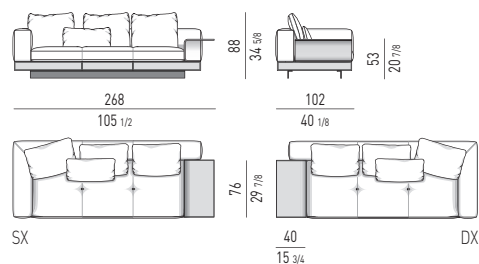

ELEMENTI TERMINALI | ELEMENTS WITH 1 ARMREST

ELEMENTO TERMINALE CM 162
ELEMENT WITH 1 ARMREST CM 162

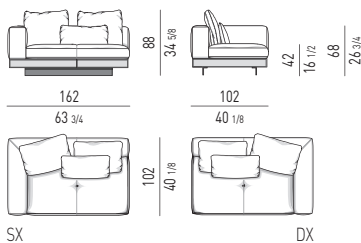

ELEMENTO TERMINALE CON FLAP CM 178
ELEMENT WITH 1 ARMREST AND FLAP CM 178

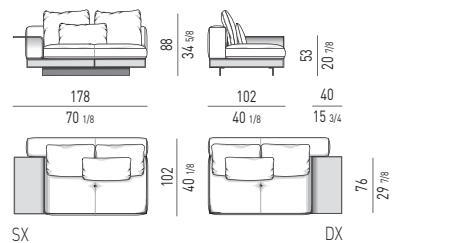

ELEMENTO TERMINALE CM 230
ELEMENT WITH 1 ARMREST CM 230

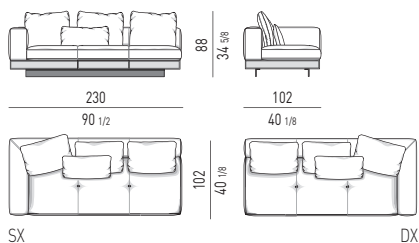

ELEMENTO TERMINALE CON FLAP CM 246
ELEMENT WITH 1 ARMREST AND FLAP CM 246

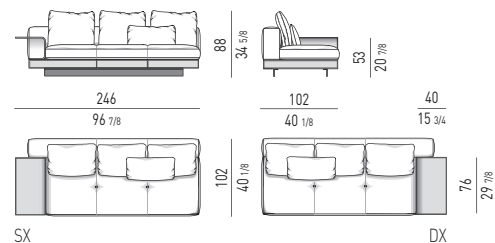

Minotti

ELEMENTO TERMINALE OPEN CON FLAP CM 230 OPEN ELEMENT WITH 1 ARMREST AND FLAP CM 230

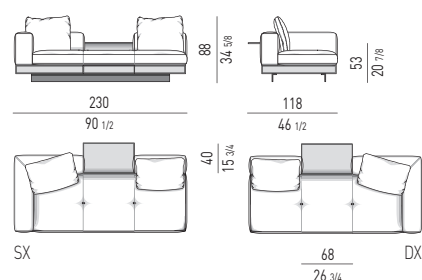

ELEMENTI TERMINALI PENISOLA | OPEN-END ELEMENTS WITH 1 ARMREST

ELEMENTO TERMINALE PENISOLA CON FLAP CM 162 OPEN-END ELEMENT WITH 1 ARMREST AND FLAP CM 162

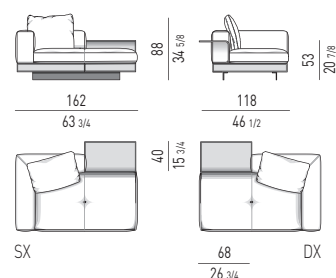

ELEMENTO TERMINALE PENISOLA CON FLAP CM 230 OPEN-END ELEMENT WITH 1 ARMREST AND FLAP CM 230

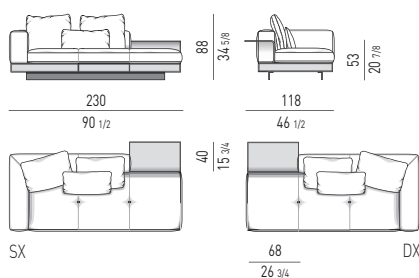

ELEMENTI PENISOLA | OPEN-END ELEMENTS

ELEMENTO PENISOLA CM 140 OPEN-END ELEMENT CM 140

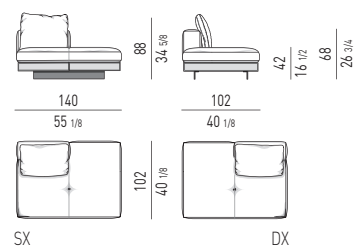

ELEMENTO PENISOLA CON FLAP CM 140 OPEN-END ELEMENT WITH FLAP CM 140

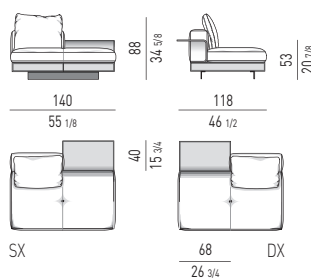

ELEMENTO PENISOLA CM 208 OPEN-END ELEMENT CM 208

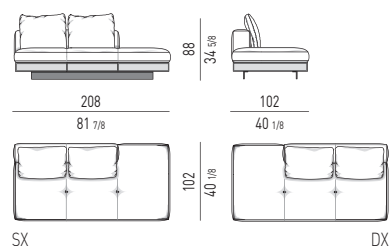

ELEMENTO PENISOLA CON FLAP CM 208 OPEN-END ELEMENT WITH FLAP CM 208

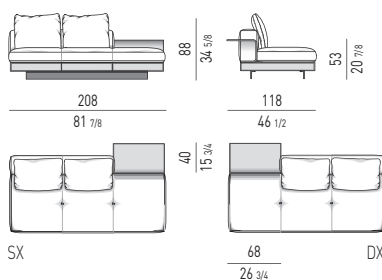

ELEMENTI CENTRALI | CENTRAL ELEMENTS

ELEMENTO CENTRALE CM 140 CENTRAL ELEMENT CM 140

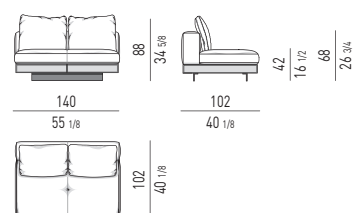

ELEMENTO CENTRALE CM 208 CENTRAL ELEMENT CM 208

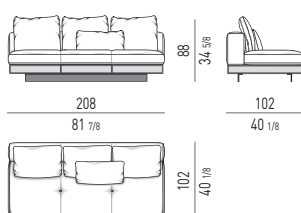

ELEMENTO CENTRALE OPEN CON FLAP CM 208 OPEN CENTRAL ELEMENT WITH FLAP CM 208

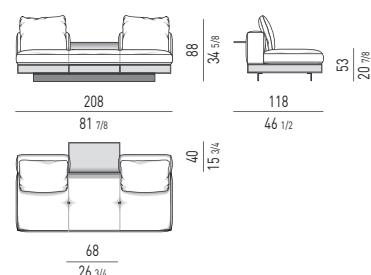

DIVANI ANGOLARI | CORNER SOFAS

DIVANO ANGOLORE CM **261X102**
CORNER SOFA CM **261X102**

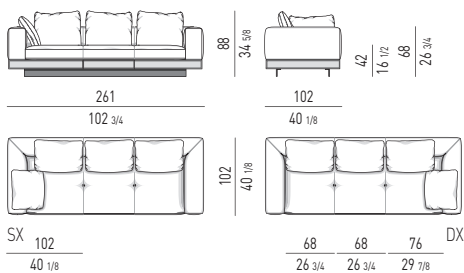

DIVANO ANGOLORE CON **FLAP** CM **277X102**
CORNER SOFA WITH **FLAP** CM **277X102**

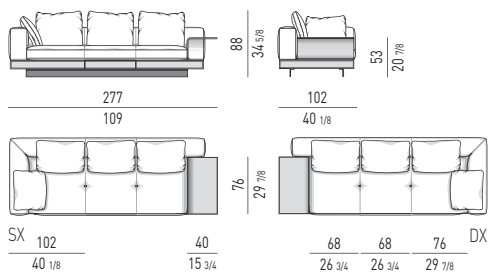

DIVANI ANGOLARI-DAYBED | CORNER SOFAS-DAYBED

DIVANO ANGOLORE-DAYBED CON **FLAP** CM **261X118** - SCHIENALE CM **167**
CORNER SOFA-DAYBED WITH **FLAP** CM **261X118** - BACKREST CM **167**

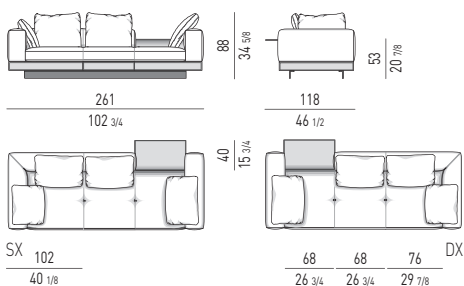

DIVANO ANGOLORE-DAYBED CON **FLAP** CM **261X118** - SCHIENALE CM **159**
CORNER SOFA-DAYBED WITH **FLAP** CM **261X118** - BACKREST CM **159**

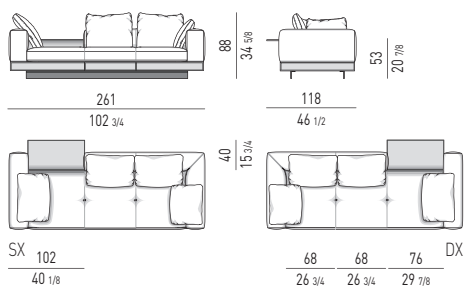

ELEMENTO ANGOLORE TERMINALE-DAYBED | CORNER ELEMENT WITH 1 ARMREST-DAYBED

ELEMENTO ANGOLORE TERMINALE-DAYBED CON **FLAP** CM **239X118**
CORNER ELEMENT WITH 1 ARMREST-DAYBED AND **FLAP** CM **239X118**

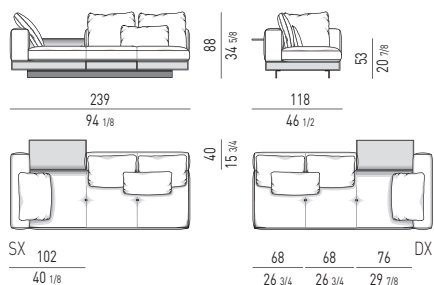

ELEMENTI ANGOLARI TERMINALI | CORNER ELEMENTS WITH 1 ARMREST

ELEMENTO ANGOLORE TERMINALE CM **171X102**
CORNER ELEMENT WITH 1 ARMREST CM **171X102**

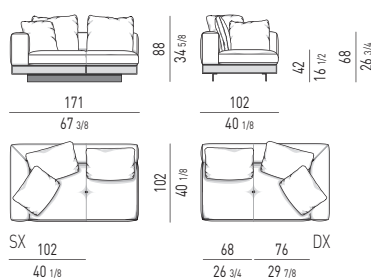

ELEMENTO ANGOLORE TERMINALE CM **239X102**
CORNER ELEMENT WITH 1 ARMREST CM **239X102**

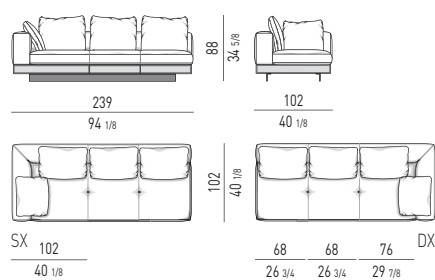

Minotti

ELEMENTI ANGOLARI TERMINALI PENISOLA | CORNER OPEN-END ELEMENTS WITH 1 ARMREST

ELEMENTO ANGOLARE TERMINALE PENISOLA CM **171X102**
CORNER OPEN-END ELEMENT WITH 1 ARMREST CM **171X102**

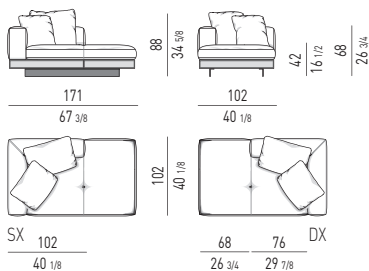

ELEMENTO ANGOLARE TERMINALE PENISOLA CON **FLAP** CM **171X118**
CORNER OPEN-END ELEMENT WITH 1 ARMREST AND **FLAP** CM **171X118**

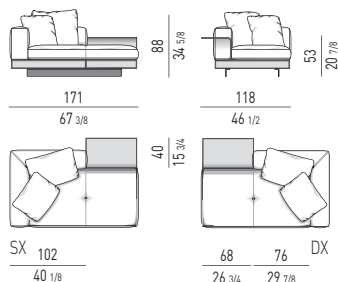

ELEMENTO ANGOLARE TERMINALE PENISOLA CM **239X102**
CORNER OPEN-END ELEMENT WITH 1 ARMREST CM **239X102**

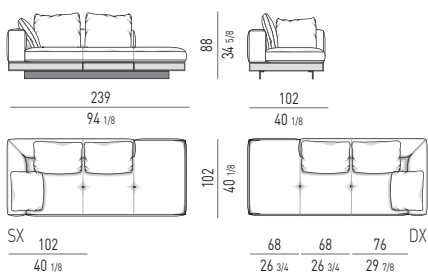

ELEMENTO ANGOLARE TERMINALE PENISOLA CON **FLAP** CM **239X118**
CORNER OPEN-END ELEMENT WITH 1 ARMREST AND **FLAP** CM **239X118**

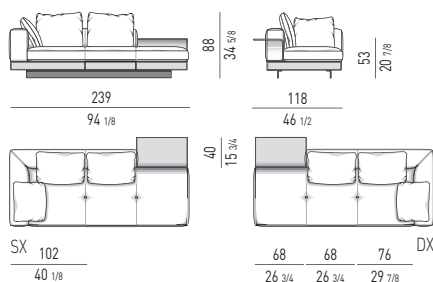

PANCHE | BENCHES

PANCA CON BRACCIOLO CM **162X80**
BENCH WITH ARMREST CM **162X80**

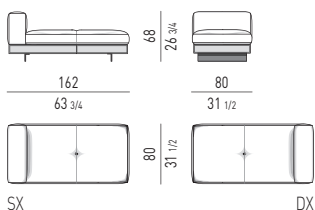

PANCA CON **FLAP** CM **178X80**
BENCH WITH **FLAP** CM **178X80**

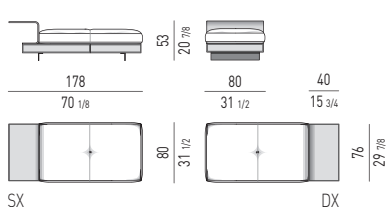

PANCA CM **140X80**
BENCH CM **140X80**

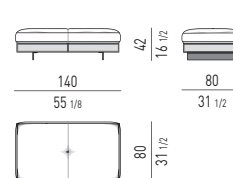

POUF | OTTOMAN

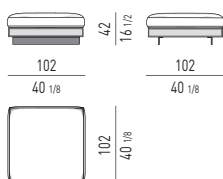

CHAISE-LONGUES

CHAISE-LONGUES SQUARE SMALL

CHAISE-LONGUE SQUARE **SMALL CM 157X157**
 CHAISE-LONGUE SQUARE **SMALL CM 157X157**

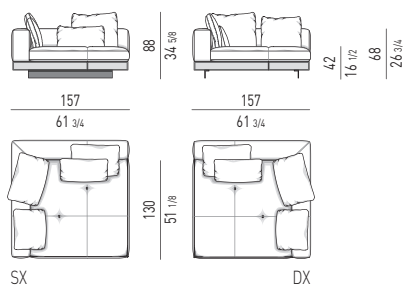

CHAISE-LONGUE SQUARE **SMALL CON FLAP CM 173X157**
 CHAISE-LONGUE SQUARE **SMALL WITH FLAP CM 173X157**

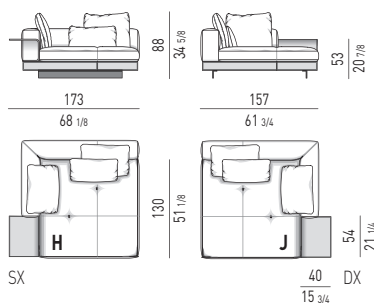

CHAISE-LONGUES SQUARE LARGE

CHAISE-LONGUE SQUARE **SMALL CON FLAP CM 157X173**
 CHAISE-LONGUE SQUARE **SMALL WITH FLAP CM 157X173**

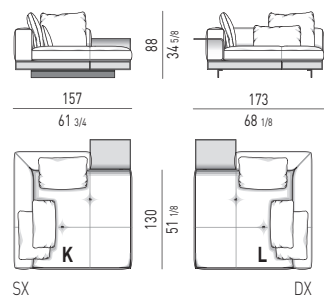

CHAISE-LONGUE SQUARE **LARGE CM 178X178**
 CHAISE-LONGUE SQUARE **LARGE CM 178X178**

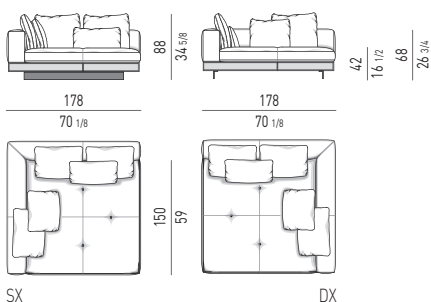

CHAISE-LONGUE SQUARE **LARGE CON FLAP CM 194X178**
 CHAISE-LONGUE SQUARE **LARGE WITH FLAP CM 194X178**

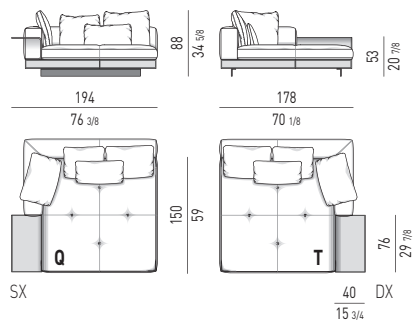

CHAISE-LONGUE SQUARE **LARGE CON FLAP CM 178X194**
 CHAISE-LONGUE SQUARE **LARGE WITH FLAP CM 178X194**

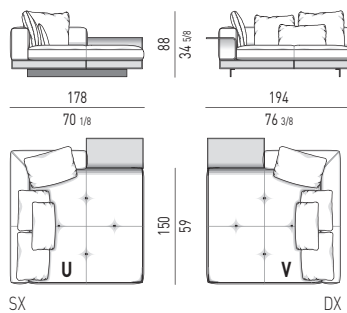

CHAISE-LONGUE SQUARE **LARGE CON FLAP CM 194X178**
 CHAISE-LONGUE SQUARE **LARGE WITH FLAP CM 194X178**

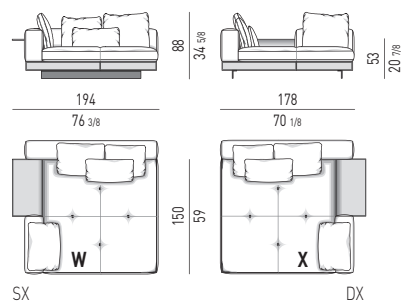

CHAISE-LONGUE SQUARE **LARGE CON FLAP CM 178X194**
 CHAISE-LONGUE SQUARE **LARGE WITH FLAP CM 178X194**

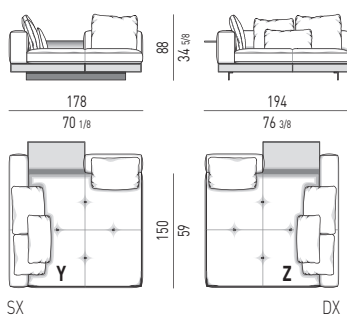

Minotti

CHAISE-LONGUES ROUND

CHAISE-LONGUE ROUND **SMALL CM 165X165**
CHAISE-LONGUE ROUND **SMALL CM 165X165**

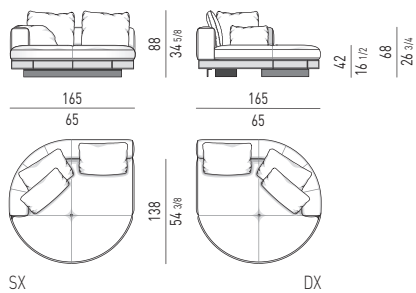

CHAISE-LONGUE ROUND **LARGE CM 181X181**
CHAISE-LONGUE ROUND **LARGE CM 181X181**

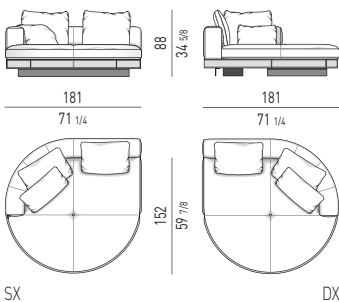

CHAISE-LONGUE **CIRCLE CM 166X181**
CHAISE-LONGUE **CIRCLE CM 166X181**

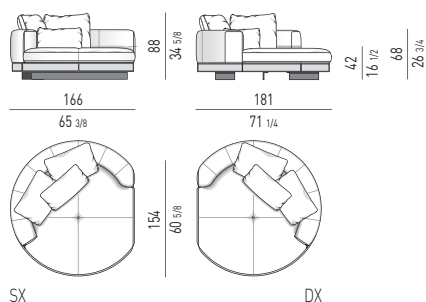

ISOLA **CIRCLE CM 181X181**
CIRCLE ISLAND CM 181X181

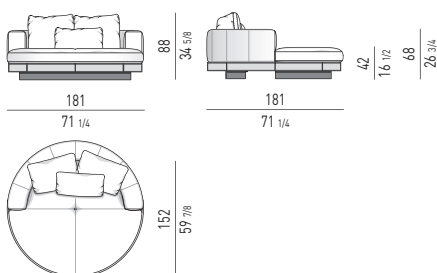

CUSCINI SCHIENALE OPTIONAL OPTIONAL BACKREST CUSHIONS



CUSCINI OPTIONAL OPTIONAL CUSHIONS



VASSOIO OPTIONAL OPTIONAL TRAY

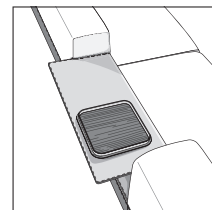
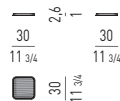

POGGIATESTA OPTIONAL | OPTIONAL HEADRESTS

POGGIATESTA OPTIONAL **CM 90**
(CHAISE-LONGUE ROUND SMALL/LARGE E CIRCLE, ISOLA CIRCLE)

OPTIONAL HEADREST **CM 90**
(CHAISE-LONGUE ROUND SMALL/LARGE AND CIRCLE, CIRCLE ISLAND)

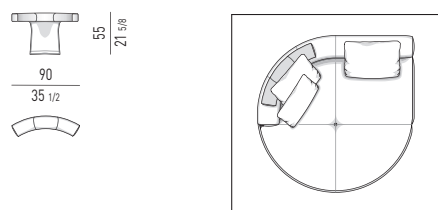

POGGIATESTA OPTIONAL **CM 60** (SEDUTA CM 68)
OPTIONAL HEADREST **CM 60** (SEAT CM 68)

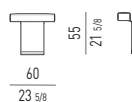

POGGIATESTA OPTIONAL **CM 70** (SEDUTA CM 83)
OPTIONAL HEADREST **CM 70** (SEAT CM 83)

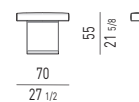

POSIZIONE POGGIATESTA | HEADREST POSITION

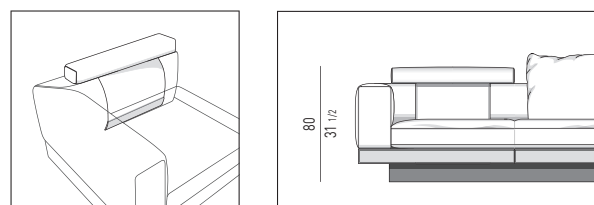



- A**
- 1 Chaise-Longue Square LARGE con FLAP sx cm 194x178 H88
 - 1 elemento angolare terminale dx cm 269x102 H88 modulo seduta cm 83
 - 1 elemento terminale penisola con FLAP dx cm 275x118 H88 - modulo seduta cm 83
 - 1 poltrona Torii MEDIUM girevole cm 88x88 H72
 - 1 pouf Torii SMALL Ø cm 64 H42
 - 1 tavolino Flirt cm 37x30 H52
 - 1 contenitore orizzontale Darren Living/Tv con 3 cassettoni cm 277x56 H54,5 - versione LEGS
 - 1 tavolino Boteco cm 140x140 H22
 - 1 tavolino/pouf Solid Saddle-hide cm 35x35 H45
 - 1 tappeto Dibbets Barcode cm 600x500
- 1 Chaise-Longue Square LARGE mit FLAP sx cm 194x178 H88
 - 1 Eckelement mit 1 Armlehne dx cm 269x102 H88 Sitzkissen cm 83
 - 1 Halbinselement mit 1 Armlehne und FLAP dx cm 275x118 H88 - Sitzkissen cm 83
 - 1 Sessel Torii MEDIUM drehbar cm 88x88 H72
 - 1 Hocker Torii SMALL Ø cm 64 H42
 - 1 Beistelltisch Flirt cm 37x30 H52
 - 1 Horizontales Sideboard Darren Living/Tv mit 3 Schubladen cm 277x56 H54,5 - LEGS Ausführung
 - 1 Beistelltisch Boteco cm 140x140 H22
 - 1 Beistelltisch/Hocker Solid Saddle-hide cm 35x35 H45
 - 1 Teppich Dibbets Barcode cm 600x500
- 1 Chaise-Longue Square LARGE with FLAP sx cm 194x178 H88
 - 1 corner element with 1 armrest dx cm 269x102 H88 seating module cm 83
 - 1 open-end element with 1 armrest and FLAP dx cm 275x118 H88 - seating module cm 83
 - 1 Torii MEDIUM swivel armchair cm 88x88 H72
 - 1 Torii SMALL ottoman Ø cm 64 H42
 - 1 Flirt side table cm 37x30 H52
 - 1 Darren Living/Tv horizontal sideboard with 3 drawers cm 277x56 H54,5 - LEGS version
 - 1 Boteco coffee table cm 140x140 H22
 - 1 Solid Saddle-hide coffee table/stool cm 35x35 H45
 - 1 Dibbets Barcode rug cm 600x500
- 1 Chaise-Longue Square LARGE avec FLAP sx cm 194x178 H88
 - 1 élément d'angle avec 1 accoudoir dx cm 269x102 H88 - coussin de siège cm 83
 - 1 élément îlot avec accoudoir et FLAP dx cm 275x118 H88 - coussin de siège cm 83
 - 1 fauteuil Torii MEDIUM pivotant cm 88x88 H72
 - 1 pouf Torii SMALL Ø cm 64 H42
 - 1 petite table Flirt cm 37x30 H52
 - 1 bahut horizontal Darren Living/Tv avec 3 tiroirs cm 277x56 H54,5 - version LEGS
 - 1 petite table Boteco cm 140x140 H22
 - 1 petite table/pouf Solid Saddle-hide cm 35x35 H45
 - 1 tapis Dibbets Barcode cm 600x500

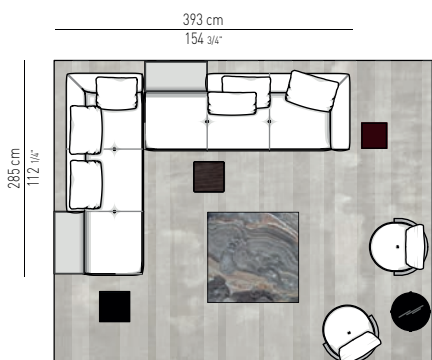

- B**
- 1 elemento angolare terminale penisola con FLAP dx cm 269x118 H88 - modulo seduta cm 83
 - 1 elemento terminale penisola con FLAP dx cm 275x118 H88 - modulo seduta cm 83
 - 2 poltrone Torii Nest girevoli cm 75x77 H77
 - 1 tavolino Torii Ø cm 50 H30
 - 1 tavolino Liam cm 40x40 H60
 - 1 tavolino Liam cm 120x120 H28
 - 1 tavolino Kyle cm 40x40 H45
 - 1 tavolino Solid cm 35x35 H45
 - 1 tappeto Dibbets Barcode cm 500x400
- 1 corner open-end element with 1 armrest and FLAP dx cm 269x118 H88 - seating module cm 83
 - 1 open-end element with 1 armrest and FLAP dx cm 275x118 H88 - seating module cm 83
 - 2 Torii Nest swivel armchairs cm 75x77 H77
 - 1 Torii side table Ø cm 50 H30
 - 1 Liam side table cm 40x40 H60
 - 1 Liam coffee table cm 120x120 H28
 - 1 Kyle side table cm 40x40 H45
 - 1 Solid side table cm 35x35 H45
 - 1 Dibbets Barcode rug cm 500x400
- 1 Eckelement mit 1 Armlehne und FLAP-Halbinselement dx cm 269x118 H88 Sitzkissen cm 83
 - 1 Halbinselement mit 1 Armlehne und FLAP dx cm 275x118 H88 - Sitzkissen cm 83
 - 2 Sessel Torii Nest drehbar cm 75x77 H77
 - 1 Beistelltisch Torii Ø cm 50 H30
 - 1 Beistelltisch Liam cm 40x40 H60
 - 1 Beistelltisch Liam cm 120x120 H28
 - 1 Beistelltisch Kyle cm 40x40 H45
 - 1 Beistelltisch Solid cm 35x35 H45
 - 1 Teppich Dibbets Barcode cm 500x400
- 1 élément îlot d'angle avec 1 accoudoir et FLAP dx cm 269x118 H88 - coussin de siège cm 83
 - 1 élément îlot avec accoudoir et FLAP dx cm 275x118 H88 - coussin de siège cm 83
 - 2 fauteuils Torii Nest pivotant cm 75x77 H77
 - 1 petite table Torii Ø cm 50 H30
 - 1 petite table Liam cm 40x40 H60
 - 1 petite table Liam cm 120x120 H28
 - 1 petite table Kyle cm 40x40 H45
 - 1 petite table Solid cm 35x35 H45
 - 1 tapis Dibbets Barcode cm 500x400

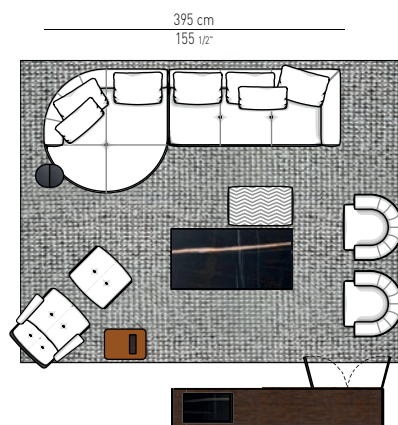

- C**
- 1 Chaise-Longue Round SMALL sx cm 165x165 H88
 - 1 elemento terminale dx cm 230x102 H88 modulo seduta cm 68
 - 1 poltrona Daiki cm 93x91 H69
 - 1 poggiatesta Daiki cm 67x64 H40
 - 2 poltrone Mattia Lounge cm 87x79 H67
 - 1 contenitore Boteco orizzontale Living con 2 ante cm 280x50 H60
 - 1 tavolino Flirt cm 37x30 H52
 - 1 tavolino Block cm 55x40 H45
 - 1 tavolino Linha cm 160x80 H28
 - 1 pouf Quincy Chevron cm 86x52 H38
 - 1 tappeto Osaka cm 500x400

- 1 Chaise-Longue Round SMALL sx cm 165x165 H88
- 1 Endelement mit 1 Armlehne dx cm 230x102 H88 - Sitzkissen cm 68
- 1 Sessel Daiki cm 93x91 H69
- 1 Hocker Daiki cm 67x64 H40
- 2 Sessel Mattia Lounge cm 87x79 H67
- 1 Horizontales Sideboard Boteco Living mit 2 Türen cm 280x50 H60
- 1 Beistelltisch Flirt cm 37x30 H52
- 1 Beistelltisch Block cm 55x40 H45
- 1 Beistelltisch Linha cm 160x80 H28
- 1 Hocker Quincy Chevron cm 86x52 H38
- 1 Teppich Osaka cm 500x400

- 1 Chaise-Longue Round SMALL sx cm 165x165 H88
- 1 element with 1 armrest dx cm 230x102 H88 seating module cm 68
- 1 Daiki armchair cm 93x91 H69
- 1 Daiki footstool cm 67x64 H40
- 2 Mattia Lounge armchairs cm 87x79 H67
- 1 Boteco Living horizontal sideboard with 2 doors cm 280x50 H60
- 1 Flirt side table cm 37x30 H52
- 1 Block side table cm 55x40 H45
- 1 Linha coffee table cm 160x80 H28
- 1 Quincy Chevron ottoman cm 86x52 H38
- 1 Osaka rug cm 500x400

- 1 Chaise-Longue Round SMALL sx cm 165x165 H88
- 1 élément avec 1 accoudoir dx cm 230x102 H88 coussin de siège cm 68
- 1 fauteuil Daiki cm 93x91 H69
- 1 repose-pied Daiki cm 67x64 H40
- 2 fauteuils Mattia Lounge cm 87x79 H67
- 1 bahut horizontal Boteco Living avec 2 portes cm 280x50 H60
- 1 petite table Flirt cm 37x30 H52
- 1 petite table Block cm 55x40 H45
- 1 petite table Linha cm 160x80 H28
- 1 pouf Quincy Chevron cm 86x52 H38
- 1 tapis Osaka cm 500x400

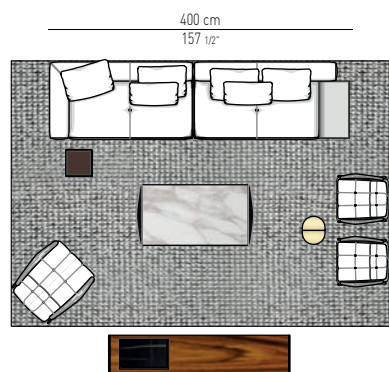

- D**
- 1 elemento terminale sx cm 192x102 H88 modulo seduta cm 83
 - 1 elemento terminale con FLAP dx cm 208x102 H88 modulo seduta cm 83
 - 1 poltrona Fynn cm 82x93 H76
 - 2 poltroncine Fynn Saddle-Hide Lounge cm 67x69 H75
 - 1 consolle Boteco Living/Tv DX cm 240x50 H55
 - 1 tavolino/pouf Solid Saddle-hide cm 35x35 H45
 - 1 tavolino Fynn cm 155x80 H28
 - 1 tavolino Flirt cm 37x30 H52
 - 1 tappeto Osaka cm 500x350

- 1 Endelement mit 1 Armlehne sx cm 192x102 H88 Sitzkissen cm 83
- 1 Endelement mit 1 Armlehne und FLAP dx cm 208x102 H88 - Sitzkissen cm 83
- 1 Sessel Fynn cm 82x93 H76
- 2 Kleiner Armsessel Fynn Saddle-hide Lounge cm 67x69 H75
- 1 Living/Tv Konsole Boteco DX cm 240x50 H55
- 1 Beistelltisch/Hocker Solid Saddle-hide cm 35x35 H45
- 1 Beistelltisch Fynn cm 155x80 H28
- 1 Beistelltisch Flirt cm 37x30 H52
- 1 Teppich Osaka cm 500x350

- 1 element with 1 armrest sx cm 192x102 H88 seating module cm 83
- 1 element with 1 armrest and FLAP dx cm 208x102 H88 - seating module cm 83
- 1 Fynn armchair cm 82x93 H76
- 2 Fynn Saddle-hide Lounge little armchairs cm 67x69 H75
- 1 Boteco Living/Tv console table DX cm 240x50 H55
- 1 Solid Saddle-hide coffee table/stool cm 35x35 H45
- 1 Fynn coffee table cm 155x80 H28
- 1 Flirt side table cm 37x30 H52
- 1 Osaka rug cm 500x350

- 1 élément avec 1 accoudoir sx cm 192x102 H88 coussin de siège cm 83
- 1 élément avec 1 accoudoir et FLAP dx cm 208x102 H88 - coussin de siège cm 83
- 1 fauteuil Fynn cm 82x93 H76
- 2 petits fauteuils Fynn Saddle-Hide Lounge cm 67x69 H75
- 1 console Boteco Living/Tv DX cm 240x50 H55
- 1 petite table/pouf Solid Saddle-hide cm 35x35 H45
- 1 petite table Fynn cm 155x80 H28
- 1 petite table Flirt cm 37x30 H52
- 1 tapis Osaka cm 500x350

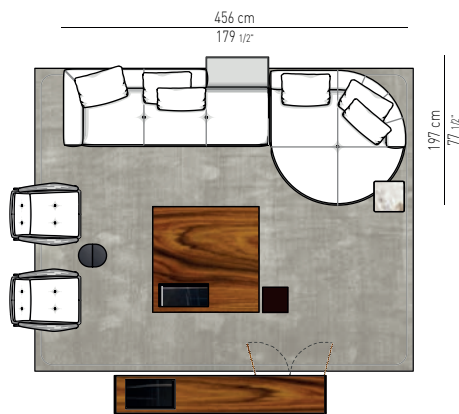

- E**
- 1 elemento terminale penisola con FLAP sx cm 275x118 H88 - modulo seduta cm 83
 - 1 Chaise-Longue Round LARGE dx cm 181x181 H88
 - 2 poltrone Fynn Saddle-hide cm 82x93 H76
 - 1 tavolino Flirt cm 37x30 H52
 - 1 contenitore Boteco orizzontale Living con 2 ante cm 280x50 H60
 - 1 tavolino Boteco cm 140x140 H22
 - 1 tavolino Solid cm 35x35 H45
 - 1 tavolino Kyle cm 40x40 H45
 - 1 tappeto Outline cm 500x400
- 1 Halbinselement mit 1 Armlehne und FLAP sx cm 275x118 H88 - Sitzkissen cm 83
 - 1 Chaise-Longue Round LARGE dx cm 181x181 H88
 - 2 Sessel Fynn Saddle-hide cm 82x93 H76
 - 1 Beistelltisch Flirt cm 37x30 H52
 - 1 Living horizontales Sideboard Boteco mit 2 Türen cm 280x50 H60
 - 1 Beistelltisch Boteco 140x140 H22
 - 1 Beistelltisch Solid cm 35x35 H45
 - 1 Beistelltisch Kyle cm 40x40 H45
 - 1 Teppich Outline cm 500x400
- 1**
- open-end element with 1 armrest and FLAP sx cm 275x118 H88 - seating module cm 83
 - 1 Chaise-Longue Round LARGE dx cm 181x181 H88
 - 2 Fynn Saddle-hide armchairs cm 82x93 H76
 - 1 Flirt side table cm 37x30 H52
 - 1 Boteco Living horizontal sideboard with 2 doors cm 280x50 H60
 - 1 Boteco coffee table cm 140x140 H22
 - 1 Solid side table cm 35x35 H45
 - 1 Kyle side table cm 40x40 H45
 - 1 Outline rug cm 500x400
- 1**
- élément îlot avec accoudoir et FLAP sx cm 275x118 H88 - coussin de siège cm 83
 - 1 Chaise-Longue Round LARGE dx cm 181x181 H88
 - 2 fauteuils Fynn Saddle-hide cm 82x93 H76
 - 1 petite table Flirt cm 37x30 H52
 - 1 bahut horizontal Boteco Living avec 2 portes cm 280x50 H60
 - 1 petite table Boteco cm 140x140 H22
 - 1 petite table Solid cm 35x35 H45
 - 1 petite table Kyle cm 40x40 H45
 - 1 tapis Outline cm 500x400

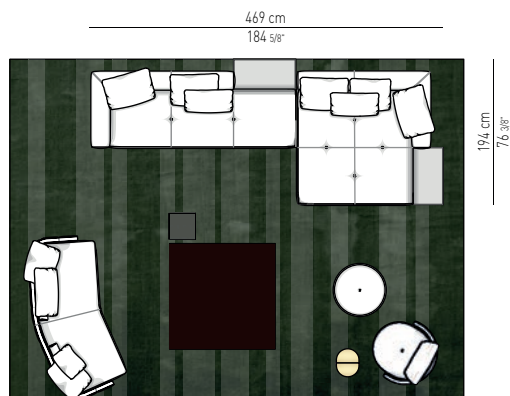

- F**
- 1 elemento terminale penisola con FLAP sx cm 275x118 H88 - modulo di seduta cm 83
 - 1 Chaise-Longue Square LARGE dx con FLAP cm 194x178 H88
 - 1 divano Torii curvo LOW cm 220x105 H87
 - 1 poltrona Torii MEDIUM girevole cm 88x88 H72
 - 1 pouf Torii MEDIUM Ø cm 70 H42
 - 1 tavolino contenitore Solid con 2 cassetti cm 140x140 H30
 - 1 tavolino/pouf Solid Saddle-hide cm 35x35 H45
 - 1 tavolino Flirt cm 37x30 H52
 - 1 tappeto Dibbets Barcode cm 600x450
- 1 Halbinselement mit 1 Armlehne und FLAP sx cm 275x118 H88 - Sitzkissen cm 83
 - 1 Chaise-Longue Square LARGE dx mit FLAP cm 194x178 H88
 - 1 Rundes Sofa Torii LOW cm 220x105 H87
 - 1 Sessel Torii MEDIUM drehbar cm 88x88 H72
 - 1 Hocker Torii MEDIUM Ø cm 70 H42
 - 1 Beistelltisch/Behälter Solid mit 2 Schubladen cm 140x140 H30
 - 1 Beistelltisch/Hocker Solid Saddle-hide cm 35x35 H45
 - 1 Beistelltisch Flirt cm 37x30 H52
 - 1 Teppich Dibbets Barcode cm 600x450
- 1**
- open-end element with 1 armrest and FLAP sx cm 275x118 H88 - seating module cm 83
 - 1 Chaise-Longue Square LARGE dx with FLAP cm 194x178 H88
 - 1 Torii LOW angled sofa cm 220x105 H87
 - 1 Torii MEDIUM swivel armchair cm 88x88 H72
 - 1 Torii MEDIUM ottoman Ø cm 70 H42
 - 1 Solid storage coffee table with 2 drawers cm 140x140 H30
 - 1 Solid Saddle-hide coffee table/stool cm 35x35 H45
 - 1 Flirt side table cm 37x30 H52
 - 1 Dibbets Barcode rug cm 600x450
- 1**
- élément îlot avec accoudoir et FLAP sx cm 275x118 H88 - coussin de siège cm 83
 - 1 Chaise-Longue Square LARGE dx avec FLAP cm 194x178 H88
 - 1 canapé Torii rond LOW cm 220x105 H87
 - 1 fauteuil Torii MEDIUM pivotant cm 88x88 H72
 - 1 pouf Torii MEDIUM Ø cm 70 H42
 - 1 petite table récipient Solid avec 2 tiroirs cm 140x140 H30
 - 1 petite table/pouf Solid Saddle-hide cm 35x35 H45
 - 1 petite table Flirt cm 37x30 H52
 - 1 tapis Dibbets Barcode cm 600x450

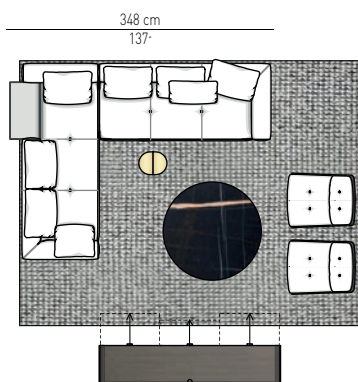

- G**
- 1 divano angolare-Daybed con FLAP dx cm 261x118 H88 schienale cm 159 modulo seduta cm 68
 - 1 elemento terminale dx cm 230x102 H88 modulo seduta cm 68
 - 2 poltrone Daiki senza braccioli cm 72x91 H69
 - 1 contenitore orizzontale Darren Living/Tv con 3 cassettoni cm 240x56 H54,5 - versione LEGS
 - 1 tavolino Flirt cm 37x30 H52
 - 1 tavolino Linha Ø cm 130 H28
 - 1 tappeto Osaka cm 450x350
 - 1 Daybed-Ecksofa mit FLAP dx cm 261x118 H88 Armlehne cm 159 - Sitzkissen cm 68
 - 1 Endelement mit 1 Armlehne dx cm 230x102 H88 Sitzkissen cm 68
 - 2 Sessel Daiki ohne Armlehnen cm 72x91 H69
 - 1 Living/Tv Horizontales Sideboard Darren mit 3 Schubladen cm 240x56 H54,5 - LEGS Ausführung
 - 1 Beistelltisch Flirt cm 37x30 H52
 - 1 Beistelltisch Linha Ø cm 130 H28
 - 1 Teppich Osaka cm 450x350
 - 1 divan d'angle-Daybed avec FLAP dx cm 261x118 H88 dossier cm 159 - coussin de siège cm 68
 - 1 élément avec 1 accoudoir dx cm 230x102 H88 coussin de siège cm 68
 - 2 fauteuils Daiki sans accoudoirs cm 72x91 H69
 - 1 bahut horizontal Darren Living/Tv avec 3 tiroirs cm 240x56 H54,5 - version LEGS
 - 1 petite table Flirt cm 37x30 H52
 - 1 petite table Linha Ø cm 130 H28
 - 1 tapis Osaka cm 450x350

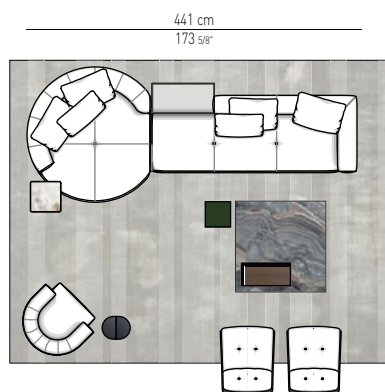

- H**
- 1 Chaise-Longue Circle sx cm 166x181 H88
 - 1 elemento terminale penisola con FLAP dx cm 275x118 H88 - modulo seduta cm 83
 - 1 poltrona Mattia cm 90x85 H67
 - 2 poltrone Daiki senza braccioli cm 72x91 H69
 - 1 tavolino Kyle cm 40x40 H45
 - 1 tavolino Flirt cm 37x30 H52
 - 1 tavolino Solid cm 35x35 H45
 - 1 tavolino Boteco cm 120x120 H22
 - 1 tappeto Dibbets Barcode cm 500x400
 - 1 Chaise-Longue Circle sx cm 166x181 H88
 - 1 Halbinselement mit 1 Armlehne und FLAP dx cm 275x118 H88 - Sitzkissen cm 83
 - 1 Sessel Mattia cm 90x85 H67
 - 2 Sessel Daiki ohne Armlehnen cm 72x91 H69
 - 1 Beistelltisch Kyle cm 40x40 H45
 - 1 Beistelltisch Flirt cm 37x30 H52
 - 1 Beistelltisch Solid cm 35x35 H45
 - 1 Beistelltisch Boteco cm 120x120 H22
 - 1 Teppich Dibbets Barcode cm 500x400
 - 1 Chaise-Longue Circle sx cm 166x181 H88
 - 1 open-end element with 1 armrest and FLAP dx cm 275x118 H88 - seating module cm 83
 - 1 Mattia armchair cm 90x85 H67
 - 2 Daiki armchairs without armrests cm 72x91 H69
 - 1 Kyle side table cm 40x40 H45
 - 1 Flirt side table cm 37x30 H52
 - 1 Solid side table cm 35x35 H45
 - 1 Boteco coffee table cm 120x120 H22
 - 1 Dibbets Barcode rug cm 500x400
 - 1 Chaise-Longue Circle sx cm 166x181 H88
 - 1 élément îlot avec accoudoir et FLAP dx cm 275x118 H88 - coussin de siège cm 83
 - 1 fauteuil Mattia cm 90x85 H67
 - 2 fauteuils Daiki sans accoudoirs cm 72x91 H69
 - 1 petite table Kyle cm 40x40 H45
 - 1 petite table Flirt cm 37x30 H52
 - 1 petite table Solid cm 35x35 H45
 - 1 petite table Boteco cm 120x120 H22
 - 1 tapis Dibbets Barcode cm 500x400